

SEPTEMBER  
1947  
35c

*Band switching J-F-O Also VFO*  
*Phone Amp better*  
*2 meter Power*  
**RADIO  
NEWS**

**How To Build  
AN INEXPENSIVE  
TELEVISION RECEIVER**

Page 39



RN-57-160769-48  
LAURENCE THORSON  
DALLAS WIS

Accent on

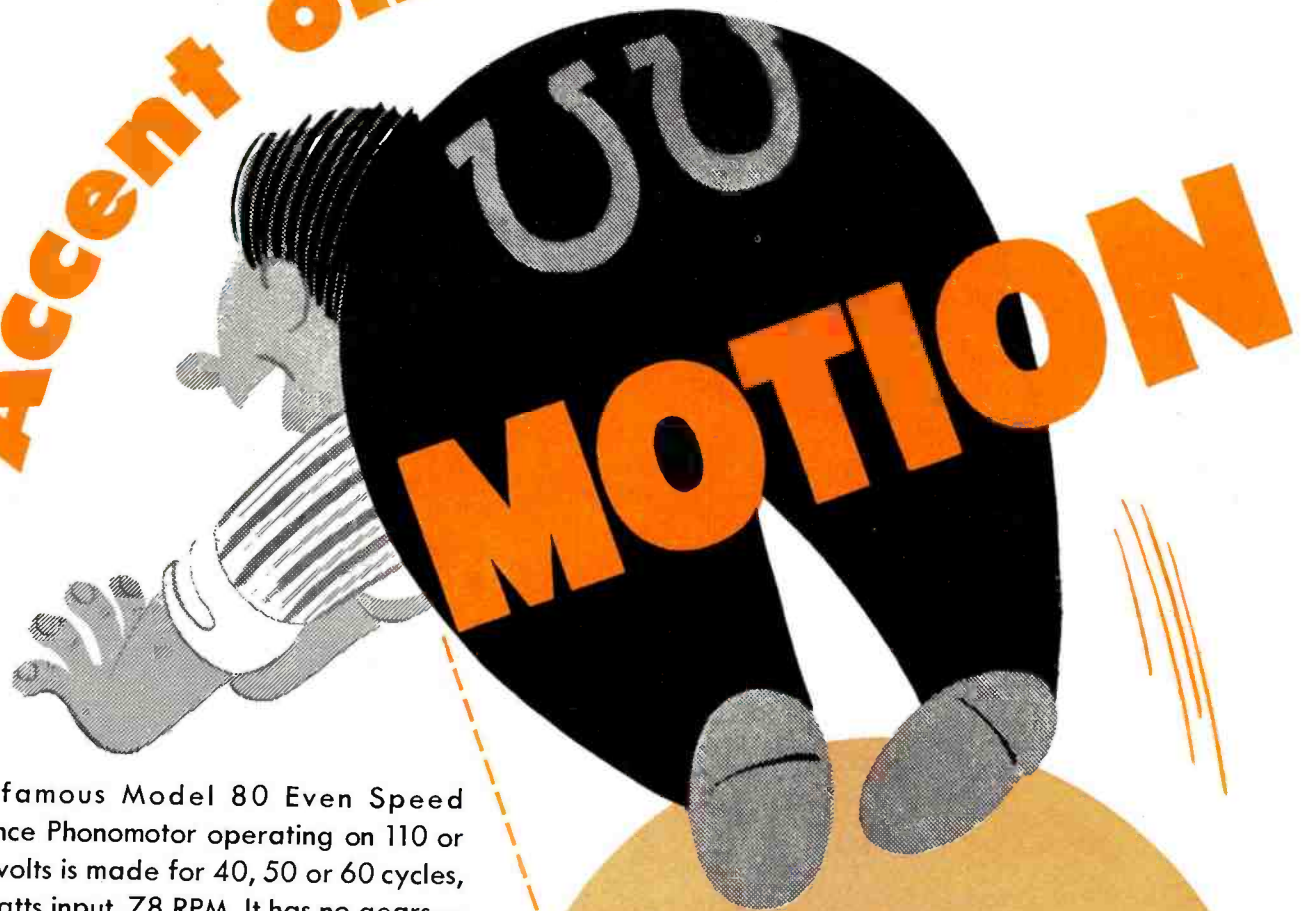

The famous Model 80 Even Speed Alliance Phonomotor operating on 110 or 220 volts is made for 40, 50 or 60 cycles, 16 watts input, 78 RPM. It has no gears—runs at an even speed—has a smooth, quiet, positive friction-rim drive. Ample proportioned bearings with large oil reservoirs assure long life. A slip-type fan gives cool operation—avoids any possible injury.

The Alliance Model K Phonomotor, a 25 cycle companion to the Model 80, operates on 110 volts, 25 cycles at 12 watt input. Motor and idler plate on Alliance phonomotors are all shock mounted to the cabinet mounting plate, to minimize vibration.

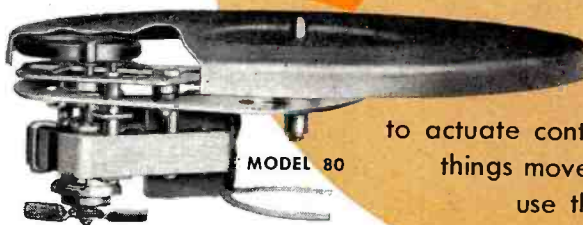

***The trend is to make things move!***

Designs will call for more action—movement! Flexible product performance needs power sources which are compact, light weight! Alliance Powr-Pakt Motors rated from less than 1-400th on up to 1-20th h.p. will fit those “point-of-action” places! Alliance Motors are mass produced at low cost—engineered for small load jobs!

For vital component power links to actuate controls... to make things move... plan to use them!



**WHEN YOU DESIGN—KEEP**

**alliance**

**MOTORS IN MIND**

**ALLIANCE MANUFACTURING COMPANY • ALLIANCE, OHIO**

*Export Department, 401 Broadway, New York 13, N. Y., U. S. A.*



Building this  
**A. M. SIGNAL GENERATOR**  
gives you valuable experience.  
Provides amplitude-modulated  
signals for test and experiment  
purposes.

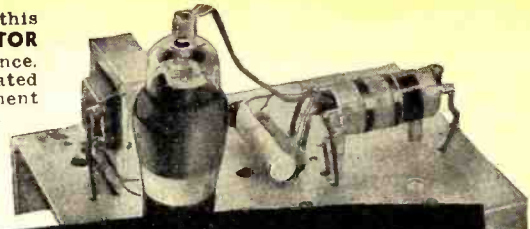

**RADIO SERVICING**  
pays good money for full-time work.  
Many others make \$5, \$10 a week EXTRA  
fixing Radios in spare time.

**VETERANS**

You can get this training right  
in your own home under G. I.  
Bill. Mail coupon for full details.

# Learn RADIO by PRACTICING in Spare Time

## with Big Kits of Radio Parts I Send You

Do you want a good-pay job in Radio—or your own money-making Radio Shop? Mail Coupon for a FREE Sample Lesson and my FREE 64-page book, "How to Be a Success in RADIO—Television, Electronics." See how N.R.I. gives you practical Radio experience at home—building, testing, repairing Radios with BIG KITS OF PARTS I send!

**Many Beginners Soon Make Good Extra Money  
in Spare Time While Learning**

The day you enroll I start sending EXTRA MONEY manuals. You LEARN Radio principles from my easy-to-grasp, illustrated lessons—PRACTICE what you learn with parts I send—USE your knowledge to make EXTRA money fixing neighbors' Radios in spare time while still learning! From here it's a short step to your own full-time Radio Shop or a good Radio Job!

**Future for Trained Men Is Bright in Radio,  
Television, Electronics**

It's probably easier to get started in Radio now than ever before because the Radio Repair business is booming. Trained Radio Technicians also find profitable opportunities in Police, Aviation, Marine Radio, Broadcasting, Radio Manufacturing, Public Address work. Think of even greater opportunities as Television and Electronics become available to the public! Send for free books now!

**Find Out What N.R.I. Can Do for You**

Mail Coupon for Sample Lesson and my 64-page book. Read the details about my Course. Read letters from men I trained, telling what they are doing, earning. See how quickly, easily you can get started. No obligation! Just MAIL COUPON NOW in an envelope or paste it on a penny postal. J. E. Smith, President, Dept. 7JR, National Radio Institute, Pioneer Home Study Radio School, Washington 9, D. C.

My Course Includes Training in  
**TELEVISION ★ ELECTRONICS**  
Frequency Modulation



You build this  
**MEASURING INSTRUMENT** yourself early in the course—use it for practical Radio work on neighborhood Radios to pick up EXTRA spare time money!

You build this **SUPERHETERODYNE CIRCUIT** that brings in local and distant stations. You get practical experience putting this set through fascinating tests.

**BE A SUCCESS in RADIO  
I Will Train You at Home**

**Sample Lesson FREE**

Gives hints on Receiver Servicing, Locating Defects, Repair of Loudspeaker, I.F. Transformer, Gang Tuner, Condenser, etc. 31 illustrations. Study it—keep it—use it—without obligation! Mail Coupon NOW for your copy!



**GET BOTH 64 PAGE BOOK  
SAMPLE LESSON FREE**

Mr. J. E. SMITH, President, Dept. 7JR  
National Radio Institute, Washington 9, D. C.  
Mail me FREE, without obligation, Sample Lesson and 64-page book about how to win success in Radio and Television—Electronics. (No salesman will call. Please write plainly.)

Age.....  
Name .....

Address .....

City ..... Zone.... State.....

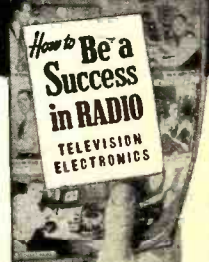

**APPROVED FOR TRAINING UNDER GI BILL**

*Editor*  
**OLIVER READ, W9ETI**  
*Managing Editor*  
**WM. A. STOCKLIN**  
*Technical Editor*  
**H. S. RENNE, EX-W8PTS**  
*Associate Editors*  
**RAY FRANK, W9JU**  
**PAUL WENDEL**  
**FRED HAMLIN**  
**GAITHER LITRELL**  
**P. B. HOEFER**  
**C. M. SULLIVAN**  
*Staff Photographers*  
**ARTHUR E. HAUG**  
**WALTER STEINHARD**  
*Staff Artist*  
**R. S. KUPIACK**

*Advertising Manager*  
**L. L. OSTEN**  
*Midwestern Advertising Manager*  
**JOHN A. RONAN, JR.**

*Art Director*  
**HERMAN R. BOLLIN**



THE COVER: This home-built television receiver was especially designed for Radio News readers. Building this unit will provide much-needed experience for future television service technicians. Photo by Walter Steinhard.

*Chairman of the Board and Publisher*  
**WILLIAM B. ZIFF**

*President*  
**B. G. DAVIS**

*Secretary-Treasurer*  
**ARTHUR T. PULLEN**

*Vice-Presidents*  
**GEORGE BERNER**  
*Advertising and Sales Director*

**MICHAEL H. FROELICH**  
*Editorial Director*

**H. J. MORGANROTH**  
*Production Director*

**H. G. STRONG**  
*Circulation Director*

**BRANCH OFFICES**

**NEW YORK (1)**  
 Empire State Bldg., WI 7-0400

*Manager, Eastern Division*  
**CHARLES R. TIGHE**

**LOS ANGELES (14)**  
 815 S. Hill St., TUcker 9213

*Manager, Western Division*  
**WILLIAM L. PINNEY**

**WASHINGTON (4)**  
 International Bldg., EXecutive 2502

**TORONTO**  
 21 King Street, East

**ASSOCIATED COMPANIES**  
 Ziff Davis, Ltd., Grampians Bldg.  
 Western Gate, London, England  
 Ziff-Davis-Patel, Ltd.  
 190 Hornby Road, Bombay, India

# RADIO NEWS

*First in radio-electronics*

Average Paid Circulation over 135,000

Reg. U. S. Pat. Off.

SEPTEMBER, 1947

## FOR THE SERVICEMAN-DEALER

Servicing Television Receivers.....	Paul H. Wendel	43
Television Installation (Part I).....	W. W. Waye	44
New Radio Outlet Succeeds by Being Different.....	Harry L. Spooner	47
A Practical Vibrator Tester.....	John Bowles	48
Sound Broadcasting from Airplanes.....	Saul J. White	66
Simple Troubleshooting Aid.....	Salvatore J. Mondello	88
Short Change Workers.....	Harold Ziegler	96

## FOR THE AMATEUR

A Bandswitching V.F.O. Exciter.....	Carl Hays, W6RTP	49
Designing a 2 Meter Communication Receiver.....	Robert B. Tomer, W1PIM	57
The 829-B and 832-A at Audio Frequencies.....	James A. Fred	60
A Variable Frequency Oscillator.....	Robert W. Field, W4KAP	65

## OF GENERAL INTEREST

Learn as You Build—Television.....	Arthur Liebscher	39
Television Counters.....	Edward M. Noll	52
Reflective Optical System of Projection Television.....	Dr. V. K. Zworykin	54
A Low Cost Phono Amplifier.....	George R. Cryder	61
The Recording and Reproduction of Sound (Part 7).....	Oliver Read	62

## DEPARTMENTS

For the Record.....	The Editor	8	What's New in Radio.....	78
Spot Radio News.....	Fred Hamlin	16	For the Experimenter.....	108
Within the Industry.....		28	Letters from Our Readers.....	150
Short-Wave.....	K. R. Boord	68	Manufacturers' Literature.....	168
RN Circuit Page.....		76	Technical Books.....	173
New Receivers for Fall Market....		180		



COPYRIGHT 1947  
 ZIFF-DAVIS PUBLISHING COMPANY  
 185 North Wabash Ave., Chicago 1, Ill.  
 VOLUME 38 • NUMBER 3



Member  
 Audit Bureau of  
 Circulations

RADIO NEWS is published monthly by the Ziff-Davis Publishing Company, 185 N. Wabash Ave., Chicago 1, Ill. Subscription Rates: in U. S. and Canada \$4.00 (12 issues), single copies 35 cents; in Mexico, South and Central America, and U.S. Possessions, \$4.00 (12 issues); in British Empire, \$5.00 (12 issues)—all other foreign countries \$5.00 (12 issues). Subscribers should allow at least 2 weeks for change of address. All communications about subscriptions should be addressed to: Director of Circulation, 185 N. Wabash Ave., Chicago 1, Ill. Entered as second class matter March 9, 1938, at the Post Office, Chicago, Illinois, under the Act of March 3, 1879. Entered as second class matter at the Post Office Dept., Ottawa, Canada. Contributors should retain a copy of contributions and include return postage. Accepted material is subject to whatever revisions but this magazine assumes no responsibility for their safety. Accepted rates, covers all authors', contributors', or contestants' rights, title, and interest in and to accepted material, including photos and drawings.

RADIO NEWS

# Presenting the NEW MODEL SX-43

...to give amateurs:

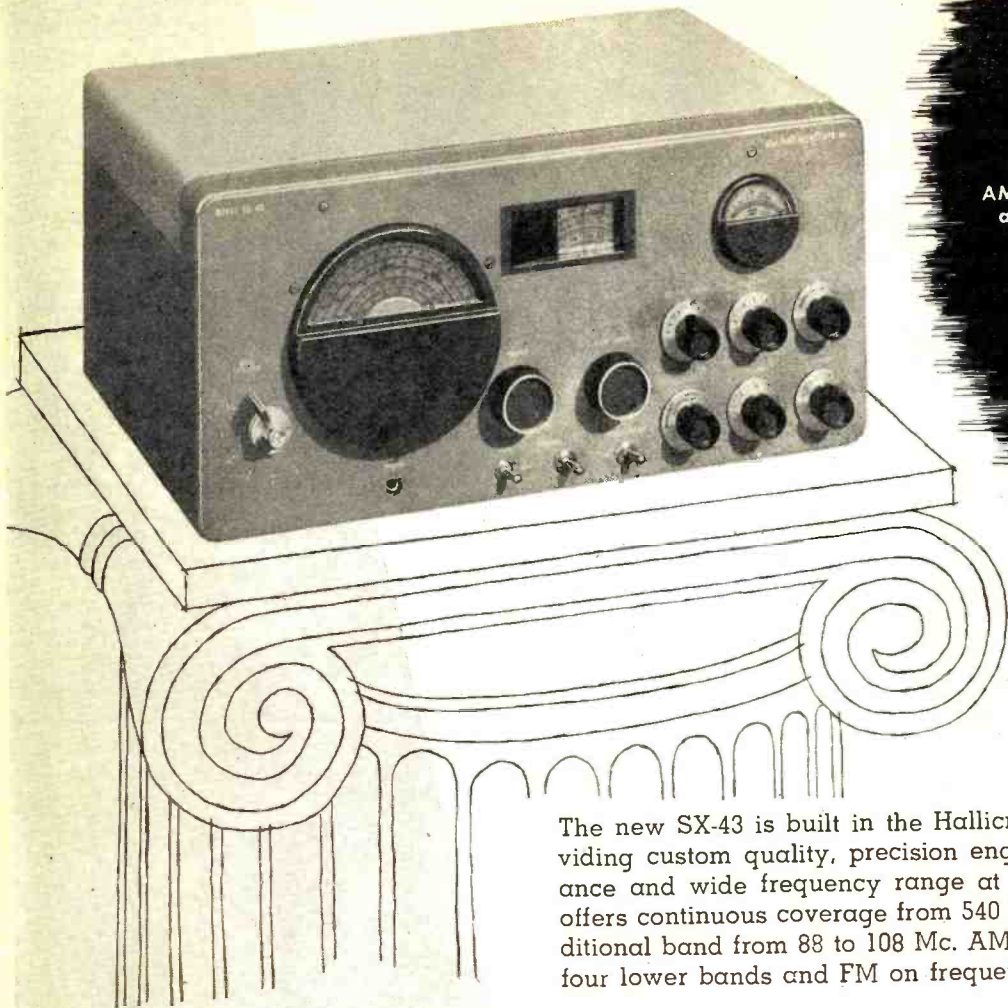

**MORE VALUE**  
 Never before all these features at this price

**GREATER PERFORMANCE**  
 AM-FM-CW . . . all essential amateur frequencies from 540 kc. to 108 Mc.

**LOWER PRICE**  
**\$169<sup>50</sup>**  
 Sets available after August 1947

**Built in the Hallicrafters Classic Tradition**

The new SX-43 is built in the Hallicrafters classic tradition: providing custom quality, precision engineering, excellent performance and wide frequency range at a medium price. The SX-43 offers continuous coverage from 540 kc. to 55 Mc. and has an additional band from 88 to 108 Mc. AM reception all bands. CW on four lower bands and FM on frequencies above 44 Mc.

## New LOW PRICE Transmitter



**\$69<sup>50</sup>**

**MODEL HT-17**

- Ham bands from 3.5 to 30 Mc.
- 15 watts power output on low frequency bands.

Here's real Hallicrafters transmitter performance with maximum convenience and economy. A pi-section matching network, as well as a link, provides coupling to any type of antenna or permits the HT-17 to be used as an exciter for a high power final amplifier. Coil sets extra.

Added technical details on all these models in Hallicrafters New Catalog, No. 38. Ask your local distributor for a copy.

## NEW BETTER QUALITY AM WITH NARROW BAND FM

Exclusively designed - VARIABLE MASTER OSCILLATOR \$110.00 (amateur net)

Here is the hottest transmitter item available today. Packed with outstanding features never before available in one low-priced unit. Add to the HT-18 one or two amplifier stages and you have a complete, high quality transmitter permitting operation on phone or CW up to 1 KW.

MODEL HT-18



Narrow band FM . . . direct frequency calibration . . . finger-tip control of entire station . . . full frequency deviation on all ham bands to 29.7 Mc. . . only 1/10 the distortion of comparable units . . . excellent stability . . . clean keying . . .

BUILDERS OF *Skyfone* AVIATION RADIOTELEPHONE

**hallicrafters RADIO**

THE HALLICRAFTERS CO., MANUFACTURERS OF RADIO AND ELECTRONIC EQUIPMENT, CHICAGO 16, U. S. A.  
 Sole Hallicrafters Representatives in Canada: Rogers Majestic Limited, Toronto-Montreal

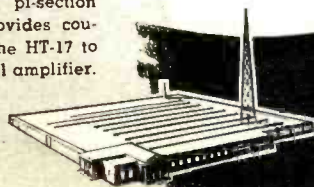

# Now...

New **BATTERY OPERATED**  
**RCA VOLTOHMYST**

## you can use it anywhere!

**Measures voltage  
resistance . . . and current**

**A**BOUT THE HANDIEST METER in the service field! In one instrument, for one price, you get an electronic voltmeter, ohmmeter, and ammeter . . . *battery-operated* to make it completely independent of power-line sources.

Use it to test car radios, farm sets, railroad signal equipment, aircraft radio, industrial electronic devices . . . opens up hundreds of profitable new opportunities beyond the limits of power lines.

With it you can measure both a-c and d-c voltages to 1000 volts, resistance to 1000 megohms, and direct current to 10 amperes. A new low-cost, RCA crystal probe can be attached if you want to make v-h-f measurements.

Most important, this instrument is easy on batteries. They last up to 10 months in normal service. A neon pilot light flashes when the instrument is on . . . serves as a reminder to turn the instrument off when not in use.

Linearity and stability are excellent.

Here is one of the best buys in test equipment on the market today. We'll be glad to send you complete descriptive and price information on this time and money saver. See it at your RCA Test Equipment Distributor.



**TEST AND MEASURING EQUIPMENT**  
**RADIO CORPORATION of AMERICA**  
**ENGINEERING PRODUCTS DEPARTMENT, CAMDEN, N. J.**

In Canada: RCA VICTOR Company Limited, Montreal

**I'll Send You 8 Big Kits of Training Equipment**  
*including*  
**TWO-BAND 6 TUBE SUPER RECEIVER**  
**AND 16 RANGE METER SET-UP**  
*for Testing*

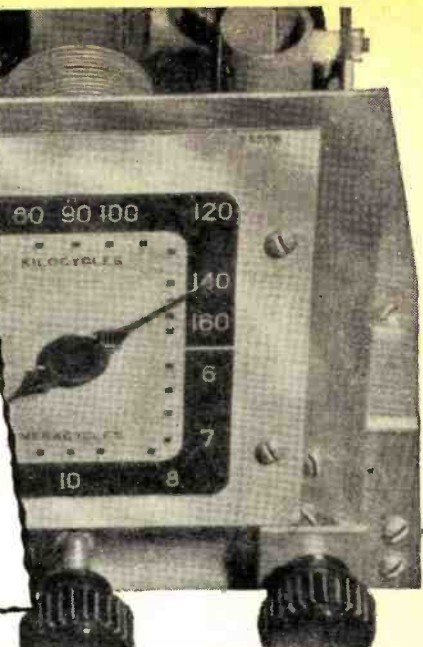

**Learn Fast... Earn Fast**  
**HOME TRAINING**  
**Planned For Your Needs**  
*You Build All These*  
**TESTERS... and MORE!**

I give you a fine, moving-coil type Meter Instrument on Jewel Bearings—with parts for a complete Analyzer Circuit Continuity Tester. You learn how to check and correct Receiver defects with professional speed and accuracy.

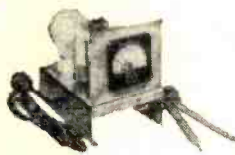

**Practice Does It!**  
 Soldering, wiring, connecting Radio Parts... building circuits with your own hands—you can't beat this method of learning. When you construct this Rectifier and Filter Resistor and Condenser Tester, etc., you get a really practical slant on Radio that leads to a money-making future.

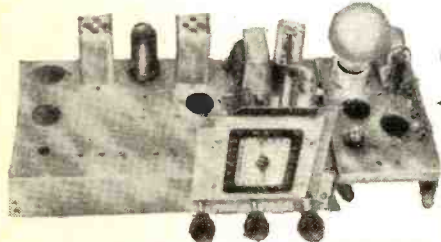
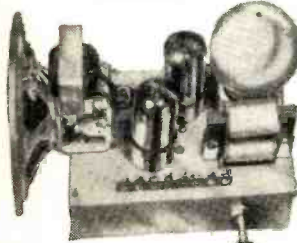

Building this Signal Generator and multi-purpose Tester will give you the kind of valuable experience and practice that is so important as a foundation for making good money in Radio. It makes a breeze out of fixing Radios, and you don't have to spend money on ready-made Equipment.

Read What Graduate Says: "One Job Nets About \$26.00!" "Since last week I fixed 7 radios, all good-paying jobs, and right now I am working on an amplifier system. This job alone will net me about \$26.00. As long as my work keeps coming in this way, I have only one word to say, and that is 'Thanks' to my Sprayberry training and I am not afraid to boast about it." ADRIEN BENJAMIN, North Grosvonordale, Conn.



**PRACTICE WITH YOUR OWN HANDS!**  
 Mind training through hand practice, that's the only way to LEARN and REMEMBER Radio. It's the most successful of Home Training methods.



**OVER 175 PRACTICAL EXPERIMENTS**  
 You'll find out how to build countless Radio Circuits. You'll learn a new, fast way to test Radio Sets without mfg. Equipment.

**LOW COST HOME RADIO TRAINING!**  
**Easy Monthly Payments!**

The answer to the PRACTICAL results, I show my Students lies in the way I train you. Not books and lessons alone. But "sight demonstrations" with real Radio Parts worked out with your own hands. You LEARN! You UNDERSTAND! You REMEMBER! Pay special attention to the quality and completeness of the Equipment which comes with the Sprayberry Course. You get a big 6 Tube Super Receiver and a 16 Range Meter Set-up for testing. When I put you to work with the 8 big Kits of Radio Parts I send you, you'll really LEARN Radio and learn it RIGHT! You'll get the practical experience

and pre-conditioning you need to be useful in Radio, and that's what it takes to make money. You don't need any previous experience. The Sprayberry Course starts right at the beginning of Radio—you can't get lost!  
 Soon after you begin your Sprayberry Course, I'll send you my sensational BUSINESS BUILDERS. You'll learn how to get and do neighborhood Radio repair jobs for nice profits and rich experience. With the kind of Training I give you, you will be able to set up your own Business, or step into a good-pay job in Radio, Television, FM, Radar, Industrial Electronics. Don't waste time! Make your start NOW!

**MAIL COUPON FOR THESE 2 BOOKS!**



"How to Read Radio Diagrams and Symbols" and "How to Make Money in Radio, Electronics and Television." Immense, practical value to you — and they're yours FREE!

**SPRAYBERRY ACADEMY OF RADIO**  
 F. L. Sprayberry, President  
 Room 2597 Pueblo, Colorado

Please rush my FREE copies of "How to MAKE MONEY in RADIO, ELECTRONICS and TELEVISION" and "How to READ RADIO DIAGRAMS and SYMBOLS."

Name \_\_\_\_\_ Age \_\_\_\_\_

Address \_\_\_\_\_

City \_\_\_\_\_ State \_\_\_\_\_

(Mail in envelope or paste on penny postcard)

# TRANSVISION

## TELEVISION KIT

**4 GOOD DOLLARS-AND-SENSE REASONS WHY**  
**The TRANSVISION TELEVISION KIT**  
**IS THE CHOICE OF DISTRIBUTORS, DEALERS**  
**AND THOUSANDS OF USERS!**



**BIGGEST VALUE**  
 LEADING "BUY" IN THE FIELD

**TOP QUALITY**  
 IN EVERY PART

**NEW SYNC. CIRCUIT**  
 GIVES STABLE PICTURE

**BACKED BY EXTENSIVE**  
**NATIONAL**  
**ADVERTISING**

• **BIGGEST VALUE:** When assembled the Transvision Kit becomes a television receiver worth more than twice its cost. The quality of performance has been acclaimed superior to other available sets by over 10,000 satisfied users.

The kit is **COMPLETE** with *sight and high fidelity sound reproduction*. Nothing more to buy. No technical knowledge required for assembly. Our complete easy-to-follow instruction sheet gives you all the knowledge you need. No test equipment needed. All difficult assemblies such as the R.F. Unit, I.F. Transformers, are factory wired pre-tuned. . . . . **NET \$159.50** (fair traded.)

• **TOP QUALITY PARTS:** You get a brilliant 7-inch, Electrovision Picture Tube, all other 17 tubes; pre-tuned R.F. Unit, tuned I.F. Transformers, 6" speaker, and all other necessary parts including a finished front panel, solder, hook-up wire, a **NEW SPECIALLY DESIGNED FOLDED DI-POLE ANTENNA** with 60 feet of low-loss lead in cable. The total value of all these parts would come to over \$300.00 list.

• **The pre-tuned R.F. UNIT** mentioned above is the heart of the television set. It is completely wired, pre-tuned, and tested by Transvision. Includes 6C4 oscillator and 6AC7 converter tubes. Designed for high conversion gain and 6mc bandwidth. Nothing for you to do but install.



• **NEW SYNC. CIRCUIT** achieves stable picture, sharp focus. Engineered by Transvision, it gives a maximum of picture stability even in areas of low signal strength or high noise levels. Clear enjoyable reception assured.



**BEAUTIFUL CABINET:** Transvision offers a beautifully-styled cabinet exclusively designed for their kit. Made of selected grain wood with attractive hand-rubbed walnut finish. An accessory kit is included for use in mounting the assembled Transvision set into the cabinet. Overall size 17 1/2" deep; 19 1/4" wide; 15 3/8" high. . . . . **NET \$29.95**

**IMMEDIATE DELIVERY:** The extensive engineering and manufacturing facilities of Transvision facilitate prompt shipment of all orders.

See your local distributor, or for further information write to:

**TRANSVISION, INC.**

Dept. R. N.

385 North Ave. New Rochelle, N. Y.

# For the RECORD.

BY THE EDITOR

**T**HE editors of RADIO NEWS have long been of the opinion that practical experience with television circuits is required by the thousands of capable and experienced radio service technicians who will soon be called upon to install and service the home television receivers which the radio manufacturers are producing in rapidly increasing volume.

The need for personnel familiar with practical television is increasing daily. In addition to the thousands of experienced technicians in demand by the home market, there is and will be a greater demand for capable technicians in television receiver factories. As industrial television hits its stride, a completely new field of electronic activity will offer splendid opportunities for the television technician and engineer.

In answer to this need for a means of television training, RADIO NEWS takes pride in presenting in this issue a television receiver construction-training project which has been sponsored by the editors. The circuits employed in this receiver are fundamental. The parts and components necessary to build it are, for the most part, standard, of high quality, and not expensive. The circuits are flexible so that the "experimentally minded" service technician can carry on from this unit to explore the many possible variations from the fundamental without undue signal deterioration. Using this fundamental video set, it is possible to later employ a larger picture tube, speaker, etc., at little additional cost.

Because of the complexity of television signals and their associated circuits, it is not practical to attempt to combine theoretical discussions in a construction article of this nature. Therefore, our presentation here presumes that the builder is sufficiently versed in the theory and practical aspects of television receiver design to enable him to complete the project from the comprehensive outline of constructional details contained in the article. We feel that you will be delighted with the results obtained from this initial project.

**D**UE to the desire of manufacturers to present adequate displays and demonstrations, the RMA has asked that the Radio Servicemen's Convention, previously scheduled to be held in Philadelphia in September 1947, be postponed until January 1948. If the January date is approved, the odds

are in favor of a highly successful convention.

**A**T THIS writing, Zenith's Phone Vision system, recently demonstrated in Chicago, hasn't aroused much interest outside of the novelty it afforded passers-by on Michigan Boulevard. Neither Zenith nor any telephone company has requested any frequency allocation from the FCC and we seriously doubt that telephone company officials are lying awake nights dreaming up plans for entering the show business.

**T**HE results of our recent field test using narrow-band FM for mobile communications were highly satisfactory. So much so, in fact, that we are now preparing a final version of the RADIO NEWS "Narrow-Band FM Mobile Transmitter." This unit is not much larger in physical size than an ordinary Brownie camera and is light enough to be easily held in one hand.

Experience has shown that the most satisfactory location for a NBFM amateur mobile rig is either in or near the glove compartment.

As a companion unit, we are also building a narrow-band FM receiver which will be approximately the same size as the transmitter.

The interest in FM mobile is definitely on the increase and we feel that the design of compact units will do much to foster further interest in this method of amateur communications.

**T**HERE has recently been an epidemic of "carrier current" broadcast stations put into operation. Most of this activity seems to be centered in southern Indiana. The latest case to be brought to our attention was a station in Columbus, Indiana, signing the call letters LQW and operating on 1150 kc. Programs were made up entirely of recordings and time was sold to the local merchants.

After a short period of operation, the FCC closed down the station for exceeding the maximum allowable field strength and interfering with legitimate broadcast stations. The station was clearly heard on auto radios in several parts of the town.

With the FCC limitations on radiated power, it is practically impossible to operate a station of this type in a legal manner. In the absence of accurate field strength measuring equipment, stay clear of this type of operation and avoid a possible fine and jail sentence. . . . . O.R.



# There's Only One Complete Radio Buying Guide!

It's **ALLIED'S 164-PAGE RADIO CATALOG** — *Get It!*

**FREE**



## Everything in Radio at Lowest Prices!

Get your copy of this big COMPLETE book NOW! It shows everything you need and want in radio and electronic equipment—over 10,000 items—and all at real money-saving prices. You'll find new, ultra-modern radios, phonos, recorders—high quality test equipment of all types—complete PA and Sound Equipment—new, powerful Communications

Receivers—plus thousands of parts, tubes, tools, books, diagrams, kits . . . everything for the experimenter, builder, serviceman, ham and short-wave listener. Send today for your copy of Radio's biggest and best Buying Guide. Make ALLIED your Radio Headquarters—it's the established, dependable supply source for America's radio men.

## ALLIED IS FIRST With These New Communications Receivers!



**HALLICRAFTERS S-47**

New FM-AM receiver. AM reception 535-1720 Kc. and 5.9-18.2 Mc.; FM reception 88-108 Mc. 14 tubes plus rectifier. Bandsread from 9-12 Mc. and 15-18 Mc. Calibrated slide-rule dials; dual tone controls. 500 ohm output. Phono input socket; push-button channel selection; response essentially flat from 30-7500 cps AM; 30-15,000 cps FM. 110 v. AC. 12 watts power output. In cabinet, **NET. \$200.00**  
Chassis only, **NET. \$189.50**



**NATIONAL HRO-7**

Newest model in the world-famous, dependable HRO line—a remarkable performer under any receiving conditions. Features modern styling, voltage regulated 6C4 oscillator, double-action type variable noise limiter, tone control, accessory power take-off, separate power supply for 110-220 v. AC operation. Complete with tubes and power supply. **NET \$299.36**



**HALLICRAFTERS SX-43**

The new SX-43 gives you more value—greater performance, broader frequency coverage (550 Kc. to 55 Mc. and 88-108 Mc.)—a fine investment in the medium price range. AM-FM-CW reception, Crystal filter, calibrated main and bandsread dials, variable tone control, precision engineered for custom-built performance! This is a real, big-league, all-around Communications Receiver for Ham or Short Wave Listener. **NET. \$169.50**

### Other Communications Receivers

National NC-173 & Spkr. \$189.50	Hammarlund HQ-129X & Speaker. . . . . \$173.25
National NC-2-40D. . . . . 225.00	RME-84. . . . . 98.70
National NC-46 & Spkr. . . . . 107.40	RME-45 & Speaker. . . . . 198.70
Hallicrafters SX-42. . . . . 275.00	RME VHF-152 Converter. . . . . 86.60
Hallicrafters S-38. . . . . 47.50	RME DB-22 Preselector. . . . . 60.00
Hallicrafters S-40A. . . . . 89.50	
Hammarlund SPC-400X & Speaker. . . . . 347.25	

Net FOB Chicago. Prices subject to change without notice

### TIME PAYMENTS Trade-Ins Accepted

#### RADIO'S LEADING BUYING GUIDE

**FREE**

ALLIED RADIO CORP.  
833 W. Jackson Blvd., Dept. 1-JJ-7  
Chicago 7, Illinois

- Send FREE 164-Page ALLIED CATALOG
- Enter order for.....
- Enclosed \$.....  Full Payment
- Part Payment (Balance C.O.D.)

Send full information on Communications Receivers and Time Payment Plan, without obligation.

Name.....

Address.....

City..... Zone..... State.....

**ALLIED RADIO**  
Everything in Radio and Electronics

September, 1947

# NEVER BEFORE

Compare Centralab Ceramic BC "Hi-Kaps"			ADVANTAGES
"HI-KAP" FEATURES	DESCRIPTION		
1. Impervious to moisture	Ceramic-X is non-hygroscopic. Moisture absorption is .007% or less.		No deterioration, no shorting. Longer life even under the most adverse conditions.
2. Low mass weight	Av. Wt.	Dimensions	For unit size and weight, Centralab BC "Hi-Kaps", made with Ceramic-X, are the only capacitors on the market which provide these voltage ratings.
3. Small size	Values		
4. High capacity	.029 oz.	D—.315" L—.540"	
	.044 oz.	D—.315" L—.830"	
	.050 oz.	D—.340" L—1"	
	.082 oz.	D—.400" L—1.305"	
5. Special insulation	Wax impregnated, lacquered, dipped in special phenolic resin, cured and wax impregnated.		Prevents any possibility of shorting to adjacent leads, chassis or components.
6. Convenient side leads	Heavy #22 gauge tinned copper.		Permit rapid, close-coupled connections. No tricky bending or fitting required.
7. Low power factor	Initial—.6%. After 100 hours, 95% humidity test—3.0%.		More efficient circuit operation, fewer failures.
8. High leakage resistance	Initial—5000 megohms. After humidity—500 megohms.		Long life, more efficient performance.
9. Maximum dependability	One-piece construction. Leads soldered directly to electrodes.		Will not short or become intermittent.
10. Factory tested	For your protection, all units 100% factory tested before packaging and shipping.		Your guarantee to your customers of reliable service and performance.



**See for yourself—five "Hi-Kaps" neatly packaged in convenient envelope. Clean, easy to stock, easy to handle!**

Here's modern merchandising at its best! Centralab now gives you ceramic capacitors at a new low price . . . sealed in handy envelopes that save you time and effort. Each package contains five ceramic capacitors of the same value, quickly identifiable by tab at top. All capacitors individually color coded, inspected and insulated!

has the dependability, permanence and convenience of ceramic by-pass and coupling capacitors been offered to radio service dealers at a favorable price!

 See for yourself why **Centralab Ceramic BC "Hi-Kap" Capacitors, feature for feature, are your best buy for QUALITY . . . your best buy for PRICE!**

TODAY'S TREND is toward ceramic capacitors! Yes, more and more manufacturers are turning to them for longer life and better set performance. And now, Centralab offers you this opportunity to give yourself and your service customers the newest and finest in capacitor components.

Made with high dielectric constant Ceramic-X, BC "Hi-Kaps" are by-pass and coupling capacitors, rated at 600 WVDC—1000 V. flash tested. Values from .000050 to .010000 mfd, list priced from \$1.25 to \$1.50 *per envelope of five* (see opposite page). Now available at your Centralab Distributor! Look for large counter display, or individual display, shown at right.



**FREE!** Write today for this valuable addition to your technical library. "Why Ceramic Capacitors" is an important new booklet containing a complete history of the origin and development of ceramic capacitors.

See your Centralab Distributor for complete information on this new line of ceramic by-pass and coupling capacitors, or write direct to . . .

**Centralab**  
Division of GLOBE-UNION INC., Milwaukee

# DAVEGA Communications Division ★★★

68 YEARS OF DEPENDABLE SERVICE TO THE PUBLIC

**Just Arrived**

## THE NEW NATIONAL HRO-7

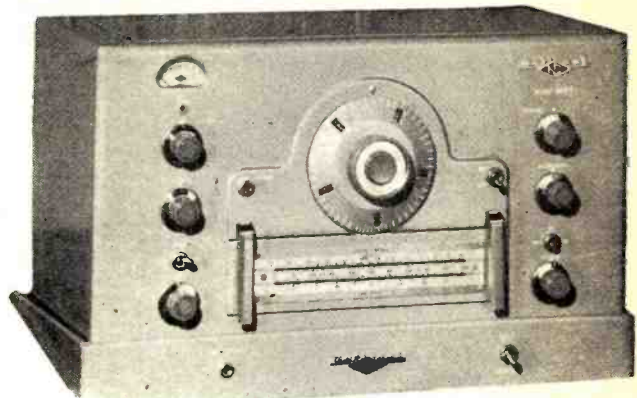

MAIL COUPON FOR  
DESCRIPTIVE LITERATURE

Here are some of the many new features in this outstanding performer. New automatic, adjustable threshold, double action noise limiter. Two new miniature type tubes, a 6C4 high-frequency oscillator and an OA-2 voltage regulator are employed to give a high order of oscillator stability. Eleven tubes plus voltage regulator. Normally supplied with coils for 1.7 MC to 30 MC.

RECEIVER ..... \$279.00  
SPEAKER ..... 12.00  
POWER SUPPLY .. 20.36

## THE NEW NATIONAL NC-173

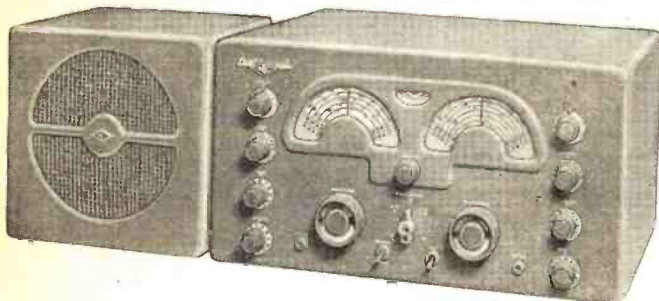

This set has been sweeping the country by storm since its recent introduction to Hams. Newest in radio technic and exceptional in frequency scope, 0.54 to 31 MC and 48 to 56 MC. **\$179<sup>50</sup>**  
Speaker \$10.00 additional.

## THE NATIONAL NC-46



The National NC-46 has 4 bands, electrical band-spread, 10 tubes, push-pull output. Frequency coverage 0.540 to 30.0 MC. AC-DC. **\$107<sup>40</sup>**  
Complete with loud speaker.

# DAVEGA Stores

**NEW YORK**  
Downtown...63 Cortlandt Street  
Hotel Commodore...111 E. 42d St.  
Times Square...152 W. 42d St.

**NEW JERSEY**  
Newark.....60 Park Place  
Jersey City...30 Journal Square  
Paterson.....185 Main Street

**WESTCHESTER**  
White Plains...175 Main Street

**LONG ISLAND**  
Jamaica...163-24 Jamaica Avenue  
Flushing.....39-11 Main Street  
Hempstead.....45 Main Street

DAVEGA COMMUNICATIONS DIVISION  
63 Cortlandt Street New York 7, N. Y.  
Please send full information on Communications Receivers.  
 Enter order for .....  
 Send full information on Communications Receivers,  
without obligation.  
Name .....  
Address .....  
City.....Zone.....State.....  
RN-5

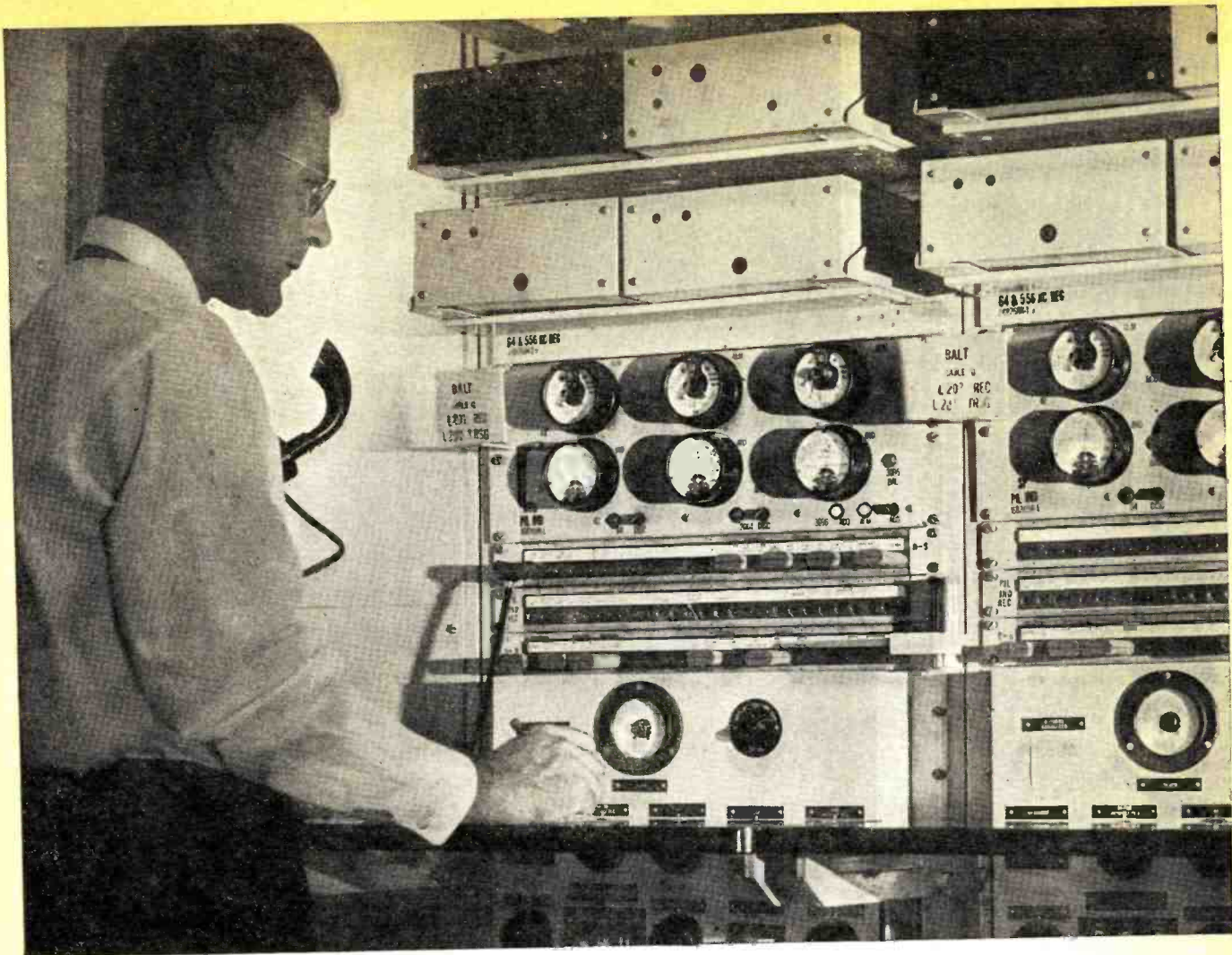

At Philadelphia, a testboard man answers as an electronic watchman calls attention to conditions on one of the coaxial systems to Baltimore and Washington.

## “Send Help to Manhole 83”

Strung out along every Bell System coaxial cable, electronic watchmen constantly mount guard over your voice. Some are in manholes under city streets; some are in little huts on the desert. Most situations they can deal with; if things threaten to get out of hand, they signal the nearest testboard.

Principal care of the electronic watchman is the transmission level. Sun-warmed cables use up more energy than cold ones, so a transcontinental call may take a millionfold more energy to carry it by day than by night.

Each watchman — an electronic regulator — checks the transmission level and adjusts the amplification which sends your voice along to the next point. Many hundreds of regulators may be at work on a single long distance call.

Without automatic regulation, the precise control of energy in the Bell System's long distance circuits would be a superhuman task. So Bell Laboratories, which in 1913 developed the first high vacuum electronic amplifier, went on to devise the means to make them

self-regulating in telephone systems. This is one reason why your long distance call goes through clearly, summer or winter.

### BELL TELEPHONE LABORATORIES

Exploring and inventing, devising and perfecting for continued improvements and economies in telephone service.



# IMPORTANT ANNOUNCEMENT to my Servicemen friends:

In just one year, PHOTOFACT has become the leading Radio Data Service. I owe this success to you. Your support has made it possible for the SAMS organization to provide you with the most complete, accurate and uniform service information ever published. Your backing has encouraged us to extend our activities. As part of our continuous program in behalf of the Servicing profession, I am happy to announce two important new publications. Like PHOTOFACT Folders, they meet a real need—you've told us so. And like PHOTOFACT, these new publications are based on our own actual study of the equipment covered. I am confident these new books will help your business . . . To each and every one of you I say a heartfelt "Thanks!"

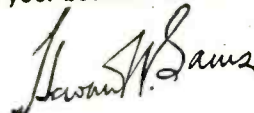

## NEW! HOWARD W. SAMS DIAL CORD STRINGING GUIDE

Only Book of its Kind!



ONLY  
**75¢**

Handy pocket size  
Over 96 pages

Easy to read  
diagrams and data

There's only one *right* way to string a dial cord. And there's only one book that shows you how. It's the Howard W. Sams DIAL CORD STRINGING GUIDE. Here, for the first time, in one pocket-sized book, are complete dial cord diagrams and data covering 1938 through 1946 receivers. Actually, there are many ways you can go about stringing a dial cord—but only one is *right*. You know from your own experience that if you get started the wrong way, you can waste hours of your valuable time and work yourself into a nervous lather. You can say "goodbye" to wasted time when you have a SAMS DIAL CORD STRINGING GUIDE. It licks the knottiest dial cord problem in a matter of minutes. This low-cost book is a "must" for servicing. You'll want two copies—one for your tool kit and one for your shop bench.

**ORDER YOUR COPIES TODAY!**

## NEW! HOWARD W. SAMS 1947 AUTOMATIC RECORD CHANGER MANUAL

There's Nothing Like It!

COVERS MORE THAN 40 DIFFERENT POST-WAR MODELS! A DeLuxe volume, packed with ORIGINAL data based on actual study of the equipment covered. Absolutely accurate, complete, authoritative. No other information like it available: Shows exclusive "exploded" views; photos of top, side, bottom and rear views. Tells you manufacturers who use the equipment. Gives full change-cycle data. Complete information on all adjustments. Invaluable Service hints and kinks. Shows complete parts lists keyed to diagrams and photos. Uniform treatment for each piece of equipment. PLUS—for the first time in any publication—complete, accurate service data on leading WIRE, TAPE, AND DISC RECORDERS! No modern service shop can afford to be without this book!

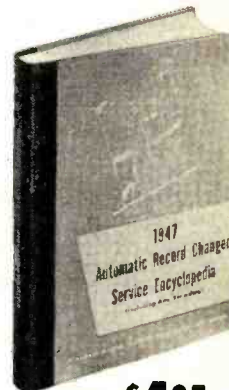

ONLY **\$4.95**

416 pages • Hard Cover  
Smythe-sewed—opens flat  
Hundreds of photographs  
and diagrams

**ORDER YOUR COPY TODAY!**

## New Aids Make PHOTOFACT FOLDERS More Useful Than Ever!



They're yours for the asking: **PHOTOFACT CUMULATIVE INDEX**—Complete Index to first 20 Sets of PHOTOFACT Folders; your guide to more than 1800 receiver models and chassis (1946 and 1947 models). **HOW TO FILE FOLDER**—shows 5 good ways to file PHOTOFACT Folders, including new "30-Second" filing method. Ask your parts jobber for FREE copies of these PHOTOFACT aids, or write us direct.



SETS NO. 22 AND NO. 23 } 160 pages of valuable, needed data covering  
NOW AVAILABLE! } current models. Same low price of \$1.50 per set.

HOWARD W. SAMS & CO., INC.  
INDIANAPOLIS 6, INDIANA

Export—Ad. Auriema—89 Broad St., New York 4, N. Y.—U. S. of America  
Canada—A. C. Simmonds & Sons, 301 King St., East—Toronto, Ontario

# PHOTOFACT SERVICE

"The Service that pays for itself over and over again"

MAIL THIS ORDER FORM TO YOUR PARTS JOBBER TODAY—or send directly to HOWARD W. SAMS & CO., Inc., 2924 E. Washington St., Indianapolis 6, Ind.

My (check) (money order) for \$..... enclosed.

- Send..... SAMS' DIAL CORD STRINGING GUIDE(S), at \$0.75 per copy.
- Send..... SAMS' 1947 AUTOMATIC RECORD CHANGER MANUAL(S), at \$4.95 per copy.
- Send PHOTOFACT Set No. 22 (at \$1.50).
- Send PHOTOFACT Set No. 23 (at \$1.50).
- Send PHOTOFACT Volume No. 1 (including Sets Nos. 1 through 10) with DeLuxe Binder, \$18.39.
- Send PHOTOFACT Volume No. 2 (including Sets Nos. 11 through 20) with DeLuxe Binder, \$18.39.
- Send FREE Cumulative Index.
- Send FREE "How to File" Folder.

Name .....

Address .....

City..... State.....



### CHECK THESE OUTSTANDING FEATURES

Frequency response of Tuners is flat within  $\pm 2$  db from 30 to 15,000 cycles! Bass control provides 10 db boost at 40 cycles; treble control varies response from +12 db to -14 db at 10,000 cycles. Volume control has automatic bass compensation circuit to match the bass characteristic of the human ear.

Sensitivity of the Tuners is less than 10 microvolts. Selectivity for AM signals may be made either "broad" or "sharp". Output of the Tuners is 8 volts at the high-impedance terminals and .75 volts at the 500 ohm terminals. Hum level is 60 db below output. Phonograph input terminals are provided so that Tuner and its amplifier may be used with a record player. Any antenna with single lead-in wire can be used for AM signals. FM section designed for an antenna having a balanced 300 ohm transmission line.

AM-FM Tuner Tube complement; 9003 R. F. Amplifier; 6BE6 oscillator converter; 2-9003 I. F. Amplifiers; (456 kc); 6AL5 detector for AM section. For the FM section; 6AG5 R. F. Amplifier; 6C4 oscillator; 6AG5 converter; 3-6AG5 I. F. Amplifiers (10.7 mc.) 2-9001 limiters and 6AL5 detector. Two 6C4's are used for audio amplifiers, a 6U5/6G5 for tuning indicator and 5Y3GT/G for rectifier.

AM Tuner Tube complement; 6BA6; 6BE6; 2-6BA6; 6AL5; 2-6C4; 5Y3GT/G and 6U5/6G5.

available now  
**MEISSNER**  
AM and AM-FM TUNERS

For  
*Superlative Reception*

Designed for use wherever exceptionally high fidelity reception is desired, the new postwar Meissner AM and AM-FM Tuners are now available for your most exacting requirements. Both of these new precision designed components cover the broadcast band from 527 to 1620 kc. and the AM-FM Tuner also covers the FM band from 88 to 108 mc. At 105-125 volts, 50-60 cycles, power consumption is 80 watts for the AM-FM Tuner and 60 watts for the AM Tuner. See these quality units at your jobbers today or write for complete specifications to the address below;

*Meissner*

**ELECTRONIC DISTRIBUTOR AND  
INDUSTRIAL SALES DEPARTMENT  
MAGUIRE INDUSTRIES, INC.  
936 N. MICHIGAN AVE., CHICAGO 11, ILLINOIS**

EXPORT ADDRESS: SCHEEL INTERNATIONAL  
4237 N. LINCOLN AVE., CHICAGO 18, ILL. CABLE—HARSHEEL

The **LITTLE** differences

make the

**BIG**

**DIFFERENCE**

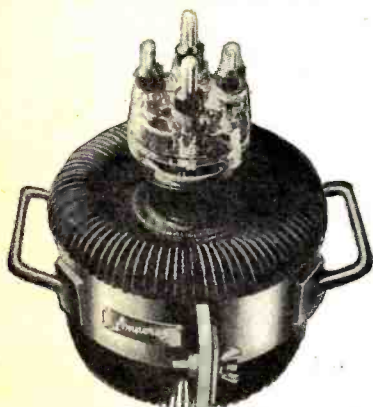
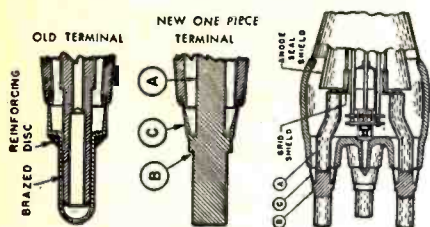

Though all transmitting tubes may look alike, the little "extras" are the things that distinguish Amperex tubes. For example, one of these "differences" is the one-piece contact pin and grid and filament support used in the Amperex 889R-A. Made of pure, oxygen-free, non-magnetic copper, this support is a complete unit by itself.

This new Amperex structure is stronger... **much stronger!** Where the old pins could be distorted by side pressure, the new ones resist that pressure up to the breaking point of the glass.

In addition, the one-piece design has enabled us to relocate and redesign the anode and grid shields, thus reducing glass heating and resultant punctures. It will pay you well to...

**Re-tube With Amperex**

**AMPEREX ELECTRONIC CORP.**

25 WASHINGTON STREET, BROOKLYN 1, N. Y.

In Canada and Newfoundland: Rogers Majestic Limited  
11-19 Brentcliffe Road, Leaside, Toronto, Ontario, Canada

16

## Spot Radio News

★ Presenting latest information on the Radio Industry.

By **FRED HAMLIN**

Washington Editor, RADIO NEWS

**WHATEVER** else may be said (and it will be plenty), you can bank on one thing concerning Maine Senator Wallace H. White Junior's bill proposing changes in the Federal Communications Commission; everything including the kitchen sink will be used to beat the proposed legislation to a pulp. After the recent hearings, indeed, the impression was that nobody loves the bill except the Senator from Maine, and it is even possible that he has cast a few dubious (though secret) glances at his brain child following the hornet's nest of protests that it brought swarming round his head. Something else to pin in your hat: While the Senator's proposals caused the loudest explosion in the FCC-broadcasting field, final outcome of the bill will influence all FCC activities, perhaps beneficially. And another thing—despite the Senator's optimistic declarations that he hopes for quick passage, indications, as this goes to press, are that the bill or whatever is hammered out to replace it will remain in radio news headlines for some time to come.

**THE BILL IN QUESTION**, in case you haven't had the time to go through the volumes of testimony concerning it, proposes that FCC be divided into two sections so that some of its commissioners may concentrate on broadcasting problems while others devote most of their time to other FCC headaches. If the broadcasting experts encounter difficulties fit to blow their heads off, they will be able to seek an aspirin of advice from the other commissioners, and vice versa. But, generally, they will concentrate on their special and assigned fields. So far, so good. But the bill goes on to propose limiting the number of FCC broadcasting franchises economically. If somebody wants to start a station and FCC decides he can't make dough at it, off with his head! Philosophically, in other words, the Senator regards radio not as a vehicle, to transport free speech, but as a common carrier, like a bus. Other provisions of the proposed bill carry out this philosophy in some detail.

**PROTESTS** to the White bill brought out a galaxy of radio talent. Charles Denny, FCC chairman, speaking for the whole Commission, testified that he believed that FCC's work-load

should be divided into three, instead of two, compartments, composed of four members each. These would be a Broadcasting Division, a Common Carrier Division, and a Safety and Special Services Division. The chairman would serve on all divisions and in case of a tie the entire Commission would review the moot question. Denny also protested the common carrier idea so far as broadcasting stations are concerned, as well as a number of the details with which Senator White proposed to enforce it. Regardless of his protests, it is worth recording that he and the Senator got along pretty well and both questions and answers were friendly.

**NOT SO WHEN THE WITNESSES** for the National Association of Broadcasters, led by Justin Miller, NAB president, took the stand. President Miller promptly began to reiterate a theme which he has been expounding for some time. Freedom of radio, he stated, is as sacred as freedom of the press. Any move to hamper that freedom—and the White bill moved against it in a big way—was unconstitutional and a threat to the democracy. Miller, who has never been too sanguine about the present law outlining FCC's powers, said that even it was preferable to the White bill. The Senator promptly came back with charges of "sanctimoniousness," "picayunish quibbling" and "raving and ranting." He even went so far as to say that "all this talk about freedom is talk about something that doesn't exist." Through long sessions, he and his committee and Justin Miller and others from NAM battled angrily. They finally seemed to agree on one thing—that NAB should submit recommendations as to how the bill might be revised. But if Miller's testimony and the White reactions are any indication, such recommendations will only add fuel to the flames.

**OUTCOME OF** the controversy will probably not, as has been indicated, be as prompt and decisive as Senator White desires. Possibility at writing is that the over-all problem would still be a hot potato when the Congress convenes in 1948. But at least the White bill has already accomplished a couple of things. The NAB-FCC freedom-of-the-air battle at last is in the open. And FCC, regardless of

**RADIO NEWS**



# 2 METHODS

# Learn RADIO-ELECTRONICS

at HOME... or in our LABORATORIES

## TAKE YOUR CHOICE!

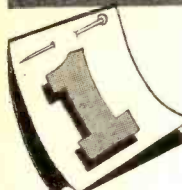

**LEARN IN CHICAGO IN ONE OF NATION'S FINEST TRAINING LABORATORIES**

36 weeks — that's all the time you need to get one of today's finest practical trainings in RADIO and ELECTRONICS. That's all the time required to prepare yourself for America's great opportunity field that offers so many thrilling possibilities for a GOOD JOB with a REAL FUTURE — or a profitable RADIO SERVICE BUSINESS OF YOUR OWN.



MODERN TELEVISION TRAINING calls for ample equipment. In our modern Chicago training laboratories, you will find some of the finest Television equipment available for training purposes.

Now you can enjoy outstanding training advantages in the large, entirely NEW postwar laboratories of DeForest's Training, Inc. in Chicago. You get ALL of your instruction amid a large staff of highly skilled instructors and loads of modern, costly commercial Radio-Electronic and Television equipment.

We secure comfortable living quarters for you. Get complete facts about this remarkably effective way to qualify yourself QUICKLY for a GOOD PAYING FUTURE — and about our EMPLOYMENT SERVICE that helps our graduates GET STARTED. MAIL COUPON BELOW FOR COMPLETE DETAILS.

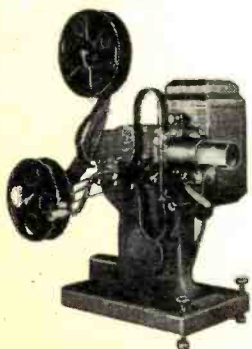

D.T.I.'s Home Study Course Includes the use of a 16 mm. Motion Picture projector and Movie Film to help you learn important fundamentals FAST-ER... EASIER. Get vivid — LASTING Impressions by means of the modern MOVIE-WAY method of instruction.



**GET "SHOP METHOD" TRAINING AT HOME — IN YOUR SPARE TIME**

Look around you! What other field embraces so many exciting, fast-moving activities as F. M. Radio, 2-Way Train Radio, Aviation Radio, Broadcast Radio, Radio Manufacturing, 2-Way Bus, Truck and Cab Radio, Police Radio and other branches?

DeForest's Training, Inc. makes it possible for YOU to train in the privacy of your own home for this bright field of Radio and Electronics — and without interling with your present job.

You get a long-tested, PROVED combination of home study advantages — plus EMPLOYMENT SERVICE — which helps you get started toward a real future in Radio and Electronics.

### 3-Way Method Gets Results!

No previous RADIO or ELECTRONIC experience is necessary. Our effective A-B-C Home Study Method includes (A) "Learn-By-Doing" Home Laboratory of many Radio parts enabling you to work out 133 fascinating experiments at home, including 7 different Radio Receiving Circuits; (B) a 16 mm. Movie Projector and 12 reels of "Learn-By-Seeing" Movie Film that speed your progress; and (C) well-illustrated lessons. MAIL COUPON BELOW FOR COMPLETE DETAILS.

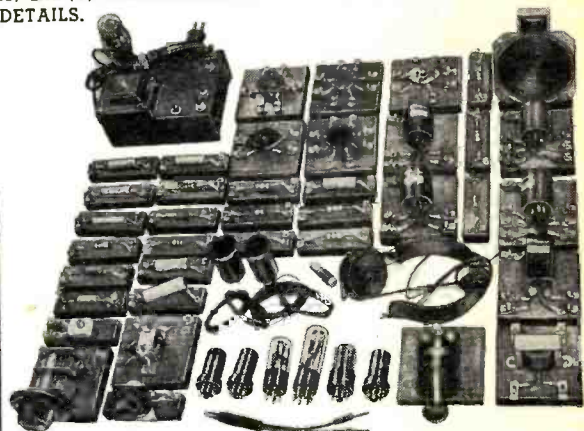

ABOVE: You work out 133 intriguing experiments from this equipment to get valuable, practical experience AT HOME.

### VETERANS!

Both our (1) Chicago Laboratory and (2) Home Study Courses are accepted under the "G. I. Law." If you qualify, the Government will pay cost of either Course you select.

## DEFOREST'S

TRAINING, INC.

Affiliated with the DeVRY CORPORATION  
CHICAGO, ILL.

E. B. DeVry, President  
DeForest's Training, Inc.  
2533 N. Ashland Ave., Dept. RN-D9  
Chicago 14, Ill.

Please send me information about the Radio-Electronic Course I have checked:

HOME STUDY       CHICAGO LABORATORY       BOTH

Name ..... Age.....

Address ..... Apt.....

City ..... Zone ..... State .....

If under 16, check here for special information.       If a discharged Veteran of World War II, check here.



"A device for transferring energy in an A.C. current from one circuit to another." But what characteristics must be provided before the transformer fulfills your needs! Include Merit **QUALITY!**

**EXPORT DEPARTMENT:**  
1607 Howard Street, CHICAGO 26, U. S. A.  
Cable Address: MERIT



**MERIT COIL & TRANSFORMER CORP.**

TELEPHONE  
4427 North Clark St. Long Beach 6311 CHICAGO 40, ILL.

**SPOT RADIO NEWS**

the White recommendations, will undoubtedly move more rapidly toward reorganization and streamlining. This may even result without legislation, at least to a degree. If the White proposal also eventually results in a "Magna Charta" of radio broadcasting, as some optimists hope, it will be a long time getting rewritten. If the industry is an indication, any resemblance to the present White bill will be purely coincidental.

**EVEN FARTHER** in the future, if our pipelines do not misinform us, is the pay-as-you-see television idea that President Eugene F. McDonald Jr. of the *Zenith Radio Corp.* proposed during the summer. The McDonald plan would make it possible for television owners to pay only for the program they desire to hear. An owner would call the television operator by phone, order a program, be billed for it by the phone people, and be able to tune it in with the aid of a small attachment on his telephone, which would transmit the missing key frequency to his set. No reaction to the idea could be had from FCC, but it might be in order to point out that the McDonald idea is not unlike one FCC thumbed down some time back. It was proposed to have a "pig-squeal" radio on which you could not get a program without screaming interference unless you paid for it. FCC said no—it would restrict radio's use to persons with extra cash and therefore was not in the best interests of the general public. Another thing that stands in the way of the *Zenith* attachment is that, so far as FCC is concerned, it is still in an experimental stage. It would have to get an experimental permit first, followed by hearings at which, if present trends are an indication, scores of protesters would appear to point out that *Zenith* wanted to use up too much of the spectrum. At best, such hearings would take a lot of time. To climax our little research project on the McDonald idea, we discovered as this went to press that *Zenith* has applied for neither an experimental license or a hearing. That puts them months, if not a year, away from an FCC decision, if any.

**THE McDONALD** proposal served one purpose—again to highlight television's difficulties in the program department. Programs are costly. A television season pass to a big-league ball park costs around \$10,000 and McDonald estimates that a hook-up program comparable to a top-flight AM radio show would cost as much as ten million annually. By contrast, television does not reach mass audiences and advertisers are therefore not willing to spend folding money. It follows that television programs generally have been of poor quality and that there hasn't seemed to be much anybody could do about it. A new departure in the field in Washington recently may point the way to some improvements, however. John Gaunt,

**RADIO NEWS**

**MONEY BACK GUARANTEE** We believe units offered for sale by mail order should be sold only on a "Money-Back-If-Not-Satisfied" basis. We carefully check the design calibration and value of all items advertised by us and unhesitatingly offer all merchandise subject to a return for credit or refund. You, the customer, are the sole judge as to value of the item or items you have purchased.

## The New KT-30 CHANNEL ANALYZER

*The Ultimate in Signal Tracing Includes . . .*

**METER**—For direct reading of signal intensity  
**SPEAKER**—For listening to the signal  
**PHONE**—For checking distortion and listening to the signal in low-gain channels

Comparative signal intensities indicated directly on the meter as Probe follows the signal. A special 4 1/2" P.M. speaker with oversize Alnico V magnet is used for quality checks. Many previously designed Signal Tracers were unable to measure and check low signal intensities. This disadvantage has now been overcome for the Model KT-30 incorporates a special circuit which permits the meter to be put across the output of the Signal Tracer. To accomplish this it is necessary only to flip a front panel switch. This results in additional gain and sensitivity permitting measurement of low signal intensities. An earphone provided with the unit permits listening to the signal in low-gain channels. Incidentally, insertion of the phone automatically cuts out the speaker.

**\$29<sup>95</sup>**  
NET

Complete with detector probe, test leads, self-contained batteries and earphone. Heavy-gauge crystalline cabinet.



## The New Model 650-A A.C. Operated SIGNAL GENERATOR

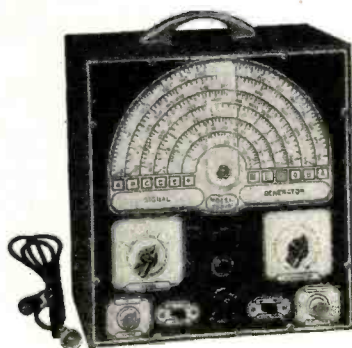

- Operates on 110-120 Volts 50 to 60 Cycles A.C.
- R.F. Frequencies from 100 Kc. to 35 Mc. on Fundamentals in 5 bands by front panel switch manipulation. One additional band provides Harmonics from 30 to 105 Mc.
- Audio Modulating Frequency—400 Cycles Pure Sine Wave. Distortion less than 2%.
- Attenuation: Features a newly designed 3-step ladder type of attenuator (T pad). The first step provides lowest output and can be multiplied by 10 and by 100 by turning the multiplier switch.

• Hartley Excited Oscillator Electron coupled to a Buffer Amplifier. Frequency stability is assured by modulating the amplifier stage.

Complete with coaxial cable, test leads and instructions. **\$39<sup>95</sup>**  
NET  
Heavy gauge grey crystalline cabinet with beautiful two-tone etched front panel. Size 9 1/2" x 10" x 6."

## The New Model CA-11 SIGNAL TRACER

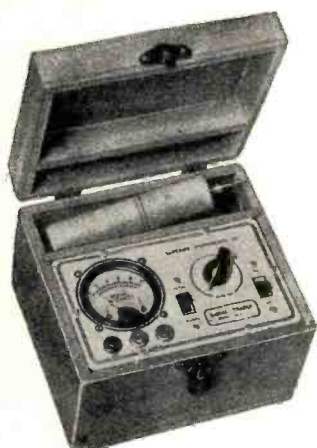

**SIMPLE TO OPERATE . . .**  
**BECAUSE SIGNAL INTENSITY READINGS ARE INDICATED DIRECTLY ON THE METER!**

- ★ SIMPLE TO OPERATE — only 1 connecting cable—NO TUNING CONTROLS.
- ★ HIGHLY SENSITIVE — uses an improved Vacuum Tube Voltmeter circuit.
- ★ Tube and resistor-capacity network are built into the Detector Probe.
- ★ COMPLETELY PORTABLE — weighs 5 lbs. and measures 5" x 6" x 7".
- ★ Comparative Signal Intensity readings are indicated

directly on the meter as the Detector Probe is moved to follow the Signal from Antenna to Speaker.

★ Provision is made for insertion of phones.

THE MODEL CA-11 COMES HOUSED IN A BEAUTIFUL HAND-RUBBED WOODEN CABINET. COMPLETE WITH PROBE, TEST LEADS AND INSTRUCTIONS.

**\$18<sup>75</sup>**  
NET

## The New Model 670 SUPER METER

A Combination  
**VOLT-OHM-MILLIAMMETER plus**  
**CAPACITY REACTANCE,**  
**INDUCTANCE and**  
**DECIBEL MEASUREMENTS**

D.C. VOLTS: 0 to 7.5/15/75/150/750/1500/7500. A.C. VOLTS: 0 to 15/30/150/300/1500/3000 Volts. OUTPUT VOLTS: 0 to 15/30/150/300/1500/3000. D.C. CURRENT: 0 to 1.5/15/150 Ma.; 0 to 1.5 Amps. RESISTANCE: 0 to 500/100,000 ohms, 0 to 10 Megohms. CAPACITY: .001 to .2 Mfd., .1 to 4 Mfd. (Quality test for electrolytics). REACTANCE: 700 to 27,000 Ohms; 13,000 Ohms to 3 Megohms.

INDUCTANCE: 1.75 to 70 Henries; 35 to 8,000 Henries.  
 DECIBELS: -10 to +18, +10 to +38, +30 to +58.

THE MODEL 670 COMES HOUSED IN A RUGGED, CRACKLE-FINISHED STEEL CABINET COMPLETE WITH TEST LEADS AND OPERATING INSTRUCTIONS. SIZE 5 1/2" x 7 1/2" x 3". **\$28<sup>40</sup>**  
NET



## The New Model 450 TUBE TESTER

**Speedy operation—assured by the newly designed rotary selector switch which replaces the usual snap, toggle, or lever action switches.**

### SPECIFICATIONS

- Tests all tubes up to 117 volts.
- Tests shorts and leakages up to 3 Megohms in all tubes.
- Tests both plates in rectifiers.
- New type line voltage adjuster.
- Tests individual sections such as diodes, triodes, pentodes, etc., in multi-purpose tubes
- Noise Test detects microphonic tubes or noise due to faulty elements and loose internal connections.
- Uses a 4 1/2" square rugged meter.
- Works on 90 to 125 volts 60 cycles A.C.

EXTRA SERVICE—May be used as an extremely sensitive condenser Leakage Checker. A relaxation type oscillator incorporated in this model will detect leakages even when the frequency is one per minute.

**\$39<sup>50</sup>**  
NET



**GENERAL ELECTRONIC DISTRIBUTING CO.** Dept. RN-9, 98 Park Place  
 NEW YORK 7, N. Y.



# FREQUENCY CALIBRATOR

CAT. NO. FCC-90



Measures only 2 1/4" by 4 1/4"

● Now you never have to take the chance of getting a pink ticket for off-frequency operation . . . BUD makes it easy for you to know your exact frequency. The new BUD Frequency Calibrator is easy to use, is entirely self-powered and has these exclusive features:

It is not necessary to open up or take apart your receiver to wire-in this unit . . . just plug in to 110 volt line and connect output lead to antenna post of your receiver.

Has 100 Kilocycle crystal, rich in harmonics.

Has compensating condenser to zero beat WWV.

Has usable harmonics up to 30 megacycles.

Has ON-OFF switch, and STANDBY switch.

Complete with tube and crystal . . . Dealer net only . . . . .

**\$14<sup>25</sup>**

See it at your distributor's today. Install one in your BIG TONIGHT!

**BUD CAN SUPPLY ALL YOUR NEEDS!**

. . . with the latest types of equipment including: condensers—chokes—coils—insulators—plugs—jacks—switches—dials—test leads—jewel lights and a complete line of ultra-modern cabinets and chassis.



**BUD RADIO, INC.**

CLEVELAND 3, OHIO

WNBW television producer, took a two-hour-fifteen-minute play, "All Gaul Is Divided," by John McGiver, edited it to an hour's program, enlisted the help of Catholic University's dramatic department, trained the CU cast in television techniques, and came up with a history-making program. Frankly an experiment, it won friends for television and, although involving hard work for everybody concerned, cost very little. Gaunt is also working on dramatization of the stories behind paintings in Washington's National Gallery. At the same time, he is not pessimistic about the television futures in sports events, especially baseball and boxing.

**NEARER TO** actual use by the public on a widespread basis are facsimile transmissions, which the FCC recently announced "may soon become a regular broadcast service." Only thing that's holding things up are rules and standards for the service, and they should be forthcoming soon. Close cooperation by manufacturers, broadcasters, and newspaper publishers brought about the rapid development of the service. On the basis of experimental work in the field, FCC reports that transmission of pictures and printed matter will become rapidly commonplace, with scores of other applications in the offing. For instance, facsimile news service for airplane passengers in flight has proved feasible. The radioed press dispatches were printed on an airliner in four columns at the rate of 500 words a minute. Operations by a New York bank were sped up through rapid transmission of check reproductions from the bank's downtown central signature file to its uptown headquarters. Transmissions were completed in less than a minute. Microwave transmission has been used successfully to relay facsimile from Boston to New York, and the Army Air Forces are planning to use it on a national hook-up for transmitting weather maps. There is even work under way toward using facsimile on the telephone. Seems you can call the girl-friend and if nobody answers can leave a facsimile note asking her where she's been.

**ALSO ON THE FRONT** of the FCC stove is the long-heralded "Citizens Radio Service," in the band of 460-470 megacycles. Manufacturers are already working on pocket-sized sets in this field. All that remains is for them to get into mass production and for FCC to draw up rules and regulations. Tests indicate that the new gadgets will break down about any last barrier that may remain to radio. In FCC's words, "The possibilities for utilizing this type of radio are unlimited." If the girl-friend is in danger of a facsimile note checking up on her doings, the boy-friend is threatened with a direct hook-up with home, regardless of what lengths he has gone

to get away from it all. Private boats and vehicles will be able to use it, possibly even connecting with telephone systems. The boss will be able to break into your fishing activities and your wife will be able to hook you up while you are on a hunting trip. . . . One the credit side of the ledger, widespread use is expected for disasters, ranching, mining, and exploring. How soon the sets will be in your hands is mostly a postwar production problem. Next summer will be the earliest. But once they are available, FCC predicts that licensing will be easy—"a simple procedure requiring no technical knowledge by the prospective user."

**ALTHOUGH SET OUTPUT** showed signs of tapering off from the spring peaks, reports from all along the line indicate that the industry is going to have one of the best years in its history. Set-production drop came in May, but was still in the box-car figure stage—1,316,373 as compared to April's estimated total of 1,548,540. The figures are based on reports from members of the Radio Manufacturers Association. RMA also reported that May saw television production up to 8690 as compared with 7886 for April's five weeks. FM-AM receiver production continued good—84,507. Drop in the total set production was regarded as partly seasonal, and no cause for alarm. Monthly production up to May indicated an annual total of 18,000,000, whereas estimates for a prosperous year early in the spring were for 15,000,000.

**APPARENTLY IN STEP** with the production pace is employment, up 18 per-cent this year in the broadcasting field as compared to the fall of 1945, according to the latest FCC figures. Seven networks and 924 standard broadcast stations employed 34,831 persons in the first week of February this year, 18 per-cent above the October, 1945 figure of 29,405. The 1947 total included 30,100 full-time staff employes and 4731 non-staff program workers. Salaries are also up. Excluding executives, supervisors and non-staffers, the 1947 broadcast employe got an average of about \$61.00 a week, as contrasted with the 1945 figure of \$58.00.

**ALSO IN THE BOXCAR** figure class are anticipated U.S. radio exports this year as estimated by George R. Donnelly of the Department of Commerce. Donnelly figures that the total will go to more than \$60,000,000. This is well ahead of the all-time record radio export year—1944—when the total was \$44,781,289. "Despite many obstacles to trade, radio receiving equipment and components are still being widely distributed abroad," says Mr. Donnelly, who predicts that in 1947 they will "undoubtedly greatly exceed those for 1946." The '46 figure was (Continued on page 185)

*Opportunity now FOR YOU!*

**NATIONAL SCHOOLS SHOP METHOD**

**HOME TRAINING in RADIO**

**TELEVISION and ELECTRONICS**

**A PRACTICAL RESIDENT TRADE SCHOOL**

**With Its Own Shops and Laboratories**

**FOR OVER 40 YEARS**

**TODAY, OPPORTUNITIES IN THE RADIO, ELECTRONICS AND TELEVISION INDUSTRY ARE TAKEN FOR GRANTED**

We see them everywhere: The Home Radio Service Field continues to grow. Television is here . . . Television Broadcasting facilities are being rapidly expanded. Television sales, service, installation and maintenance requirements are more and more important from day to day. Electronics is an important factor in many applications for utility, safety, accuracy and convenience. Airlines are finding new uses for Radio bringing new benefits to air transportation. Ships at sea are employing Radar together with other conventional Radio apparatus for ship-to-shore communications and safety. Frequency Modulation is modernizing Radio Broadcasting, offering static-and-interference-free reception in the home. The list of Radio applications is almost endless, and every one represents increasing opportunities in our modern world for the **RADIO, TELEVISION AND ELECTRONICS TECHNICIAN WITH A SOLID TECHNICAL BACKGROUND.**

**NOT JUST ANY TRAINING WILL DO**

It is not a question of opportunity but rather how to take advantage of existing opportunity. Only proper training can make these opportunities a reality. National Schools of Los Angeles, one of the oldest and largest technical trade schools in the United States, offers you **Shop Method Home Training, a proved method that builds qualified technicians.** Here is Home Training that **BRINGS RESULTS.**

Behind all training from National Schools stands a permanent faculty of experienced instructors and engineers. These men are daily teaching resident students right in our own Shops and Laboratories. From first hand experience with students here at school, our instructors understand the needs and ambitions of men like you. All of our instructors, both Home Study and Resident, have ideal facilities to make your training practical, up-to-the-minute, interesting. It takes years of experience to know how to train men, especially in the practical technical trades. Established almost 50 years ago, National Schools has a rich background of experience to help you to take full advantage of the opportunities in the Radio, Television and Electronics Industry

**HERE'S JUST A FEW OF THE INTERESTING FACTS YOU LEARN WITH THE FREE MANUAL**

1. Routine for Diagnosing Radio Troubles.
2. Preliminary Inspection of Receivers.
3. How to Check Power Supply.
4. How to Identify Various Stages of Receivers.
5. How to Trace the Circuit and Prepare Skeleton Diagram.
6. How to Test and Measure Voltages.
7. How to Test Speaker in Audio Stages.
8. How to Test Detector, I.F., R.F., and Mixer Stages.
9. Complete Reference Table for Quickly Locating Receiver Troubles.

**VETERANS**



During the war, National trained enlisted men under contract with the War Department. Both the Armed Forces Institute and Marine Corps Institute used our lesson texts on a wide scale. Now, we are training veterans, both resident and home study, through the Veterans Administration. If you are a veteran of World War II—and qualified for training under the G.I. Bill of Rights, check the coupon for special information.

**GET THESE 2 BIG BOOKS FREE!**



September, 1947



RADIO SHOP AT NATIONAL



BROADCAST STUDIO AT NATIONAL

Partial View of the Facilities that Stand Behind Your National Schools Home Training



Since 1905

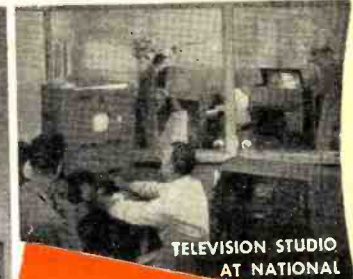

TELEVISION STUDIO AT NATIONAL

**We Bring NATIONAL SCHOOLS to You**



**Begin Training at Home Later Come to Our Shops and Laboratories in Los Angeles —If You Prefer**

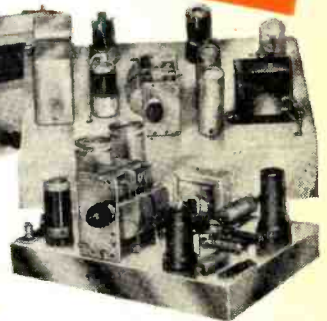

National's Master Shop Method Home Training in Radio, Electronics and Television is **COMPLETE** in itself. No other training is necessary; but, some men do prefer to take a short experience course here in our resident shops and laboratories, at the end of their Home Study training. They find it helpful to spend a short period of time in our modern Broadcasting Station, or our New Television Laboratories and Studios, or our Extensive Radio Servicing Shops—as well as other departments covering every specialized phase of the Radio Industry.

You are welcome to take advantage of this additional instruction if you wish. If you are interested, check the coupon below. Full details will be sent you by return mail. National Schools' **OUTSTANDING FACILITIES MAKE IT POSSIBLE TO OFFER THE FINEST POSSIBLE TECHNICAL TRADE TRAINING IN RADIO, TELEVISION AND ELECTRONICS.**

**You Get All This Radio Experimental Equipment to Use and Keep at Home!**

**LEARN BY DOING** is the basic principle of National's Shop Method Home Training. We send you standard Radio parts for an interesting series of experiments which demonstrate the fundamentals of Radio, Television and Electronics. The very essence of this training is **EXPERIENCE**—you get actual experience by building many different types of circuits. You build a fine, long distance **MODERN SUPERHETERODYNE RECEIVER**, signal generator, low-power Radio transmitter, audio oscillator, etc. This **practical work** develops your knowledge of Radio step by step, makes you a **practical Radio Technician.**

**G. I. APPROVED NATIONAL SCHOOLS**  
LOS ANGELES 37, CALIFORNIA EST. 1905



**MAIL OPPORTUNITY COUPON FOR QUICK ACTION**

NATIONAL SCHOOLS, Dept. 9-RN  
4000 South Figueroa Street, Los Angeles 37, California

Mail me **FREE** the two books mentioned in your ad, including a sample lesson of your course. I understand no salesman will call on me. I have checked below the plan which interests me.

NAME..... AGE.....  
ADDRESS.....  
CITY..... STATE.....  
(Include your zone number)

- I am interested in home study only.
- Send information on your Combined Home-Study and Modern Resident Shop Training.
- Veteran of World War II.

# \$175 AND 25 MONOSETS GIVEN To Winners of This EASY CONTEST!

## RADIO AMATEURS

*Just write 50 words or less telling us why you like the TELEX MONOSET better than old style earphones.*



WIN:

**\$100**

and a MonoSet

**\$50**

and a MonoSet

**\$25**

and a MonoSet

PLUS

TELEX MONOSETS  
to 22 Runner-ups!

### HERE'S ALL YOU DO:

1. Go to your parts jobber and ask him to let you try out the revolutionary under-the-chin TELEX MONOSET.
2. In 5 minutes you'll get at least half a dozen good, WINNING ideas. Be sure to get *all* the facts and an OFFICIAL ENTRY BLANK.
3. Then write 50 words or less telling us "Why the TELEX MONOSET is

Better than Old-Style Earphones." Clearness and sincerity will count most.

4. Print or type your answer on the OFFICIAL ENTRY BLANK your jobber will give you.

Mail direct to: TELEX, INC., Telex Park, Minneapolis 1, Minnesota, before Midnight October 15, 1947.

FIRST PRIZE: \$100.00 cash and a TELEX MONOSET

SECOND PRIZE: \$ 50.00 cash and a TELEX MONOSET

THIRD PRIZE: \$ 25.00 cash and a TELEX MONOSET

TELEX MONOSETS to the 22 next best opinions. In case of a tie, duplicate prizes will be awarded.

Employees of Telex, Inc. and their advertising agency not eligible to enter this contest.

NO BOX TOPS!  
NO JINGLES!  
Get Entry Blank  
From Your Parts  
Jobber

**CONTEST CLOSES MIDNIGHT OCTOBER 15, 1947!**

### TIPS TO GET STARTED WITH:

1. TELEX MONOSET is quickly replacing old-style, cumbersome headsets because you wear it under-the-chin instead of over-the-head.
2. Featherweight: Only 1.2 oz. No ear fatigue.
3. Excellent fidelity. Clear, natural reception of sound.
4. Reliable performance assured by TELEX precision engineering.
5. Exclusive, TELEX designed, volume control—permits individual adjustment of volume.



HEARING AT ITS BEST

**TELEX INC.**

ELECTRO-ACOUSTIC DIVISION

TELEX PARK  
Minneapolis, Minn.

.....  
Decision of impartial judges will be final. All entries become property of Telex, Inc. Winners will be notified by mail approximately November 1, 1947. Contest subject to all state and federal regulations.

Remember, wherever a headset is used—  
TELEX MONOSET will do the job better.

**BRANDED and  
PACKAGED for  
your protection**

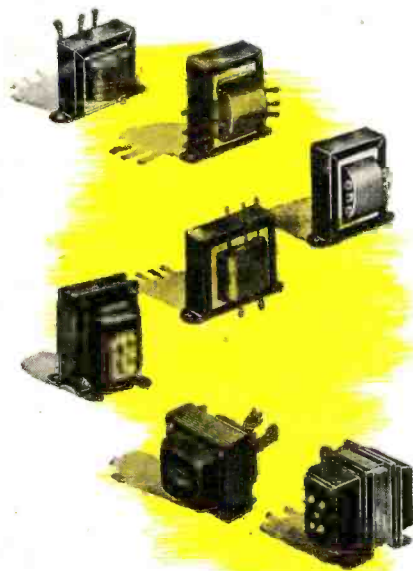

Satisfied customers' goodwill is your surest formula for building a successful service business . . . However—the finest craftsmanship of the serviceman's art is to little avail if not protected against installations of inferior merchandise.

Genuine STANCOR transformers, "first" in the field, is your customer-assurance of the finest, top-quality units . . . and when you use STANCOR you are installing genuine "PROTECTED PRODUCTS," for STANCOR transformers, packed with complete installation instructions, come to you *permanently stamped for guaranteed protection, and expertly packed for your fast identification* . . . Guarantee customer goodwill through STANCOR.

standardize on

**STANCOR**



**TRANSFORMERS**

STANDARD TRANSFORMER CORPORATION • ELSTON, KEDZIE AND ADDISON • CHICAGO 18, ILL.

September, 1947

23

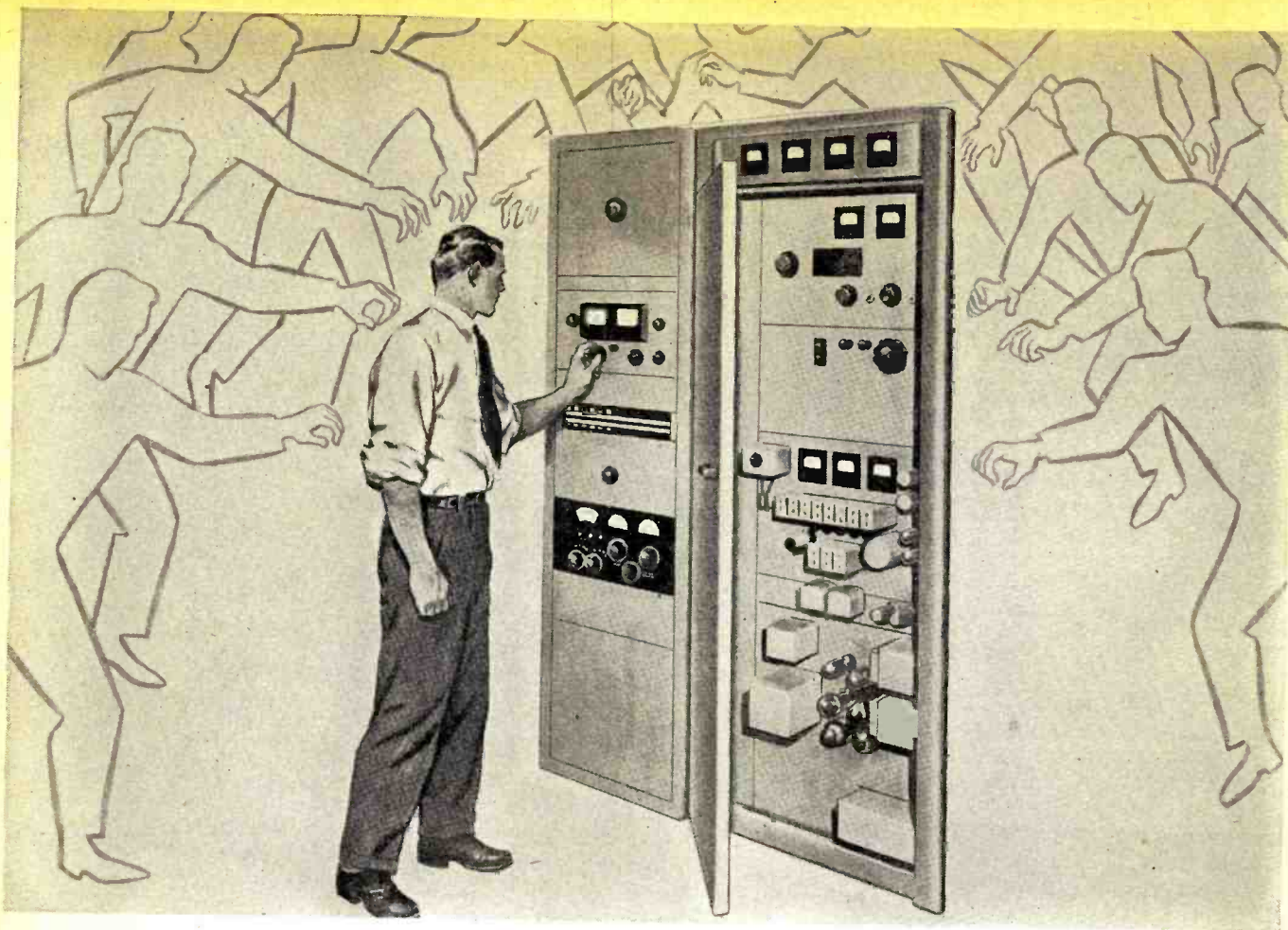

## How Much Competition Have You ... For Your Present Job — For a Better Job?

Again employers can afford to be "selective", particularly with thousands of new, ambitious, young men who have entered the radio industry since the war. This means you must improve your technical knowledge not only to qualify for the better job you want, but to *hold* the job you now occupy.

Your own success in radio depends upon the effort you make *now* to fortify yourself with modern technical training. You may have "gotten by" up to this point. But, if you are like some radiomen, many wartime and postwar technical advances of the industry have passed you by. Developments of the past few years call for an entirely new understanding and knowledge of technical radio practice. If you want to progress with the industry . . . if you want an im-

portant, good-paying position and the future security that goes with it — you must acquire up-to-date technical training.

We invite you to investigate the CREI proved program for professional self-improvement for which thousands of professional radiomen have enrolled since 1927. CREI can help you by providing down-to-earth, practical technical training that should equip you to advance to the better-paying radio jobs that offer security and happiness. CREI home study courses in Practical Radio-Electronics Engineering can equip you to step ahead of competition.

The facts about CREI and what it can do for you are interestingly described in our 24-page booklet. It is well worth your reading. Send for it today.

**VETERANS! CREI TRAINING AVAILABLE UNDER THE "G.I." BILL!**

### MAIL COUPON FOR FREE BOOKLET

If you have had professional or amateur radio experience and want to make more money, let us prove to you we have the training you need to qualify for a better radio job. To help us intelligently answer your inquiry — IN WRITING PLEASE STATE BRIEFLY YOUR BACKGROUND OF EXPERIENCE, EDUCATION and PRESENT POSITION.



## Capitol Radio Engineering Institute

*An Accredited Technical Institute*

DEPT. RN-9 16TH AND PARK ROAD, N. W., WASHINGTON 10, D. C.

Branch Offices: New York (7): 170 Broadway • San Francisco (2): 760 Market St.

### CAPITOL RADIO ENGINEERING INSTITUTE

16th & Park Rd., N. W., Dept. RN-9, Washington 10, D. C.

Gentlemen: Please send me your free booklet, "CREI Training for Your Better Job in RADIO-ELECTRONICS", together with full details of your home study training. I am attaching a brief resume of my experience, education and present position.

Check  PRACTICAL RADIO ENGINEERING Course  PRACTICAL TELEVISION ENGINEERING

NAME .....

STREET .....

CITY ..... ZONE ..... STATE .....

I am entitled to training under the "G.I." Bill.



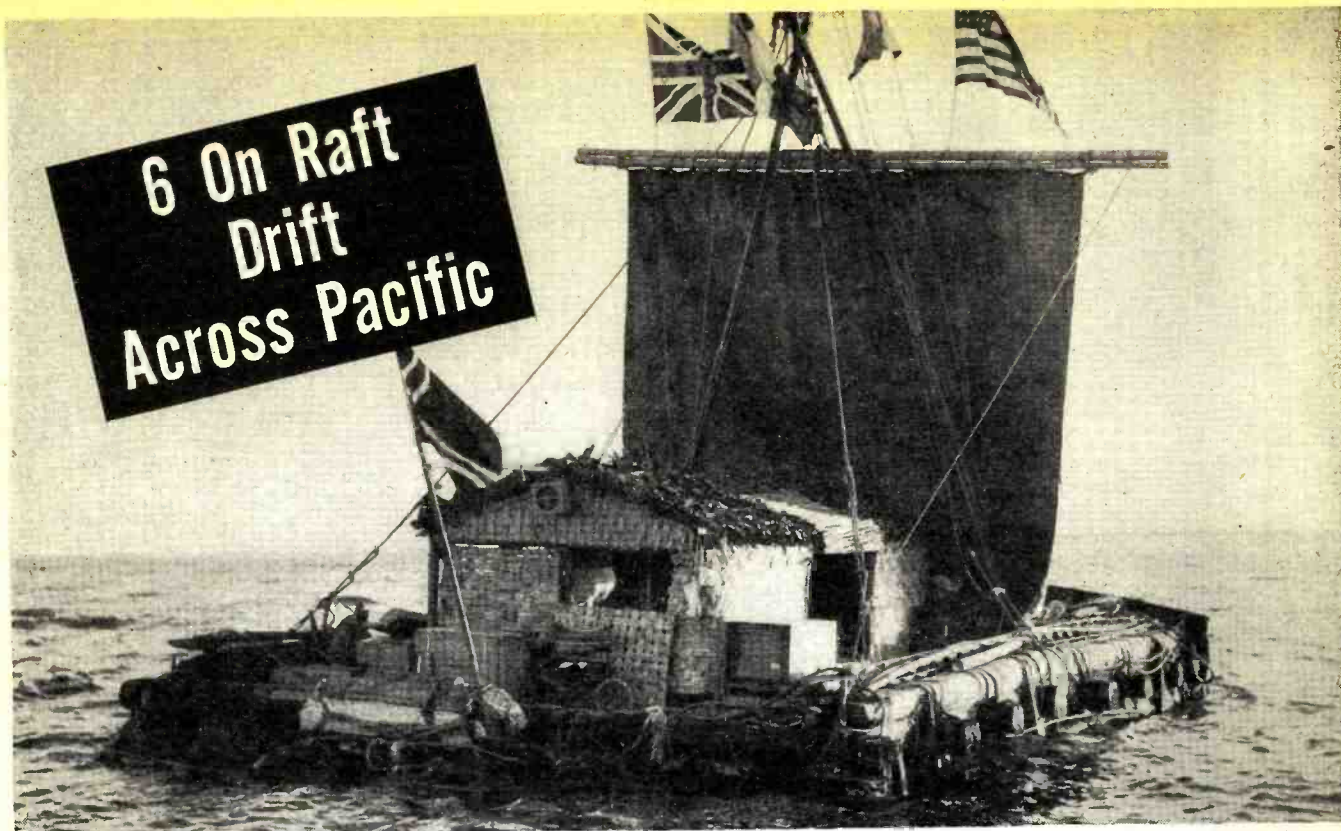

Courtesy of Science Illustrated

## KON-TIKI EXPEDITION PICKS NATIONAL RECEIVERS

Somewhere in the vast loneliness of the Pacific a frail balsa wood raft is drifting westward, carrying six Norwegian scientists toward the Polynesian Islands. Their mission: to prove that the Polynesians could have been settled by prehistoric Peruvian Indians.

Courage, yes, recklessness, no. These adventurers are scientists, not stunt men. Before setting out from Peru they made sure that they would have the finest radio equipment in the world . . . National receivers, of course (Models NC-173 and HRO-7).

For safety . . . to bring in the weakest signal in the worst kind of weather . . . for science . . . to exchange vital weather and navigational data with land stations thousands of miles away. Battered by wind and sea for months on end these superb National receivers aboard the Kon-Tiki Expedition raft are still functioning as reliably as ever.

What better testimonial than operator Knut Haugland's cheerful "All's Well" radioed from the Tuamotu Archipelago . . . 4000 miles across the Pacific, and still going strong.

Congratulations are also in order to W6AOA, W6EVM, and W3YA who have been in regular contact with LI2B. 27.98 and 14.142 megs have been assigned for general contact. Next time you go on the air, why not see if you can contact Haugland and get the Expedition's story first-hand.

**National  
Company, Inc.**  
Malden, Mass.

MAKERS OF LIFETIME RADIO EQUIPMENT

September, 1947



National Receivers of the Type Selected for the Kon-Tiki Expedition

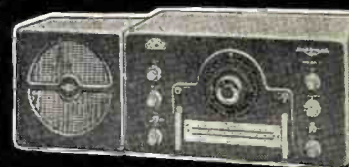

### HRO-7

Brand-new successor to the famous HRO used throughout the world. 11 tubes plus a voltage regulator. . . . Frequency coverage from 50 to 430 and 480 to 30,000 kc. . . . Adjustable Threshold Noise Limiter. . . . Streamlined grey cabinet. AM phone and code reception.



### NC-173

A new and versatile receiver, popularly priced. Frequency coverage from 540 kc to 31 mc plus the 48-56 mc range. Calibrated amateur band spread on 6, 10-11, 20, 40 and 80 meter bands. Phonograph or Microphone pick-up jack.



*Listen*  
...IT'S A  
**Jensen**

**MODEL VH-91**  
*Hypex*<sup>\*</sup> **SPEECHMASTER**

Delivering good quality, intelligible speech with maximum "punch" to override high noise levels, the Model VH-91 Speechmaster is recommended for paging and intercommunication applications. Hypex horn formula gives useful output over a 100° angle.

Especially efficient for voice, the VH-91 has a frequency range of 400-5,000 cycles. Power handling capacity: 15 watts maximum speech signal input. Designed for both inside and out-of-door use, VH-91 will withstand extreme weather conditions, including exposure to salt spray. Nominal voice coil impedance 8 ohms. Transformer number Z-3345, with 5/8" x 5/8" core available for 45-ohm use. Bell diameter, 8 7/8 inches; height, 9-1/16 inches; weight, 4 1/4 pounds.

Universal mounting bracket adjusts projector to any direction, locks securely in position by a single wing nut, has facilities for mounting transformer.

**Jensen VH-91 Speechmaster Projector (ST-171).....\$32.50**

\*Trade mark registered

**JENSEN MANUFACTURING COMPANY**  
6617 S. LARAMIE AVE., CHICAGO 38, U. S. A.  
In Canada: Copper Wire Products, Ltd., 11 King St., W. Toronto J



*Designers and Manufacturers  
of Fine Acoustic Equipment*

# FREE

# to servicemen...



the magazine that makes your service jobs  
easier—faster—more profitable



tells you what to do  
— how to do it — chock  
full of FM and television  
servicing information — simplifies  
complicated jobs — tested ways of  
boosting shop traffic

Here's a magazine which can go a long way toward making your shop *the* radio shop in your community. Every month it is *loaded* with ideas — not impractical, day-dreamy schemes which look good only until you try using them—but down-to-earth, tested plans which have actually been used with success by other servicemen just like yourself. Its convenient, pocket-size pages contain valuable technical data — latest dope on new type tubes — notes on trouble shooting — yes, and dozens of helpful hints which will help you to repair any radio ever made easier, better and twice as fast. Accept "The Capacitor"—every month—with C-D's compliments. Put it to work in your shop speeding up repair jobs — building bigger profits. *Don't wait! Mail coupon below NOW so your FREE subscription will start at once.*

## Read what these successful service men say about "the Capacitor"

**FROM MAINE:** "Your magazine carries much of interest to the serviceman. Keep up the good work."

**FROM MISSISSIPPI:** "The C-D Capacitor is a fine paper. My apprentice uses it to good advantage."

**FROM ILLINOIS:** "I think the C-D Capacitor is one of the finest and most complete publications I have ever had the pleasure of receiving."

**FROM KANSAS:** "Ads in The Capacitor saved me over one hundred dollars on test equipment. A great magazine."

### FREE ADVERTISING FOR SERVICEMEN

Looking for a new signal generator? Want to sell that spare 'scope? Interested in swapping some equipment with other servicemen? *The Trading Post* — which appears every month in "The Capacitor" will carry your ad **FREE**. Cornell-Dubilier Electric Corporation, Dp. RN-9, South Plainfield, N. J.

Mail This Coupon TODAY

CORNELL-DUBILIER ELECTRIC CORPORATION, Dept. RN-9  
South Plainfield, New Jersey

Please enter my name to start receiving "The Capacitor" at once — absolutely free.

Name.....

Firm.....

Address.....

City..... Zone..... State.....

I own my own shop.  I am employed. (Please check one)

1910 1947



**CORNELL-DUBILIER**  
WORLD'S LARGEST MANUFACTURER OF  
**CAPACITORS**

MICA — DYKANOL — PAPER — ELECTROLYTIC  
September, 1947

If it's Radio...  
**HARVEY**  
has it!

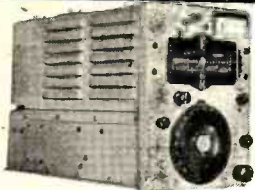

**BC 459A VARIABLE  
FREQUENCY TRANSMITTER**

Frequency range 7 - 9.1 MC. Uses 1626 variable oscillator and parallel 1625's in amplifier. May be used as VFO for all bands from 1 1/4 thru 40 meters with appropriate doublers. Has self contained G.E. hermetically sealed 8 mc crystal oscillator and tuning eye which is used as a check point for dial calibration. Complete with tubes and crystal. Special price .....\$9.95

**SCR 522** - Receiver and transmitter only. In perfect condition. Complete with all tubes, less generator and control box. Get your order in quickly, supply limited. Special price .....\$14.75



**1616 TUBE**

Half wave, high vacuum rectifier. Filament 2.5 volts, 5 amps; peak inverse 5500 volts; peak current .8 amps; surge current 2.5 amps; average plate current .130 amps. List price \$7.50, Harvey special price, while they last.....95¢

**HARVEY HAS IN STOCK  
THE NEW**

**NATIONAL HRO-7 RECEIVER**

This new HRO-7 features many new refinements in receiver circuitry and design. A new automatic adjustable threshold coupler, active noise limiter effectively reduces in interference by external noise pulses. Two new metal type tubes - a 6C4 high frequency oscillator and OA-2 voltage regulator are employed to give a high order of oscillator stability, thereby assuring a minimum of tuning drift.

The HRO-7 is housed in a new completely restyled cabinet with an attractive gray finish. Coils furnished cover 1700 to 30,000 KC. The receiver, complete with coils and power supply but less speaker, is priced at .....\$299.36

**GET YOUR ORDER IN EARLY  
FOR IMMEDIATE DELIVERY**

NOTE: All prices quoted are NET, FOB New York and subject to change without notice.

Telephone: **3 HRC** LOngacre 3-1800

**HARVEY**  
RADIO COMPANY INC.  
103 West 43rd St., New York 18, N. Y.

Within the  
**INDUSTRY**

**BURLINGTON INSTRUMENT COMPANY** of Burlington, Iowa, has recently appointed three new representatives to handle the company's line of electrical indicating instruments, generator voltage regulators, automatic synchronizers, and other electrical control equipment.

Ernest G. Hendrickson of Spokane, Washington will handle the states of Montana, Idaho, and part of Washington. Forrest C. Valentine of Fort Wayne, Indiana will cover Indiana, Kentucky, and part of Ohio, while *White Sales Company* of Boston, Massachusetts will serve customers in the states of Connecticut and Rhode Island.

**ROBERT W. GUNDERSON, W2JIO**, has joined the *Newark Electric Company's* New York staff where he will advise amateurs on their equipment problems.

In addition to his activities as a consulting radio and electronic engineer, Mr. Gunderson is a principal in the new *Minitron Corporation*, specializing in the manufacture of miniature radio and electronic equipment.

Mr. Gunderson devotes his evenings to teaching radio to blind students at the New York Institute for the Blind. He was instrumental in obtaining an amateur license for the only totally blind and deaf ham on the air today.

**CLARK C. RODIMON**, well-known radio amateur, has joined the staff of *National Company, Inc.* of Malden, Massachusetts.

Mr. Rodimon will concentrate on the study, development, and marketing of products sold in the amateur and commercial markets.

He has been associated with the *American Radio Relay League* staff since 1926. He served as Editor of "QST" for over ten years. During the war years, he was granted a leave of absence from "QST" to direct *Raytheon's* Field Engineering programs. He also assisted in government contact service and commercial radar sales.

**CORNELL-DUBILIER ELECTRIC CORPORATION'S** Power Factor Division has practically doubled its manufacturing capacity with the completion of an additional plant of 41,000 square feet area.

The expansion of this division included complete mechanization of the department, extension of a siding into

the plant, and a special conveyor system for transporting heavier loads to and from flat cars.

**LESTER L. KELSEY** has resigned as Vice-President of *The Hallicrafters Co.* of Chicago to accept the position of Vice-President and General Sales Manager of *The Dayton Acme Company* and two of its subsidiaries, the *Osborne Register Company* and the *M. L. Andrews Company*, all of Cincinnati, Ohio.



Mr. Kelsey was associated with *Grigsby-Grunow* and with *Stewart-Warner* as General Sales Manager of the radio division for eleven years before joining *The Hallicrafters Co.*

In his new position Mr. Kelsey will be in charge of sales for the complete line of *Osborne National Food Machines*, *Osborne National Cash Registers*, and other company products.

**A. AUSTIN ELLMORE** has been named Sales Manager and Chief Engineer for *Crescent Industries Incorporated*.

A graduate of DePaul University and a member of the teaching staff of Northwestern University from 1923 to 1927, Mr. Ellmore was formerly associated with *Utah Radio* as Vice-President in charge of Sales and Engineering, a position which he held for the past 18 years.

In addition, Mr. Ellmore is active on seven RMA committees and serves as Chairman of the Committee on Speakers and the Committee on Acoustic Devices.

**NICOLAS ANTON**, Vice-President in Charge of Manufacturing, was elected President of *Amperex Electronic Corporation* of Brooklyn.

Dr. A. Senauke, the retiring President, has become Chairman of the Board of Directors.

**WILLIAM McMILLAN ADAMS** has been added to the executive staff of *Sprague Electric Company* to handle export activities of the organization.

Well-known in business circles, Mr. Adams was formerly associated with the *United States Rubber Company*. He also served as President of the *New York Triplex Safety Glass Company* and was a Managing Director of *Fortnum & Mason, Inc.* of New York.

Mr. Adams, who is a veteran of both World Wars, was educated at Eton College and Cambridge University

**H**  
**IGH SCORER**

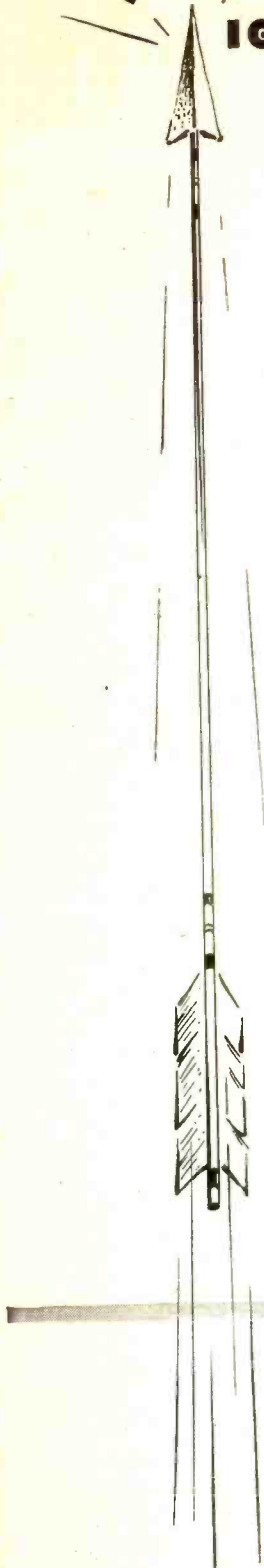

# HQ-129-X

In any contest, Sweepstakes or DX, you will find HQ owners way up among the High Scorers. Why? Because the HQ-129-X has what it takes—plenty of selectivity to dig out those "down under" stations that you have to work if you want to be **HIGH SCORER**.



# HAMMARLUND

THE HAMMARLUND MFG. CO., INC., 460 W. 34<sup>TH</sup> ST., NEW YORK 1, N.Y.  
MANUFACTURERS OF PRECISION COMMUNICATIONS EQUIPMENT

# Lick any Radio Repair Job

## ...IN LESS TIME... WITH LESS WORK!



Alfred A. Ghirardi

### Make More Money in Servicing!

Four radio repair jobs out of every 5 can be handled as easy as falling off a log! Problems that might puzzle you and call for hours of tedious testing can be solved in an instant! Just look up the make and model of the set to be repaired in the Trouble Case History section of Ghirardi's famous RADIO TROUBLESHOOTER'S HANDBOOK. Then go to work! Clear, easily understood instructions tell you exactly what the trouble is likely to be—exactly how to fix it. No lost time or motion. Work twice as fast. Make twice as much money!

### SERVICE DATA ON ALMOST EVERY RADIO USED TODAY!

The 4-lb. 744-page manual-size HANDBOOK contains carefully compiled service notes on over 4800 models of 202 manufacturers—practically every radio in use today. Statistics show it covers well over 90% of all jobs brought to servicemen! Everything fully indexed so you can find it quickly. Everything thoroughly explained. Hundreds of additional pages contain i-f alignment peaks; transformer trouble listings; tube data; and dozens of graphs, diagrams and service data to help you repair ANY RADIO EVER MADE better, easier and TWICE AS FAST! Only \$5 complete—and you don't risk a cent. Our 5-DAY MONEY-BACK GUARANTEE is your absolute protection. Use coupon.

**GOODBYE TO  
TEDIOUS  
TESTING**

Contains repair data on

Admiral	G-E
Airline	Majestic
Arvin	Philco
Belmont	RCA
Capehart	Silvertron
Crosley	St.-Warner
Emerson	Strom-Carl.

... and 198 other makes!



only \$5

### MONEY-SAVING OFFER

Let the HANDBOOK save you time on common service jobs. Let MODERN RADIO SERVICING train you for truly professional work. Get BOTH big books at Combination Price of only \$9.50 for the two. Use coupon today!

only \$5



### Be a Professional RADIO-ELECTRONIC SERVICE EXPERT

Don't be a low-paid service hack! Learn to service by modern, scientific analysis methods. Qualify for the big money work, not only in servicing but in all sorts of industrial electronics. Get the real KNOW HOW of truly professional servicing—in a few short weeks—at home without an instructor—for only \$5 complete!

Whether you're already in servicing or only planning to train for it, A. A. Ghirardi's 1300-page MODERN RADIO SERVICING will prove worth its weight in gold. Clear, illustrated instructions lead you step by step through a complete, easily understood MODERN SERVICING EDUCATION that can equip you for fast, accurate service on even the most complicated jobs. Endorsed by service experts everywhere. Used by leading schools. Unsurpassed for home study. "Borrow" it for 5 full days on our 5-DAY MONEY-BACK GUARANTEE PLAN. You be the judge!

1300 pages  
706 illus.  
766 subjects!

**INSTRUMENTS!  
TROUBLESHOOTING!  
REPAIR!**

MODERN RADIO SERVICING shows how to analyze circuits scientifically; how, when and where to use all types of test instruments; how to test, repair and replace components; how to make parts substitutions; how to handle every phase of radio-electronic repair work by MODERN methods.

### HANDY SERVICE "GADGETS"

Use Ghirardi Gadgets and do radio set troubleshooting and repair with lightning speed! Just flip a card. Automatically, the Gadget indicates the tests and remedies to make for whatever the trouble happens to be.

**HOME RADIO GADGET**—Spots 400 different home receiver troubles—tells what tests to make—suggests how to repair the set. Only 50c.

**AUTO RADIO GADGET**—Indicates 444 special auto radio troubles in all possible sources for 11 common trouble symptoms. Only 50c.

### 5-DAY MONEY-BACK GUARANTEE

Dept. RN-97, Murray Hill Books, Inc.,  
232 Madison Ave., New York 16, N. Y., U. S. A.

Enclosed find \$... for books checked, or  send C.O.D. (no foreign C.O.D.'s) for this amount plus postage. If not satisfied, I may return books within 5 days for refund of my money.

RADIO TROUBLESHOOTER'S HANDBOOK, \$5 (\$5.50 foreign)

MODERN RADIO SERVICING, \$5 (\$5.50 foreign)

MONEY-SAVING COMBINATION: Both big books—over 2040 pages—only \$9.50 for the two (\$10.50 foreign)

HOME RADIO GADGET, 50c  AUTO RADIO GADGET, 50c

Name .....

Address .....

City & Zone ..... State .....

where he majored in mechanical engineering. He has traveled extensively and speaks several languages. He will make his headquarters at the Sprague general offices, North Adams, Massachusetts.

**HERBERT C. ELWES** has been named Manager of Commercial Sound Sales of the RCA Engineering Products Department.

Mr. Elwes, who was formerly Merchandise Manager in the RCA Theater Equipment Section, will now direct sales of industrial sound systems for schools, factories, hotels, and other institutions.

He has been associated with RCA for 16 years during which time he served in various capacities with the company. From 1942 until 1946 he served as an officer in the Army Air Forces, returning to RCA upon receiving his discharge.

**KARL KRAMER** of Jensen Mfg. Co. was named Chairman of the Chicago Section of the Institute of Radio Engineers for the coming year, while Kenneth Jarvis, a consulting engineer, was named Vice-Chairman, and Don Haines of Hytron Radio Corp. was elected Secretary-Treasurer.

While activities of Chicago Section were suspended during the summer months, the first fall meeting will be held on September 19th with the new officers presiding for the first time.

**H. L. PIERCE** was recently named District Merchandising Manager of the Radio and Appliance Division of The Sparks-Withington Company, manufacturers of the Sparton line.



In his new position, Mr. Pierce will cover the territory of eastern Pennsylvania and southern New Jersey. Active in the electrical appliance business for 25 years, Mr. Pierce was most recently merchandising manager of the hard goods division of Mercantile Stores Company, Inc.

Mr. Pierce is forming his own company to be known as H. L. Pierce & Associates. This firm will merchandise the Sparton line.

**NATIONAL ELECTRICAL MANUFACTURERS ASSOCIATION** has announced the formation of a new electrical products group comprising eleven companies which manufacture induction and dielectric heating equipment.

Chairman of the group, known as the Induction and Dielectric Heating Apparatus Section, is Dr. H. B. Osborn, Jr., Sales Manager of the Tocco Division of The Ohio Crankshaft Company of Cleveland. C. W. Miller, Sales Manager of the Industrial Electronics Division, Westinghouse Electric Corp., of Baltimore is Vice-Chairman.

The section will set up equipment standards and ratings, safety requirements (Continued on page 170)



## WHAT'S NEXT-BEST TO HAVING YOUR SERVICE SHOP LOCATED ON A FAMOUS BUSY CORNER?

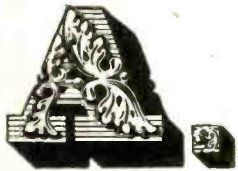
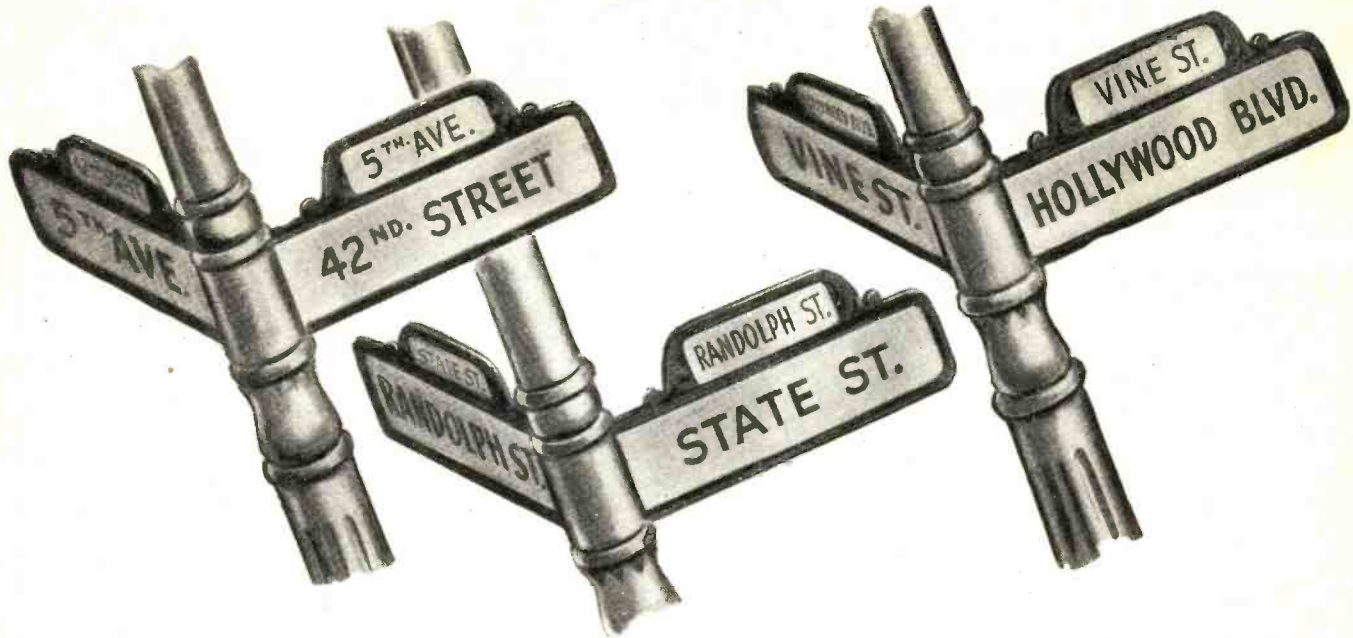

## DISPLAY AND HANDLE GENERAL ELECTRIC TUBES! The popular G-E monogram draws trade to you.



**RADIO  
TUBES**

Public confidence in a well-known, respected product is the voltage that sparks sales. Let radio owners know that you install and sell G-E tubes, and you've taken the first big step toward increasing your volume of business.

Postwar buyers are demanding "name" merchandise. With G-E tubes, you offer customers the brand-name that LEADS in quality, reliability, and engineering advancement . . . stamping you

as a preferred source for tube purchases and trustworthy radio repair work.

Greater patronage of your shop, a bigger volume of service work, faster tube turnover—all these come packaged in the familiar orange-and-blue General Electric cartons. Act *now* to reap the reward that will accrue from establishing your shop as local G-E tube headquarters! *Electronics Department, General Electric Company, Schenectady 5, New York.*

*And General Electric helps you actively promote your business! Write for Sales-aids Booklet ETR-51, which describes the colorful G-E line of tube window displays, direct-mail pieces, and numerous other items useful for widening your client-list and selling more service, tubes, and parts.*

**GENERAL  ELECTRIC**

176-F9-8850

FIRST AND GREATEST NAME IN ELECTRONICS

# A SIGN OF SUCCESSFUL SERVICING



## Community has all fifteen Rider Manuals\*

\*(and Volume XVI on order)

In national magazines it's the successful shops that are featured editorially. Note how many carry photographs showing complete libraries of Rider Manuals. Community Radio and Electric Service of Wilkensburg, Pa. is an example; was recently featured in Radio Retailing for its "Plus-Service". At Community you will find all fifteen volumes in daily use. For, from no other single source is such essential information available to shops called upon to service all makes and all types of radio receivers — of all ages.

For this reason the first fourteen volumes of Rider Manual are time-savingly essential to the average shop. These volumes alone cover the years when over 80% of the sets now in American homes were issued. (From 1920 to 1942 inclusive.)

Too, the information on these receivers is the **OFFICIAL AUTHORIZED** servicing data direct from the service departments of the companies that made the sets. No one knows better than the manufacturer what procedures are best for his product. That is the basis for the authority and the success of Rider Manuals.

And you get this dependable information at the earliest possible date. For, Rider Manuals are now being issued three times a year!

Rider Manuals are investments. They keep pouring out profits for you. Copies of Volume 1, bought 17 years ago, are still benefiting their owners. So, be sure your shop has the sign of successful servicing — all fifteen Rider Manuals.

### RIDER MANUALS NOW IN 16 VOLUMES

Volume XVI (To be published in Oct.)...\$ 6.60  
 Volume XV (Incl. "How It Works" book) 18.00  
 Volumes XIV to VII (Each volume)..... 15.00  
 Volume VI..... 11.00  
 Abridged Manuals I to V (one volume).... 17.50  
 Record Changers and Recorders..... 9.00

#### VOL. XV

2000 Pages, plus 200 page "How It Works" Book

Covers sets issued during 1946 and some previously unpublished pre-war models. Contains 530 Rider-exclusive "clarified-schematics."

\$18.00 COMPLETE

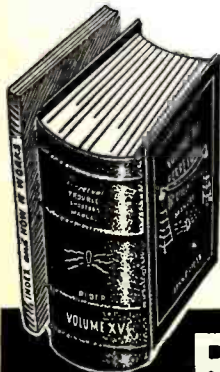

*Just Out!*

### THE TIME-SAVING MASTER INDEX For Rider Manuals

For Vols. VI to XV; Abridged Vols. I to V and RCA-Cunningham Edition. It covers 21,384 pages of Rider Manuals (all editions except Vol. XVI) for years 1919 through 1946.

Contains 40,000 chassis-model cross references and listings. 204 Pages  
 —8½ x 11 inches.

\$1.50

# RIDER MANUALS

MEAN SUCCESSFUL SERVICING

*Out in Oct!*

# VOL XVI

## RIDER MANUAL

704 Pages . . . \$6.60  
 PLUS SEPARATE  
 "HOW IT WORKS"  
 BOOK

*Important  
 Policy*

### *Announcement*

Because of the current high, receiver production rate, Rider Manuals will be issued three times a year, as long as existing conditions continue. This will provide independent servicemen and dealer-service-shops with complete information at the earliest possible date, on those new sets which may require adjustment or repair. This accelerated publishing schedule is but another example of our alertness to meet your radio receiver servicing data needs with greatest economy to you. Rider Manuals represent, "Seventeen Years of Service to the Servicing Industry".

**JOHN F. RIDER  
 Publisher, Inc.**

404 — 4TH AVE., N.Y., (16) N.Y.

Export Agent:  
 Rocke International Corp.  
 13 E. 40th St., New York City  
 Cable ARLAB





*Right . . .*

**FOR TODAY'S NEW CIRCUITS**

**NEW CATALOG LINE OF *CT*  
TRANSFORMERS AND REACTORS**

New and up-to-date, yet embodying all the quality, precision engineering and outstanding construction features for which

Chicago Transformers have long been recognized.

Ratings have been skillfully selected by men who know the latest trends in circuit design. They provide maximum flexibility in application and close matching with today's most widely used tubes.

Audio transformers have 600/150-ohm impedances and contribute to product performance which not only meets but surpasses RMA and FCC standards for high quality reproduction, uniform frequency response over the required ranges, and freedom from distortion. Power transformers meet or surpass RMA standards for temperature rise and insulation test voltages. Combined in the power series are filter reactors with conveniently matched D.C. current ratings.

Transformers and reactors are mounted in drawn steel cases in three variations of CT's famous "Sealed In Steel" construction.

This provides protection against atmospheric moisture, efficient magnetic and electro-static shielding, strength and rigidity to withstand shock and vibration, convenience in mounting, compactness, and clean, streamlined appearance.



**BROADCAST**

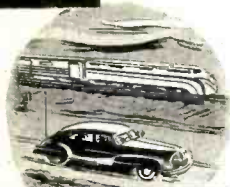

**COMMUNICATIONS**



**PUBLIC ADDRESS**

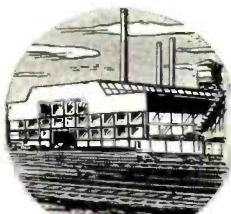

**INDUSTRIAL**



**AMATEUR**



**EXPERIMENTAL**

*Write for Catalog*



**CHICAGO TRANSFORMER**

**DIVISION OF ESSEX WIRE CORPORATION**

**3501 ADDISON STREET • CHICAGO 18, ILLINOIS**

# LEARN EITHER **Electricity** OR **Radio** IN A FEW WEEKS in the GREAT SHOPS of COYNE

**NOT "Home Study" Courses  
...All Practical Training and  
Necessary Theory Given in  
Our Famous Chicago Shops!**

Why spend years learning Electricity or Radio, when COYNE prepares you for good jobs in either field in a few short weeks? Our training not only saves time; you're ready to step into the better pay that much sooner. You make rapid progress because you work under expert instructors here in our great shops. We do not teach by mail. Select course you prefer and send coupon TODAY!

## **ELECTRICITY**



**Including Industrial Electronics**

Big future in Power Plant Work, Motors, Armature Winding, House and Factory Wiring, Industrial Electronics, Home Appliances, Lighting, Auto Electricity, Electrical Maintenance — all covered at COYNE. Here you get "all-around" Electrical training!

**TRAIN ON REAL EQUIPMENT**

You use, test, repair full-size apparatus — just like you'll later handle on the job. Previous experience unnecessary.



### **FREE ELECTRICAL BOOK**

Send now for big, illustrated book on COYNE Electrical Training. Many large pictures of our shops. Tells about Free Lifetime Employment Service to Coyne graduates. Other vital facts. Check coupon for "ELECTRICITY" and mail today.

## **RADIO** including **SOUND** and **TELEVISION**



If you prefer Radio, COYNE gives quick, practical training in Radio Construction, Testing, Repair; also Public Address, Sound Systems, FM, Television. Many branches of Radio open to you.

**Want to be Your Own Boss?**

Hundreds of Coyne graduates have successful Radio shops of their own. We show you how to start, how to build for a lifetime future. No previous experience required to take Coyne Radio Course.

### **FREE RADIO BOOK**

Check coupon for "RADIO" to receive our big FREE book of photos and facts about Coyne Training in Radio, Sound and Television. Describes the vast new opportunities in this field, and how we make it easy to get ahead. Rush coupon NOW.



**B. W. COOKE**

## **COYNE HAS BEEN TRAINING MEN SINCE 1899**

For nearly 50 years, the great shops of COYNE have been turning out men and young men trained for better jobs in practical fields. Coyne graduates hold responsible positions in many leading electrical and radio firms.

**ADDED TRAINING in ELECTRIC REFRIG-ERATION included with either course**

**NON-VETERANS** who are short of cash can finance their tuition and pay it in easy monthly payments after graduation.

**VETERANS!** Coyne is authorized to accept veterans for G. I. training. Coupon brings bulletin.

**COYNE ELECTRICAL SCHOOL**  
Dept. 67-81H  
500 S. Paulina Street, Chicago 12, Ill.

## **CHECK COUPON FOR ELECTRICITY OR RADIO—MAIL NOW!**

**B. W. COOKE, Director,**  
**COYNE ELECTRICAL SCHOOL,**  
500 S. Paulina St., Dept. 67-81H, Chicago 12.  
Send me your **BIG FREE BOOK**—for the special plans to help me, and tell me about your me and no salesman will call.

**ELECTRICITY**                       **RADIO**

NAME.....

ADDRESS.....

CITY..... STATE.....

# 20% PRICE SLASH!

## COMPARE THESE OUTSTANDING VALUES

### APPROVED MODEL A-200 SIGNAL GENERATOR

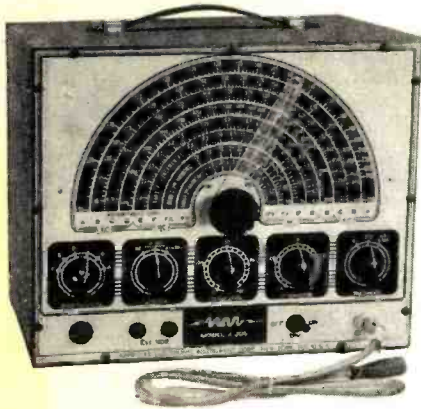

Large Open Face Frequency Dial.

Only Silver Ceramic and Air Trimmers Used.

Multicolor Frequency Dial Scales. (Non-glare design.)

455 KC Position Indicated in Red.

8 RF Bands.

A — 100-250 Kilocycles  
B — 190-500 Kilocycles  
C — 420-1000 Kilocycles  
D — 1000-3000 Kilocycles  
E — 3.0-9.0 Megacycles  
F — 9.0-25 Megacycles  
F<sub>1</sub> — 18-50 Megacycles  
F<sub>2</sub> — 27-75 Megacycles

External Modulation possible at from 40 to 30,000 Cycles.

Internal Modulation at 440 Cycles (same as WWV Standard).  
Phase Shift Audio Oscillator and Internal Modulator.  
A. C. Operation. 105 to 120 Volt. 5' to 60 Cycles.  
Extremely Low Leakage on All Bonds (Power Transformer Electrostatically Shielded)  
Completely Isolated from Power Line.  
Special Wide Spacing, Low Drift "invar metal" Hammarlund Variable Condenser Used as Frequency Selector, Ceramic Insulation Throughout.  
3 Step RF Attenuator.  
Continuously Variable RF-AF Fine Attenuator Control.  
Heavy Gauge Non-Warping Lucite, Fabricated Dial Pointer.  
Tubes used are as follows:  
1—6SN7 - RF Oscillator  
1—6SH7 - AF Oscillator and Modulator  
1—6SH7 - Cathode Follower Output Stage  
1—6x5 - Rectifier  
Negligible Harmonic Output (2nd Harmonic 28 DB Down as measured against higher priced units).  
Specially Designed Ultra Stable Two Terminal RF Oscillator.  
Pilot Light Line Indicator.  
Cathode Follower Output Tube (attenuator settings have no effect whatever on frequency).  
Modulation Percentage continuously variable from front panel, internal or external, 0 to 100%.  
Co-Axial Output Lead Furnished.

The Model A-200 Signal Generator is enclosed in a heavy 16-gauge steel cabinet, battleship grey, crackle finish. Complete with 4 (standard brand) tubes, Amphenol Co-axial connecting cable, ground cable, operating instructions, circuit diagram and guarantee.

Net Weight: 16½ lbs. **Only**  
Size: 8"x10"x12"

REDUCED FROM 4950

**39<sup>50</sup>**  
NET

### FM AT ITS BEST!!



Illustrated is front panel of cabinet. Price includes cabinet.

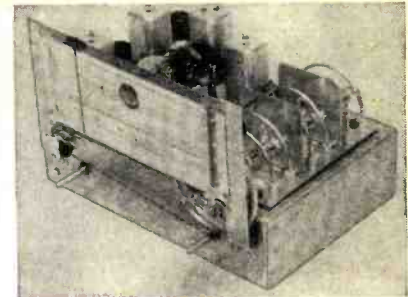

### THE OUTSTANDING F-M TUNER OF THE YEAR!

#### SPECIFICATIONS

POWER SUPPLY: 117 volts, 60 cycles  
POWER CONSUMPTION: 35 Watts  
CIRCUIT: Superheterodyne  
TUNING RANGE: 88-108 Mc  
INTERMEDIATE FREQUENCY: 10.7 Mc (Iron core tuned, ceramic insulation)  
BAND WIDTH: 150 KC  
SENSITIVITY: 10 microvolts for full limiting  
FREQUENCY DRIFT: negligible after 5 minutes  
OUTPUT VOLTS: Average 2 volts RMS.  
OUTPUT IMPEDANCE: 500,000 ohms  
HUM LEVEL: 70 db below average output  
8 TUBES: 1—6AG5 R.F. Amplifier  
1—6J6 Oscillator, mixer, detector  
2—6SH7 I.F. amplifiers  
1—6SH7 Limiter  
1—6AL5 Discriminator  
1—7Y4 Rectifier  
1—6U5 Indicator (Tuning Eye)  
ANTENNA: 300 ohm line (Dipole)  
CHASSIS: No. 16 U.S.S.G. Steel Cadmium plated .0003  
WEIGHT: Approx. 15 lbs. (packed)  
CHASSIS DIMENSIONS: 8x12x3x8½"  
DIAL: Sliderule  
DIAL OPENING: 3x7¾"  
POINTER TRAVEL: 6"  
TUNING RATIO: 16:1  
TUNED LINES: Brass, silver overlay .0005 thick  
CONTACT SPRINGS: Phosphor bronze, silver overlay, .0005 thick  
CONTACT ARMS: Lucite bars  
FRONT END: Unit construction, floated  
CABINET: Walnut Veneer, hand rubbed (13" W, 9¾" H, 10" D)  
CONTROLS: Tuning control—Volume control with "on/off" switch  
Chassis, complete with tubes, built-in power supply, installed in cabinet

**59<sup>50</sup>**  
NET

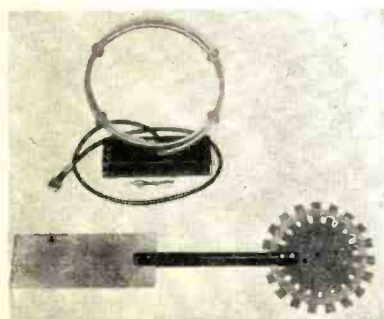

### A RADIATION LOOP AND ALIGNMENT WAND FOR THE SERVICE ENGINEER (CAN BE USED ON ANY SIGNAL GENERATOR)

- Provides loose coupling
- Checks loop-oscillator tracking
- Increases efficiency of receivers
- Helps to eliminate squeals due to misalignment or mistracking
- Enables the service engineer to make gain measurements
- Used exactly like the research and design engineer uses
- Professional appearance and results
- May be used on any signal generator
- Low price
- Saves time

**9<sup>95</sup>**  
NET

#### TERMS

20% DEPOSIT, BALANCE C. O. D.  
OR FULL PAYMENT WITH ORDER

WRITE FOR FREE CATALOG

September, 1947

*Metropolitan* ELECTRONIC & INSTRUMENT CO.

Dept. R, 42 WARREN STREET, New York 7, N. Y., U. S. A.  
Phone: BArlay 7-5556

# CRYSTALS

**SUN RADIO  
COMPLETES  
WORLD'S LARGEST  
PURCHASE OF  
CRYSTALS**



## CRYSTAL FREQUENCY STANDARDS

98.356kc

Easily altered for 100kc  
Standard. Mounted in low-  
loss 3-prong  
holder. **4.49**

In the greatest purchase of radio transmitting crystals ever made by one wholesaler in the history of the Radio Parts Industry Sun Radio acquired title to over a half million dollars (\$500,000.00) of Army Surplus precision built, exactly tooled crystals in moisture-proof holders. Can you visualize the immensity of this stock of ours . . . thousands, or should we say miles, of gleaming brand new crystals in moisture-proof holders manufactured by the world's finest crystal manufacturers (RCA, Bliley, Western Electric, etc.) lying in long rows; lovely to look at but even better to own.

We can't claim we can supply every frequency but we do claim that we can supply you with brand new crystals at the lowest prices you have ever seen. You can now afford to standardize your transmission and frequencies. . . . We say it's Sensational!!! And remember, you may never again see the day that you can buy brand new crystals in moisture-proof holders at the prices that we have offered here. . . . As always, "It's Sun Radio" that comes up with the Best in Values."

400 KC AUDIO  
STANDARD . . . **1.95**

BLILEY 186.30kc  
in type MC 72  
Holder. . . . . **59c**

## CRYSTALS WITH A MILLION USES FRACTIONS OMITTED

412kc	429kc	445kc	469kc	490kc	505kc
413	430	446	470	491	506
414	431	447	472	492	507
415	433	448	473	493	508
416	434	451	474	494	509
418	435	453	475	495	511
419	436	456	477	496	512
420	437	457	479	497	515
422	438	458	481	498	516
423	440	459	483	501	518
424	441	462	484	502	519
425	442	463	485	503	522
426	443	466	487	504	523
427	444	468	488		

**49¢**  
EACH

## I. F. FREQUENCY STANDARDS

450kc	459.259kc
451.388kc	461.111kc
452.777kc	464.815kc
454.166kc	465.277kc
455.556kc	

**99c** EACH

## FOR CRYSTAL CONTROLLED SIGNAL GENERATORS

525kc	533.333
526.388	534.722
527.777	536.111
529.166	537.500
530.555	538.888
531.944	

**99c**

## FOR HAM & GENERAL USE

Fractions Omitted

390kc	396kc	405kc
391	397	406
392	398	407
393	401	408
394	402	409
395	403	411
	404	

**79c**

## ASSORTED MISCELLANEOUS CRYSTALS

Fractions Omitted

370kc	380kc
372	381
374	383
375	384
376	386
377	387
379	388

**39c**

priced at a fraction of the cost of their holders alone.

Payment with order  
Enclose 20c for postage and  
handling  
Minimum order—\$2.00 plus postage  
Please Specify Alternate Choices  
or "No Substitutes."

**SUN RADIO**  
OF WASHINGTON, D. C.

938 F STREET, N. W. WASH. 4, D. C.

# SUPREME PUBLICATIONS

Manuals Available at Your Radio Parts Jobber

## TRAINING BOOKS



### RADIO SERVICING COURSE-BOOK

Just the manual to help you do radio servicing faster. Learn new speed tricks of trouble-shooting, case histories of common faults, short cuts, extra profit ideas. Lessons on test equipment, television, signal tracing. Complete, 22 lessons, self-testing questions, index. Large manual size. **\$2.50**



### HOW TO MODERNIZE RADIOS

Cash in by improving and modernizing all radio sets. Practical job-sheets with schematics and photographs make the work easy. Covers every phase; written for servicemen. Only **\$1.00**

### Simplified Radio Servicing by Comparison



Revolutionary different **Comparison** technique will permit you to make most repairs without test equipment or using only a simple volt-ohmmeter. Plan copyrighted. Presented in manual form, 8½x11", 84 pages, over 1000 service-hints, 26 trouble-shooting blueprints, many charts, 114 tests using a 5c resistor. New edition. Price, only **\$1.50**

### TELEVISION FACTS

Defines and explains every term and part used in television. Great help in studying television. Well illustrated. Only **40c**

### REFRIGERATION

Repair and adjust all domestic units. Charts, pictures to help you. Size 8½x11 inches. Price only **\$1.00**

### PRACTICAL RADIO MATHEMATICS

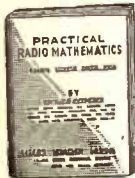

Introduces and explains arithmetic and elementary algebra in connection with units, color code, meter scales, Ohm's Law, alternating currents, ohmmeter testing, wattage rating, series and parallel connections, capacity, inductance, mixed circuits, vacuum tubes, curves, the decibel, etc., and has numerous examples. Plainly written. **25c**

### PRACTICAL RADIO & ELECTRONICS COURSE

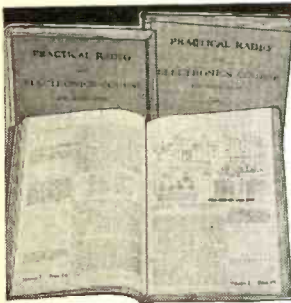

Here is your complete radio education and practical on-the-job handbook at a give-away bargain price. You receive a giant 3-volumes-in-one set, prepared for home-study. Just like a \$150.00 correspondence course, 52 lessons, instructors' hints in margin, self-testing questions, every radio topic. Large manuals, 8½x11", shpg. wt. 4 lbs., 332 pages, 385 charts, drawings, and circuits. Complete, all 3 volumes, postpaid only **\$3.95**

### VOLUME 2, OR VOL. 3, ONLY

You can obtain Vol. 2 of the above course, covering "Receivers, Transmitters, and Test Equipment," or Vol. 3, on "Applied Electronics and Radio Servicing." Price each single volume, only **\$1.50**

### Answer Book to Course

A booklet giving answers to all problems and questions in the above course. Many problems have been worked out in detail and include drawings. **25c**

## DIAGRAM MANUALS

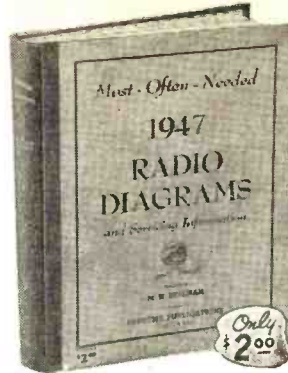

### NEW 1947 CIRCUITS

Be prepared to repair quickly all new 1947 radio sets. In this big single volume you have clearly printed, large schematics, needed alignment data, parts lists, voltage charts, data on gain, location of trimmers, and dial stringing facts for almost all recent sets. Let this manual and the previous six volumes of SUPREME PUBLICATIONS **most-often-needed** diagram manuals help you get ahead and earn more per hour. Used by more than 100,000 shrewd radio servicemen; recommended by your jobber. See and get these manuals today.

**1947 VOLUME 7.** 192 pages. Price **\$2.00**

### MOST-OFTEN-NEEDED RADIO DIAGRAMS



1946, 1942, 1941, 1940, 1939. Each manual has between 192 and 208 pages. Large size: 8½x11". Manual style binding. Price, each Manual only **\$2.00**

1926-1938 Radio Diagram Manual. 240 pages. Price, only **\$2.50**

### STEWART-WARNER MANUAL

### ARVIN DIAGRAM MANUAL

### GENERAL-ELECTRIC MANUAL

64 pages of popular circuits, 5½ x 8½ inches. . . .

PRICE ONLY  
**50¢**  
EACH

**RADIO REPAIRING with SUBSTITUTE PARTS**  
Hints, ideas, suggestions, changes, 32 pages. . . . **25c**

**HOW TO USE DIAGRAMS IN SERVICING** . . . . **10c**

### Pre-War Record Players, Changers, & Recorders

Just what you need to repair quickly thousands of pre-War automatic record changers, manual units, pick-ups, wireless oscillators, recorders, and combinations. Hundreds of mechanical and electrical diagrams. Instructions for adjustments and repairs. Most popular units of all makes. 128 large pages. 8½x11 inches. Price, only **\$1.50**

### Post-War Automatic Record Changers

Service expertly all new (1945-1947) record changers. Follow simplified factory instructions to make needed adjustments and repairs. Hundreds of photographs and exploded views; thousands of test hints; service instructions for all popular makes. Large size: 8½x11". 144 fact-filled pages. At your jobber or postpaid, only **\$1.50**

## NO RISK TRIAL ORDER COUPON

SUPREME PUBLICATIONS, 9 S. Kedzie Ave., Chicago 12, ILL.  
Ship the following manuals: (Satisfaction guaranteed or money back)

Write names of other manuals wanted:

.....  
.....  
.....  
.....  
.....  
.....  
.....  
.....  
.....  
.....  
 I am enclosing \$..... send postpaid.  
 Send C.O.D. I am enclosing \$..... deposit.

**PRICED AT ONLY \$2.00 EACH**

1947  
 1946  
 1942  
 1941  
 1940  
 1939  
 1926-1938 @ \$2.50  
 Pre-War Changers @ \$1.50  
 Post-War Changers @ \$1.50

Name:.....  
Address:.....

**Supreme Publications**

PUBLISHERS OF RADIO BOOKS, MANUALS, AND DIAGRAMS

See Your Radio Jobber or Send Coupon →  
September, 1947

**Save SPACE, TIME and MONEY!**

with the new **PYRAMID**  
**"TUBE-U-LAR"**  
**PAPER CAPACITOR**

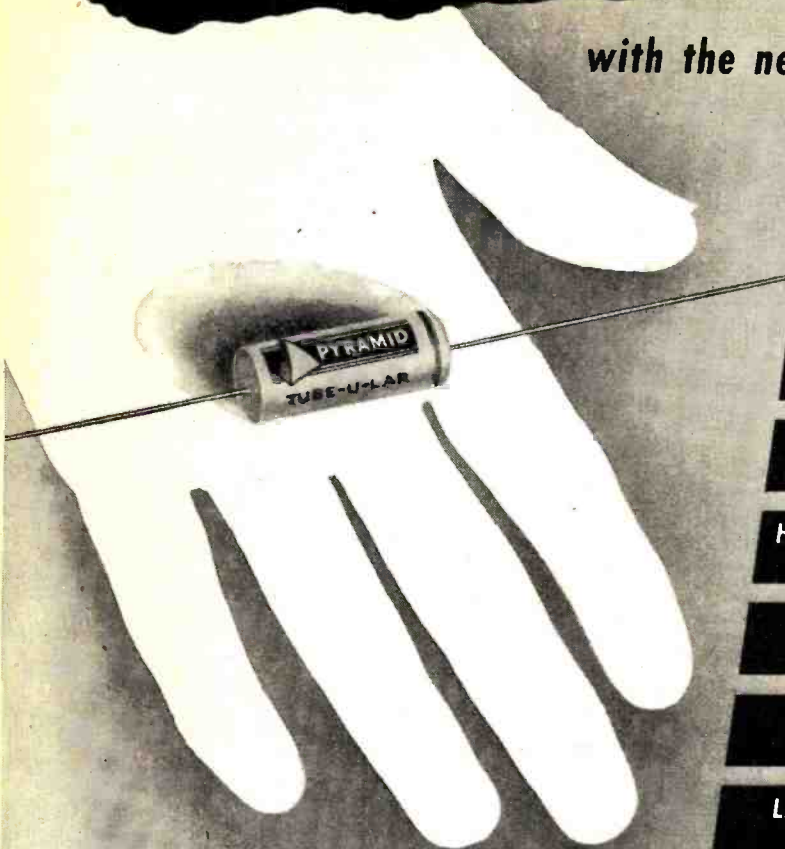

**ULTRA-COMPACT**

**EXCELLENT QUALITY**  
at modest cost

**HIGH INSULATION RESISTANCE**  
lengthens life

**HIGH DIELECTRIC STRENGTH**  
assures against breakdowns

**CLEAN CONSTRUCTION**  
and better appearance

**LARGE, LEGIBLE MARKINGS**  
make identification easy

**SUPERIOR SEAL**  
means dependability in all climates

PART NUMBER	CAPACITY MFD.	D.C. VOLTS WORKING	BODY SIZE, INCHES		LIST PRICE
			DIAMETER	LENGTH	
T6-D1	.001	600	3/8	1 3/8	\$.25
T6-D2	.002	600	3/8	1 3/8	.25
T6-D5	.005	600	3/8	1 3/8	.25
T6-D6	.006	600	3/8	1 3/8	.25
T6-S1	.01	600	3/8	1 3/8	.30
T6-S2	.02	600	3/8	1 3/8	.30
T6-S5	.05	600	3/8	1 3/8	.40
T6-P1	.1	600	3/8	1 3/8	.45
T6-P25	.25	600	3/4	2	.55
T6-P5	.5	600	1	2	.80

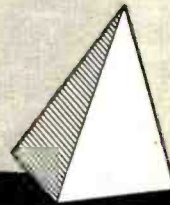

**PYRAMID**

"LONG-LIFE"  
PAPER & ELECTROLYTIC

**Capacitors**

**PYRAMID ELECTRIC COMPANY**

155 OXFORD STREET, PATERSON, N. J.

# Learn as you build—

## Television

By **ARTHUR LIEBSCHER**

Television Consultant, RADIO NEWS

**Complete construction details for an experimental type television receiver. The 3" video tube makes possible simple circuit design and reduces unit cost.**

**F**OR those who believe in learning by doing, the construction of a miniature 18 tube television receiver described here provides a practical way of becoming acquainted with the basic requirements of both picture and FM sound reception.

There are three ways in which this small video receiver can be assembled; first, by the usual method employed by experienced constructors in following the schematic diagram and referring to a photo of the completed set; second by following a step-by-step procedure in mounting and wiring parts as guided by a series of construction photos; and third, by typical factory production methods.

A school, for instance, can teach mass production as well as the technical side of television, by arranging for a group of students to build a number of sets simultaneously, each being assigned to one operation at a time and personally applying it to all units under construction. Even those with experience will find considerable pleasure in the step-by-step method of assembling numbered parts and thus gradually bringing the entire television set into being.

It is the purpose of this article to explain the construction by the method most commonly practiced, by

Many constructors prefer to work from factory-size blueprints. A 16" x 24" blueprint of the schematic shown on page 40 is available from the author at \$1.00 per copy. Send your requests along with a remittance of \$1.00 to Arthur Liebscher, 7618 Fayette Street, Philadelphia 38, Pennsylvania.



Front panel view of television receiver. The cabinet was home constructed. Controls from left to right are: (top) vertical hold, contrast, tuning, (bottom) horizontal hold, brightness, channel, and volume.

means of the schematic and photographs.

### Chassis Layout

Due to the care required in developing compact high frequency electronic equipment and in particular the con-

sideration of lead lengths and component placement, it is highly desirable that the layout of the original model be copied as closely as possible.

The r.f. "head end" including the tuning facilities, oscillator, and mixer tubes are grouped at the front of the

Side view shows position of video tube and semi-permanent controls.

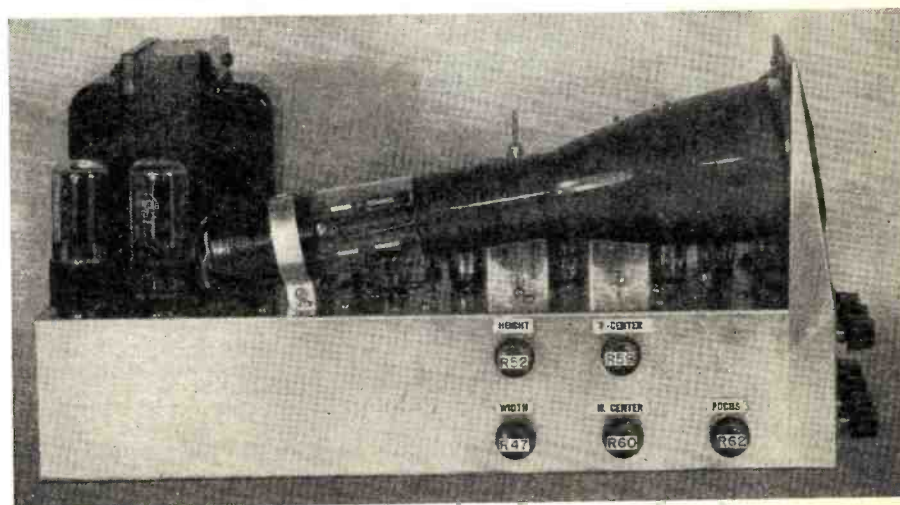

- V1-R.F. OSCILLATOR
- V2-MIXER
- V3, V4, V5-PICTURE I. F.
- V6-DETECTOR
- V7-VIDEO
- V8-VIDEO I. F.
- V9-DISCRIMINATOR
- V10-SOUND I. F.
- V11-SYNC OSCILLATOR
- V12-HOR. OSCILLATOR
- V13-VERT. OSCILLATOR
- V14-LOW VOLTAGE RECTIFIER
- V15-HIGH VOLTAGE RECTIFIER
- V16-OSCILLOSCOPE
- V17, V18-AUDIO

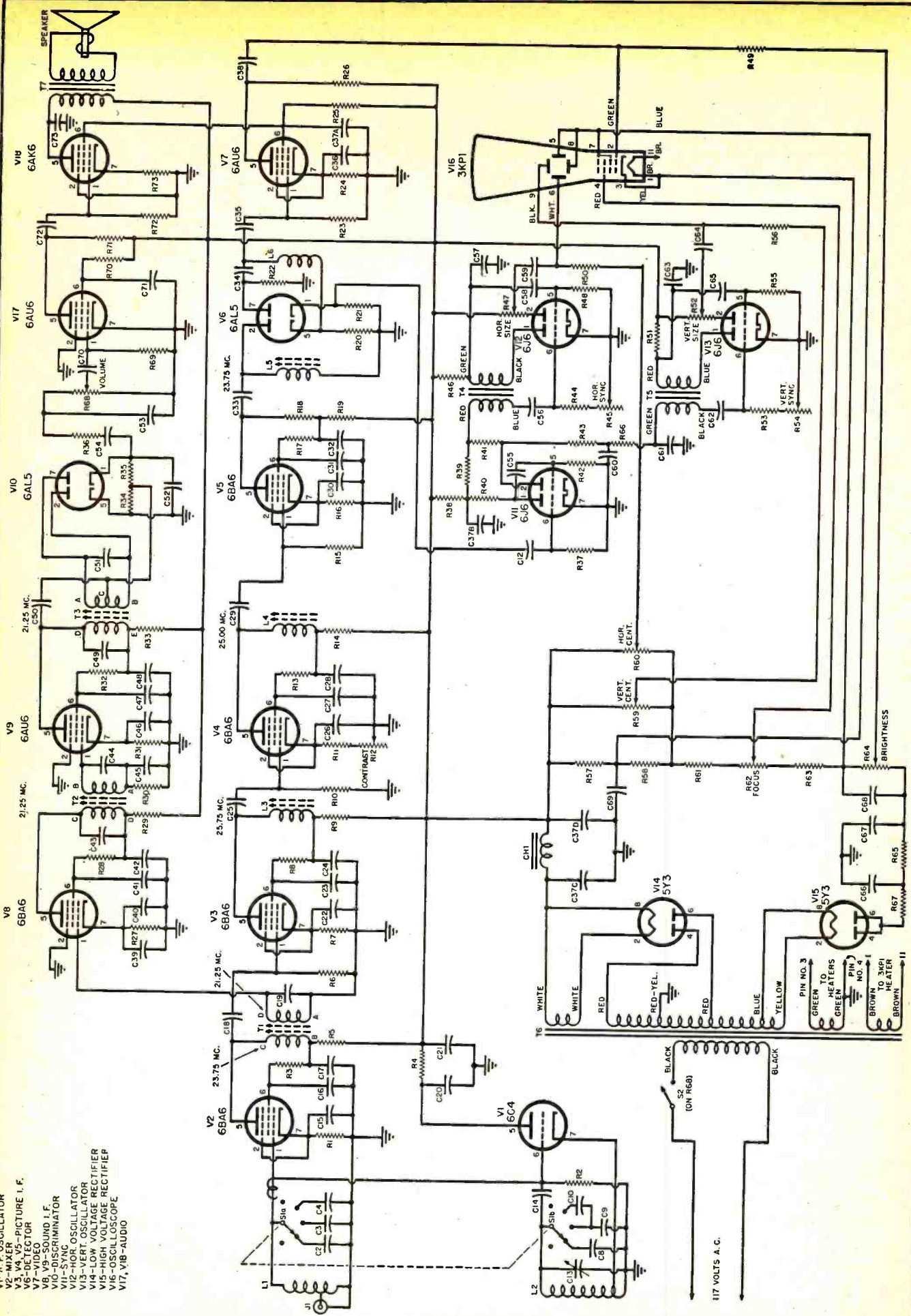



Complete schematic diagram of a.c.-operated 18 tube table model television receiver.

chassis for obvious ease of control. Immediately following the r.f. section is the first picture i.f. stage and this in turn followed closely by the succeeding picture i.f. stages, the detector, and, last, the video amplifier. You will note that this entire picture signal section is laid out in a straight line, terminating where the output can be applied directly to the base of the cathode-ray tube.

The sound i.f. channel is "tapped off" of the mixer output and it too, runs in a straight line layout through the two i.f. stages to the FM discriminator tube (V<sub>10</sub>). The audio signal is conducted back to the volume control on the front panel and then through the two audio amplifier stages grouped at the right side of the chassis under the speaker. This makes the

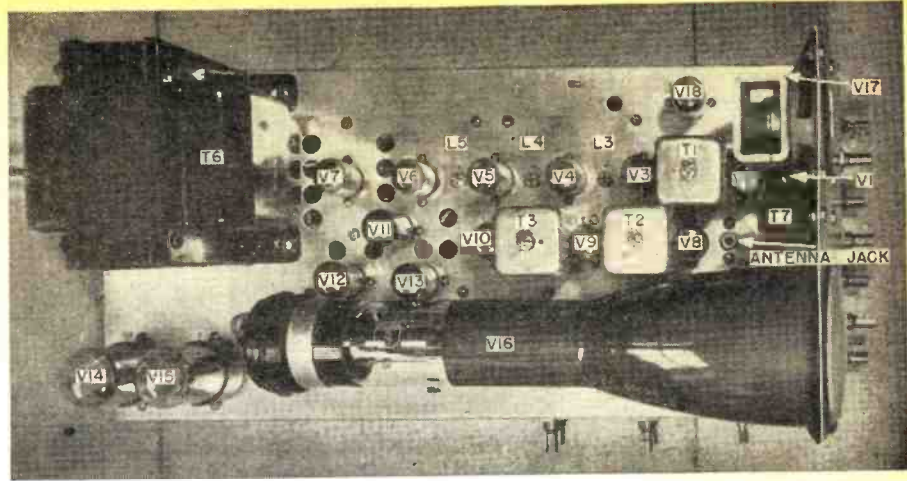

Top view shows placement of component parts. The chassis is 15"x7"x3". In order to conserve space, all component parts should be as small as possible, resistors and condensers should be of the insulated type. It is of utmost importance that the constructor follow the original layout of parts as closely as possible in order to duplicate the results which have been achieved by the author.

- R<sub>11</sub>, R<sub>17</sub>, R<sub>111</sub>, R<sub>116</sub>, R<sub>27</sub>—68 ohm, 1/2 w. res.
- R<sub>1</sub>—24,000 ohm, 1/2 w. res.
- R<sub>2</sub>, R<sub>8</sub>, R<sub>12</sub>, R<sub>17</sub>, R<sub>28</sub>, R<sub>32</sub>—47,000 ohm, 1 w. res.
- R<sub>3</sub>—2200 ohm, 1 w. res.
- R<sub>5</sub>, R<sub>9</sub>, R<sub>14</sub>, R<sub>19</sub>, R<sub>29</sub>, R<sub>33</sub>, R<sub>39</sub>, R<sub>43</sub>—1000 ohm, 1/2 w. res.
- R<sub>6</sub>, R<sub>18</sub>, R<sub>21</sub>—6800 ohm, 1/2 w. res.
- R<sub>10</sub>—8200 ohm, 1/2 w. res.
- R<sub>12</sub>—10,000 ohm rheostat (IRC DS 14-116)
- R<sub>15</sub>—5600 ohm, 1/2 w. res.
- R<sub>20</sub>—3900 ohm, 1/2 w. res.
- R<sub>22</sub>, R<sub>49</sub>, R<sub>50</sub>, R<sub>70</sub>—1 megohm, 1/2 w. res.
- R<sub>23</sub>, R<sub>59</sub>, R<sub>75</sub>—470,000 ohm, 1/2 w. res.
- R<sub>34</sub>—120 ohm, 1/2 w. res.
- R<sub>35</sub>—33,000 ohm, 1 w. res.
- R<sub>36</sub>—8200 ohm, 2 w. res.
- R<sub>39</sub>, R<sub>34</sub>, R<sub>35</sub>, R<sub>37</sub>, R<sub>38</sub>—100,000 ohm, 1/2 w. res.
- R<sub>41</sub>—100 ohm, 1/2 w. res.
- R<sub>42</sub>, R<sub>43</sub>, R<sub>46</sub>—10,000 ohm, 1/2 w. res.
- R<sub>47</sub>, R<sub>48</sub>, R<sub>49</sub>, R<sub>53</sub>—2.2 megohm, 1/2 w. res.
- R<sub>51</sub>—3300 ohm, 1 w. res.
- R<sub>52</sub>—15,000 ohm, 1 w. res.
- R<sub>53</sub>—10,000 ohm, 1 w. res.
- R<sub>54</sub>—3300 ohm, 1/2 w. res.
- R<sub>55</sub>—50,000 ohm rheostat (IRC DS 11-123)
- R<sub>56</sub>, R<sub>65</sub>—220,000 ohm, 1/2 w. res.
- R<sub>57</sub>—50,000 ohm pot.
- R<sub>58</sub>—1.5 megohm, 1/2 w. res.
- R<sub>59</sub>—250,000 ohm pot. (IRC DS 11-130)
- R<sub>64</sub>—2 megohm rheostat (IRC DS 13-139V)

- R<sub>75</sub>, R<sub>80</sub>—10 megohm, 1/2 w. res.
- R<sub>89</sub>, R<sub>90</sub>, R<sub>92</sub>, R<sub>95</sub>—500,000 ohm pot. (IRC DS 11-133)
- R<sub>91</sub>—820,000 ohm, 1/2 w. res.
- R<sub>93</sub>, R<sub>71</sub>—330,000 ohm, 1/2 w. res.
- R<sub>94</sub>—100,000 ohm pot. (IRC DS 11-128)
- R<sub>97</sub>—33,000 ohm, 1/2 w. res.
- C<sub>1</sub>, C<sub>5</sub>, C<sub>7</sub>—See text
- C<sub>2</sub>—15 µfd. ceramic cond.
- C<sub>3</sub>—10 µfd. ceramic cond.
- C<sub>4</sub>, C<sub>6</sub>—6.8 µfd. ceramic cond.
- C<sub>8</sub>—Not used
- C<sub>9</sub>—4.7 µfd. ceramic cond.
- C<sub>10</sub>—8.2 µfd. ceramic cond.
- C<sub>12</sub>, C<sub>35</sub>, C<sub>35</sub>, C<sub>37</sub>, C<sub>72</sub>—.01 µfd., 600 v. cond.
- C<sub>13</sub>—Var. cond.
- C<sub>14</sub>—56 µfd. ceramic cond.
- C<sub>15</sub>, C<sub>19</sub>, C<sub>17</sub>, C<sub>18</sub>, C<sub>20</sub>, C<sub>21</sub>, C<sub>22</sub>, C<sub>23</sub>, C<sub>24</sub>, C<sub>25</sub>, C<sub>29</sub>, C<sub>27</sub>, C<sub>28</sub>, C<sub>30</sub>, C<sub>31</sub>, C<sub>32</sub>, C<sub>33</sub>, C<sub>34</sub>, C<sub>36</sub>, C<sub>38</sub>, C<sub>40</sub>, C<sub>41</sub>, C<sub>42</sub>, C<sub>43</sub>, C<sub>46</sub>, C<sub>47</sub>, C<sub>48</sub>, C<sub>50</sub>, C<sub>53</sub>, C<sub>55</sub>, C<sub>57</sub>—1000 µfd. ceramic cond.
- C<sub>16</sub>—Part of T<sub>1</sub>
- C<sub>31</sub>, C<sub>34</sub>, C<sub>39</sub>—1 µfd., 400 v. cond.
- C<sub>30</sub>—25 µfd., 25 v. elec. cond.
- C<sub>37A</sub>, C<sub>37B</sub>, C<sub>37C</sub>, C<sub>37D</sub>—20/20/20/20 µfd., 450/450/450/450 v. elec. cond.
- C<sub>38</sub>—.002 µfd., 1600 v. cond.
- C<sub>43</sub>, C<sub>44</sub>—Part of T<sub>2</sub>
- C<sub>40</sub>, C<sub>50</sub>, C<sub>51</sub>—Part of T<sub>3</sub>
- C<sub>52</sub>—500 µfd. ceramic cond.
- C<sub>51</sub>, C<sub>65</sub>, C<sub>77</sub>—.05 µfd., 400 v. cond.

- C<sub>56</sub>—820 µfd. mica cond.
- C<sub>60</sub>, C<sub>61</sub>, C<sub>70</sub>, C<sub>75</sub>—.005 µfd., 600 v. cond.
- C<sub>62</sub>—1500 µfd. mica cond.
- C<sub>63</sub>, C<sub>68</sub>—.25 µfd., 400 v. cond.
- C<sub>64</sub>, C<sub>67</sub>—.1 µfd., 1600 v. oil-filled cond.
- L<sub>1</sub>\*—Ant. coil
- L<sub>2</sub>\*—Osc. coil
- L<sub>3</sub>, L<sub>4</sub>, L<sub>6</sub>\*—Video i.f. coil
- L<sub>5</sub>\*—Peaking coil
- CH\*—Filter choke
- T<sub>1</sub>\*—First i.f. trans.
- T<sub>2</sub>\*—Sound i.f. trans.
- T<sub>3</sub>\*—Discriminator trans.
- T<sub>4</sub>\*—Horizontal osc. trans.
- T<sub>5</sub>\*—Vertical osc. trans.
- T<sub>6</sub>\*—Power trans.
- T<sub>7</sub>\*—Output trans.
- J<sub>1</sub>\*—Ant. connector jack
- S<sub>1</sub>\*—5 pos., double-pole rotary selector sw.
- S<sub>2</sub>\*—S.p.s.t. sw. on R<sub>65</sub>
- Speaker—2" PM speaker
- 1—3KP1 cathode-ray tube
- 2—5Y3 tubes
- 3—6BA6 tubes
- 4—6AU6 tubes
- 5—6AL5 tubes
- 6—6AK6 tube
- 7—6C4 tube
- 8—6J6 tubes
- \*—All special components are available from the author.

Parts list for 3" television receiver. Schematic diagram is shown on page 40.

Chart gives actual operating voltages at socket connections of the various tubes.

Tube	Pin No. 1	Pin No. 2	Pin No. 3	Pin No. 4	Pin No. 5	Pin No. 6	Pin No. 7	Pin No. 8	Pin No. 9	Pin No. 10	Pin No. 11
V <sub>1</sub>	+270	—	6.3 a.c.	0	+270	-15	0				
V <sub>2</sub>	0	+1.6	6.3 a.c.	0	+290	+72	+1.6				
V <sub>3</sub>	-.5	+1.2	6.3 a.c.	0	+295	+115	+1.2				
V <sub>4</sub>	0	+1.2/+36	6.3 a.c.	0	+290/+310	+100/+280	+1.2/+36				
V <sub>5</sub>	0	+1.2	6.3 a.c.	0	+210	+100	+1.2				
V <sub>6</sub>	0	0	6.3 a.c.	0	+2	—	-.7				
V <sub>7</sub>	0	+1.3	6.3 a.c.	0	+240	+170	+1.3				
V <sub>8</sub>	0	0	6.3 a.c.	0	+285	+100	+1				
V <sub>9</sub>	+1	0	6.3 a.c.	0	+290	+160	+1.1				
V <sub>10</sub>	0	-.4	6.3 a.c.	0	0	—	-.4				
V <sub>11</sub>	+100	+100	6.3 a.c.	0	-.8	-.9	0				
V <sub>12</sub>	+8/+40	+90/+210	6.3 a.c.	0	-1/-7	-4/-13	0				
V <sub>13</sub>	+100/+140	+90/+120	6.3 a.c.	0	-2.8/-4	-44/-62	0				
V <sub>14</sub>	—	+380	—	400 a.c.	—	400 a.c.	—	+380			
V <sub>15</sub>	—	910 a.c.	—	-980/-1020	—	-980/-1020	—	910 a.c.			
V <sub>16</sub>	-620/-800	-580/-680	-620/-800	-220/-610	+220/+270	+215/+300	+220/+270	+220/+270	+210/+280	—	-620/-800
V <sub>17</sub>	.9	0	6.3 a.c.	0	+95	+45	0				
V <sub>18</sub>	0	0	6.3 a.c.	0	+280	+170	+10				

Note: Line voltage is 117 v., 60 cycles. Meter used is RCA Volt-hmyst. No external signals applied. See schematic diagram for pin numbers.

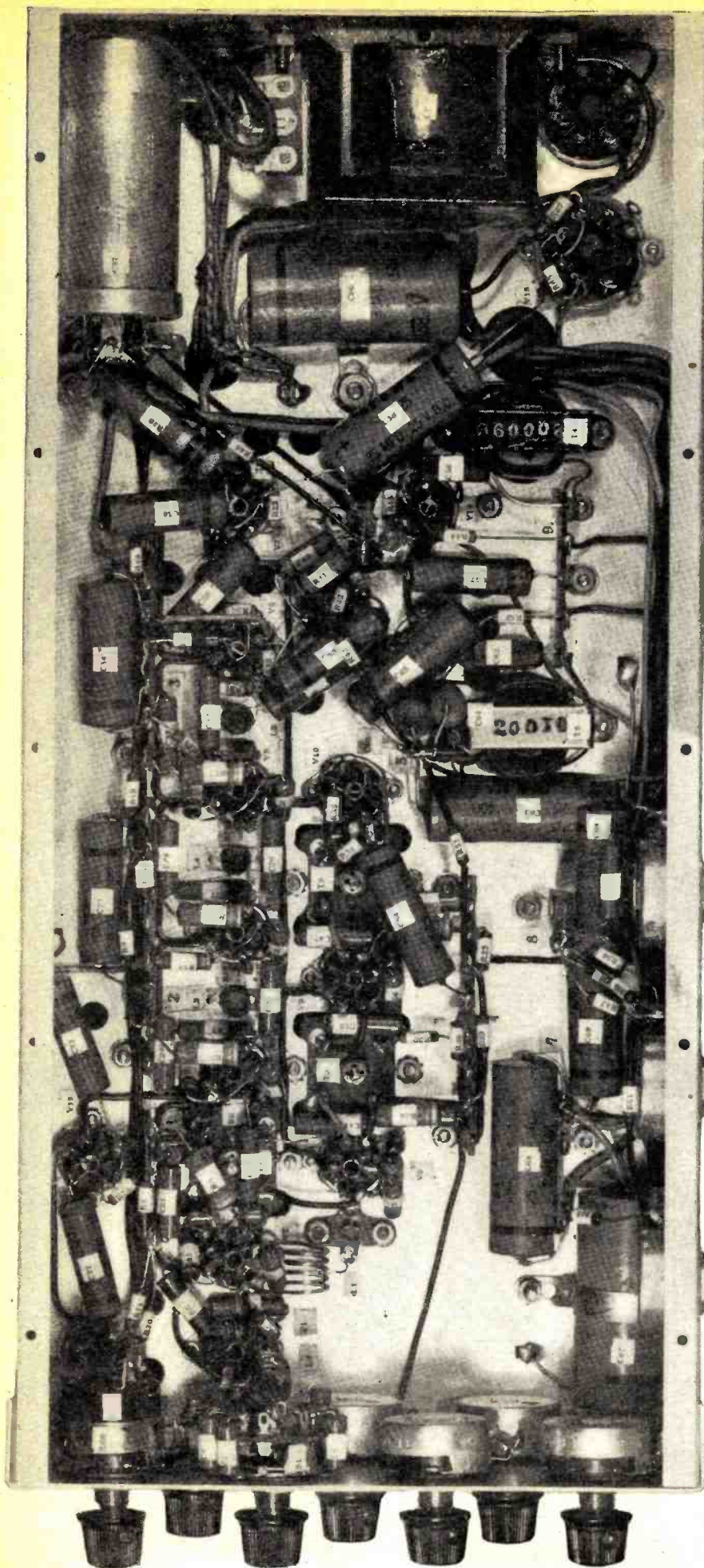

audio output convenient to the panel mounted transformer and speaker.

Synchronizing and deflection tube circuits are placed at the end of the picture channel, where their high level signals are least likely to interfere with the sensitive input circuits.

The power supply is logically placed at the rear of the chassis, thus allowing its heat to ventilate away from most components. The power transformer is purposely mounted with its core at right angles to the cathode-ray tube in order to minimize magnetic hum deflection, which would in turn cause an "s" bend in the picture.

The vent holes are grouped in the top of the chassis at locations where maximum heat must be dissipated. This, plus a perforated base plate and four quarter-inch high feet, serves to provide sufficient ventilation.

Five semi-permanent adjustment controls are clustered on one side of the chassis. They can either be slotted for screw driver adjustment or used with knobs to center and focus the picture as well as adjust its size. The side controls, like the seven on the front, all have shafts cut to one-half inch beyond the mounting thread. If the set is to be installed in a cabinet later, it will be found convenient to simply add shaft extensions to each of the front controls.

#### Selecting Parts

In obtaining parts for the miniature television receiver, care should be exercised in duplicating as many of the original components used in the design models as possible.

Because of the compactness of layout, the size of some items becomes an important factor. This is evidenced in the use of a number of 400 volt paper condensers in lieu of the usual 600 volt size. It is also true of the i.f. transformers, which for the sake of maintaining short leads, are placed directly next to their associated tubes. If a neat wiring job is expected, all resistors and ceramic condensers must be of the insulated type and they must also be small enough to allow room for other nearby parts.

From the standpoint of electrical specifications, little need be said about the importance of obtaining i.f. coils and transformers which can be relied upon to tune properly when a signal is applied. The power and a.f. transformers, too, must be selected for their conformance to the original types.

All the parts should first be accumulated and then checked against the parts list. They should then be laid out on a suitable table area in groups, with

*(Continued on page 133)*

← Under chassis view of completed television receiver. All leads should be as short as possible and placement of component parts should follow the author's layout closely.

# Servicing Television Receivers

By

**PAUL H. WENDEL**

Associate Editor, RADIO NEWS

**Care must be exercised in repairing TV sets to prevent serious personal injury. Video tubes that may implode and high voltages are danger spots.**

**L**ATE in 1946 the first of the post-war television receivers were made available to the public. First sold in the areas where television broadcast programs were on the air, the sales campaigns have been expanded to cover new tele-served areas as additional broadcasting stations are put into operation.

To date the independent radio service dealers have been merely interested bystanders in the video receivers service programs. The initial manufacturers with a tremendous financial investment in video research and development to protect, have buttressed their television sales programs with factory-controlled installation and service. The standard practice now is to charge the customer a flat fee for the installation and for one year's service on the receiver.

Practically all television receiver manufacturers are convinced that factory-controlled service will not be practical when television programs become available in all major areas. They feel that as soon as independent service dealers acquire the know-how and equip their shops with the test equipment essential for video receiver servicing, this activity should be handled by these qualified independent service organizations.

During the war when blithe imaginations drew fanciful word pictures of the flood of spectacularly new products that would enliven our lives after the dawn of Peace, many radio servicemen looked hopefully for the coming of television as the source of



All video tubes are implosive by nature. The larger they are the more dangerous they become and therefore should always be handled with care.

bigger and more profitable service business. Television is now here and in the cold light of business reality servicemen are able to appraise the practical potential of television servicing and what it will take to be able to handle video receiver servicing profitably. It will present new problems unlike anything previously handled in radio repair shops and will require the skillful use of test equipment comparable to the precision equipment of a first-class radio laboratory.

The frequencies now allocated to television range up to 216 mc., and the trend toward larger direct viewing and projection tubes means that radio servicemen will face new problems of high voltage at high frequency. In direct-viewing sets voltages will range from 2500 to 10,000. Projection type tubes will require voltages as high as 30,000.

These high voltages create a problem of serious hazard to the set owner, the radio serviceman and the equip-

*(Continued on page 151)*

**Don't ignore warnings of high voltage or take chances as this serviceman is doing.**

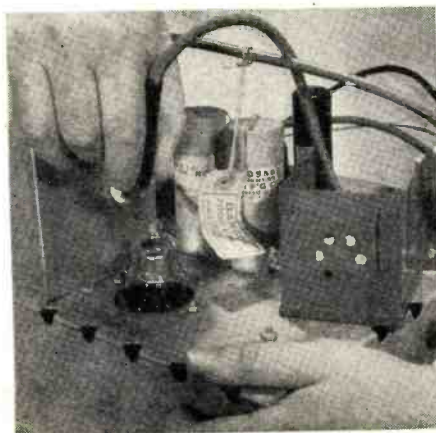

**Always discharge high voltage condensers before touching internal components.**

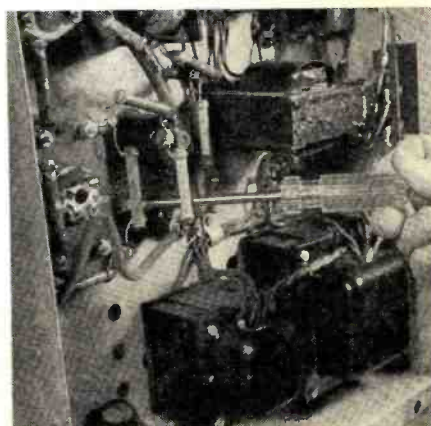

# TELEVISION INSTALLATION

By

W. W. WAYE



Fig. 1. The best location for television antenna is determined by testing various roof positions with a portable probing dipole, connected to the television set. Results are communicated to technician on roof by means of a telephone network.

**Part 1. The dealer's bugaboo—TELEVISION  
INSTALLATION—and how to beat it.**  
**Introducing a series of articles covering  
the basic problems and procedures  
involved in the installation of TV units.**

**T**HE major headache that confronts television merchandising is the bugaboo of *installation*. As more and more television receivers reach the market, the problem assumes enormous proportions.

You, as a dealer or serviceman, can understand the problem only by realizing the important *need* for good installations.

You can beat the bugaboo by following a *Basic Procedure of Installation*—a simple and practical method, that's applicable to all types of commercial television receivers. This is plain talk about television installation. It's down-to-earth, and mostly *non-technical*. You don't have to be an engineer to make a good television installation.

Television, like any other business, must be successful to survive. But the key to sales success in television is more than just a good product, a good line of receivers. After every sale, it's a clear and important responsibility of the dealer to install the set in the buyer's home or place of business. You may be a crackerjack salesman on the showroom floor, but unless the television receiver is properly installed, your sales effort will be lost. Dissatisfied customers will not only squawk to *you*, but to their friends who may be on the verge of buying a set. Television, itself, gets a black eye that it doesn't deserve.

Recently in New York, a leading receiver manufacturer stated: "In running down complaints of faulty set operation, we found that 90 per-cent were due entirely to imperfect installations!" Then he added: "Many of the dealers involved frankly admitted

they couldn't understand the *reason* for painstaking, time-consuming television installations." Unfortunately, this is typical.

Television is somewhat related to radio. But the difference between them is considerable—and important. You can't plunk a television set down anywhere and expect it to work efficiently. You can't slap up any old piece of wire in any position and use it for an antenna. You can't run any

kind of lead-in wire haphazardly from antenna to receiver. You can't do a lot of things in television because a television set is a sensitive, precision instrument. It must be focussed like an expensive camera. And many of the circuit adjustments are extremely delicate. The antenna system deals with extremely short radio waves, and the receiver relies upon the antenna system to provide television station signals *as strong as possible*.

Fig. 2. Relative merits of various dipole locations (Fig. 1) are observed at the television receiver in terms of best signal strength and picture quality. Telephone relays results to man on the roof.



To achieve this both the antenna and lead-in are actually *tuned!*

The receiver is also sensitive to noise or electrical interference. Television pictures can be seriously distorted by nearby operation of neon signs, diathermy machines, motors, and generators. But such interference can be minimized, often eliminated entirely, by proper installation of the antenna and lead-in.

The lead-in usually consists of "twin-lead ribbon"—two parallel wires spaced and encased by a flexible 1/2-inch plastic ribbon. The length of the lead-in isn't limited or critical, but the path of lead-in is very critical, and must avoid all pipes and large metal objects to minimize noise-interference pickup.

A fixed, horizontal dipole is used for television reception. Mounted on a wooden pole or framework, the antenna assembly is usually located at the highest part of the customer's house or building. However, the exact site of the receiving antenna is determined experimentally. Later, orientation and tuning of the *mounted* dipole is accomplished in the same manner.

Two technicians or installers are required to do the job. One man is located on the roof (Fig. 1) and one man is stationed at the receiver (Fig. 2). They communicate with each other by means of small, portable telephone sets. With a loose lead-in connecting the antenna and receiver, various roof positions of a movable dipole are judged at the receiver in terms of *signal strength and quality of the observed television picture*. In this manner, the best antenna site is located, and the dipole is oriented and tuned with extreme precision. This is the critical part of the installation procedure.

#### A Few Facts

A television channel is a wide band of extremely high radio frequencies, containing both sight (video) and sound (audio) signals. Programs from a television station are broadcast on an assigned channel, according to federal allocation. A television receiver must be tuned or switched to that specific channel in order to see and hear the televised programs. At present, the most popular television channels are in the group: Channel 1—44 to 50 mc.; Channel 2—54 to 60 mc.; Channel 3—60 to 66 mc.; Channel 4—66 to 72 mc.; Channel 5—76 to 82 mc.; Channel 6—82 to 88 mc. Seven other channels exist at even higher frequencies, between 172 and 216 megacycles, but the above six channels are more generally used for commercial broadcasting and reception.

Your line of television receivers can switch to most of these six popular channels. But within any area, your sales territory, *all* of these channels are never allocated by the government. Therefore, you are *only* concerned with the one, two, or possibly three assigned channels—the one, two, or possibly three television stations that can be received in your particular area!

September, 1947

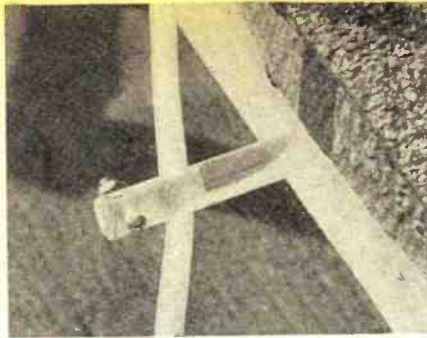

Fig. 3. Ideal lead-in for TV antenna is the "twin-lead ribbon." A polystyrene stand-off insulator is used.



Fig. 4. Two types of coaxial cables occasionally used for TV antenna lead-ins in noisy urban locations.

Because television is a short-range proposition, normal television reception is limited to 50 or 60 miles, due to the nature of the high-frequency waves. After leaving a station's transmitting antenna, they travel in straight lines. When they reach the horizon, they're lost for all practical purposes.

You can receive direct waves from a television station *only* if its transmitting antenna is visible, or "almost" visible, from the exact position of the receiving dipole. If the station's antenna can't be seen because of intervening buildings, or if the station's antenna is too far beyond the horizon, signals can't always be received. This explains the need for installing the receiving dipole as high as possible on the customer's house or building.

Most commercial types of television dipoles are premounted on four- or five-foot poles, which is a convenient height for most installations without guy wires. However, much higher framework or wooden towers can be used when it is necessary to raise the dipole above nearby houses or buildings obstructing the direct wave path of signals from a particular television station.

Before attempting any installation, you must know: 1. *Channel Numbers* of all television stations actively operating and normally heard in your area; 2. *Operating Schedule* of each station; 3. *Geographical Location* of the transmitting antenna of each station.

Assuming that three stations are operating at the same time and in the area of a television receiver equipped with an adequate antenna, *the three channels will not all be received with the same signal strength!* This is true because the air distance between each transmitting antenna and the receiv-

For Television Channel Number	Use Length (L) in inches
1	48.5
2	40.5
3	36
4	33
5	29
6	26.5
All 6	(mean) 37

Table 1. Proper length for 150 ohm matching section between 300 ohm lead-in and 72 ohm dipole for various television channels.

ing dipole will be different; the power transmitted on each television channel will be different; distant factors will influence the transmitted signals; and local factors will influence reception of the three signals.

Thus, the installation of a television antenna is considered adequate if a single dipole can pick up two, *and only two*, of three, four, or more operating channels in the area.

The channel best received is called the *Primary Channel*, the second best is called the *Secondary Channel*. During later installation of the antenna, the dipole can be oriented and tuned to favor the personal preference of the customer, as to his choice of *Primary and Secondary Channels*.

It's possible, of course, that three, four, or more channels may be received well in unusual circumstances, but installing a single antenna for "best reception" means that the *Primary Channel* is received extremely well or strong, the *Secondary Channel* good or fairly well, and the other channels faintly or not at all.

At the outset, this limitation of a single dipole must be accepted by the buyer. If he demands excellent reception of *all* stations in the area, a separate and independent dipole must be used for each station or channel, with some suitable switching device. Of

Fig. 5. Method of constructing and connecting matching section to 300 ohm lead-in. See Table I for proper value of length, L, of twin-lead section.

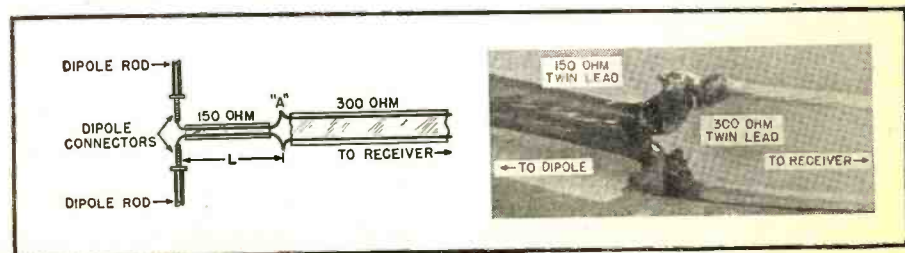

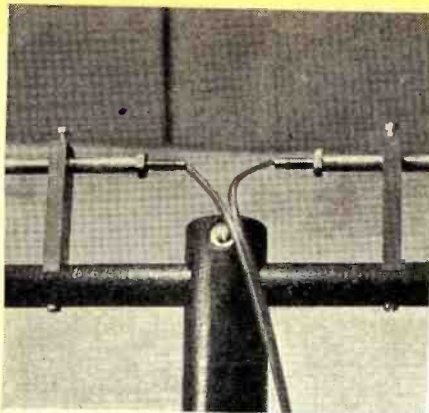

Fig. 6. Method of connecting matching section to center terminals of TV dipole.

For tuning antenna to Channel Number	Use Length for each rod, in inches
1	53.5
2	44.5
3	40
4	36
5	31.5
6	29.5
All 6	(mean) 41

Table 2. Length of each rod of dipole for tuning antenna to specific channels.

course the additional work would mean a much higher installation charge. The effectiveness of any television installation is proportional to its cost, with almost no limit.

#### Preparation

Prior to an installation, it's advisable to make a preliminary survey of the customer's house or building. Determine the customer's choice for *Primary Channel* and *Secondary Channel* reception. Establish the best interior

Fig. 7. Assembled dipole with lead-in and matching section attached ready for installation. Television technician shown is Jack McNally.



location for the television receiver, based on the following factors (in order of importance): 1. Preference of customer for location of set; 2. Viewing distance recommended by manufacturer for the particular set. (Small screens require 3 or 4 feet. Large screens require from 6 to 10 feet); 3. Absence of sunlight. (Excessively bright light on picture tube or screen will spoil contrast); 4. Remoteness from electrical apparatus in the house or building, to minimize or eliminate electrical interference.

When these factors have been determined note the distance from this location to the nearest *appropriate* window, skylight, air duct, or other means of access to the roof.

On the roof pick the most likely location for the receiving antenna, at a high but fairly accessible part of the roof, then estimate the approximate distance from the probable antenna location, via window, skylight, or air duct, to the established interior position of the receiver.

Armed with this preliminary information, you can then assemble parts and equipment for the installation procedure. You will need the following: 1. Sufficient length of lead-in, based on estimated distance from the roof to receiver plus about 50 feet. (Specifications; 300-ohm "twin-lead ribbon" transmission line similar to type K-1046, *Federal Telephone and Radio Corp.*); 2. About 4 feet of special lead-in for matching section, to be connected between regular lead-in and dipole antenna. (Specifications; 150-ohm "twin-lead ribbon" transmission line, similar to above); 3. Stand-off insulators, for mounting lead-in, estimate quantity from survey. (Specifications; Polystyrene with screw mounting); 4.

Fiber head nails for mounting lead-in, quantity as needed; 5. Commercial dipole antenna for television reception, with metal rods of suitable length, metal conductors, wooden supports and a four or five foot wooden mounting pole. (Specifications; Well-designed dipole providing adequate frequency discrimination and suitable directional properties with all tunable factors easily adjustable, similar to "Shur Television Antenna," *Shur-Antenna-Mount, Inc.*); 6. Heavy metal bracket for upright mounting of antenna pole on or against a vertical, slanting, or flat building surface. (Specifications; Must sustain weight of antenna without guy wires, must be sufficiently versatile to permit mounting on crest of roof, sloping sides or any horizontal or vertical surface, similar to "Adjustable Mount," *Shur-Antenna-Mount, Inc.*); 7. A small compass to locate direction of station transmitters on *Primary* and *Secondary* Channels; 8. A simple, two-wire, battery operated telephone system for two-way communications between roof and television receiver. (Specifications; Any inexpensive system, connecting wires must be covered and must be same length as 300-ohm lead-in); 9. Soldering iron, extra wire, nuts and bolts, tools, etc.; 10. Television receiver to be installed, shop-tested, and in good working order.

Two men—technicians, installers, or servicemen—are required for each complete television installation. Their work should progress strictly according to *Basic Procedure of Installation*.

There are four principal parts to the *Basic Procedure*: A. Locating the receiver; B. Preparing the lead-in; C. Siting the antenna; D. Orienting and tuning the antenna.

This *Basic Procedure of Installation* applies to all types of television receivers, without regard to make or model. It also applies to all types of single dipole antennas.

It's sufficiently general to cover all types of installations; remote houses, suburban residences, city dwellings, apartment houses, office buildings, and skyscrapers. In that order, however, the actual work becomes progressively more complex. Many of the details covering the more difficult types of installations will be considered in subsequent articles.

#### The Receiver

Handle the set carefully at all times, during delivery and during installation. Rough or improper handling often causes faulty operation of a set. Assemble the receiver, and place it in the desired location in the customer's home or office. Usually this position has been decided previously. The best location should be free of sunlight, allow sufficient viewing distance in front of the screen, and be sufficiently remote from electrical appliances. *But most important*, the final location must please the customer.

Place table models on strong, sturdy tables. Both table and console models require adequate ventilation. Don't

(Continued on page 156)

# NEW RADIO OUTLET Succeeds by Being Different

By  
**HARRY L. SPOONER**



**Carefully considered innovations are paying off for this dealer through increased sales and renewed customer acceptance.**

Increase your "listening capacity" by installing a record bar for your "pop" fans.

**B**EING different sometimes pays off—at least *Smith & Applegate*, Peoria radio, record, and appliance dealers, are finding it so.

When their record business boomed and listening booth space was at a premium they installed a novel record bar which their "pop" record fans have adopted enthusiastically.

The record bar is 9 feet long. The front is covered with padded leatherette while the top is of tile linoleum. Below the top are four turntables which run into a 15 watt amplifier. Each turntable is equipped with two sets of earphones thus making it possible for eight persons to listen to four records simultaneously. The listener can control the volume by means of a volume control located on top of the bar. The bar has more than paid for itself during rush periods in the store when the two listening booths are busy. Students from Peoria High School and Bradley University are the biggest boosters for this innovation.

Back of the bar, against the wall, is a back bar which carries the invitation "Record Bar—What's Your Listening Pleasure?" Below this unit is a display of albums and needles. This display has promoted the sale of record accessories to a gratifying level.

Although this up-to-date, promo-

tion-wise store is only a little over a year old, it is well-known in the community because the owners have dared to be different. Their advertising messages have blanketed the area through newspapers, direct mail, radio programs, and personal solicitation. Striking window displays and floor arrangements have backed this advertising to the hilt.

In spite of the fact that the store is only 62 x 175 feet, it boasts a full-fledged service department, both a heavy and traffic appliance department, a complete line of table and console radios, in addition to the ever-growing record department.

The two large display windows, which front on one of the main streets of Peoria, are made to pay off. Windows are changed every week—and residents of the city have come to expect something new, different, and attractive in the way of window displays. One of the windows is reserved for record promotion, the other is shared by the appliance and radio departments. Promotion tie-ins are utilized fully and visiting recording artists, bands, and soloists often come face-to-face with their pictures and records in *Smith & Applegate's* windows. These alert dealers know that

(Continued on page 165)

This uncluttered store layout permits *Smith & Applegate* to handle volume sales by directing traffic to related merchandising groups.

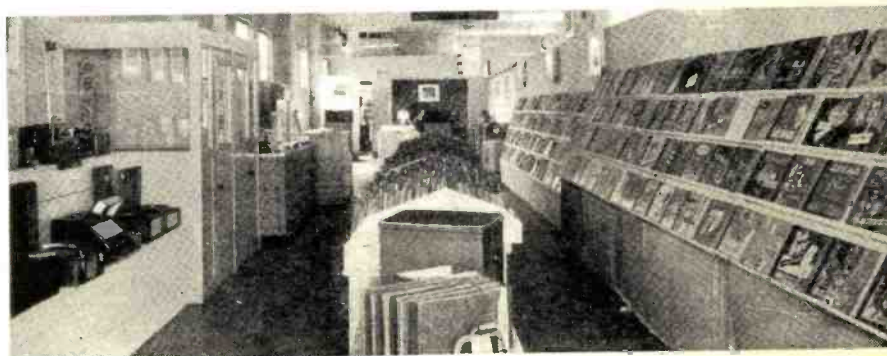

# A Practical VIBRATOR TESTER

By  
JOHN BOWLES

**This easy-to-build tester checks both output and starting voltages of vibrators and provides "Good?-Bad" analysis like conventional tube testers.**

**T**HERE has long been a need for a practical vibrator tester that tells the condition of a vibrator just as a tube tester indicates the performance of a tube. You can never feel quite sure that vibrator points are not worn to such a degree as to cause unsatisfactory service. While testing the tubes in an auto set it is also good practice to check the vibrator. Up to the present time there has been very little information as to how a vibrator could be quickly and accurately tested. As more autos

come on the market there will be an ever greater number of auto radios to repair. Therefore, it is more important than ever to have a good vibrator tester.

This article describes a practical unit which may be built easily at little expense, mostly from spare parts.

The circuit for this instrument was designed by P. R. Mallory & Co., Inc. This tester is not elaborate and does not require special tools or equipment to build. Likewise, it is very simple in principle and is easy to use.

Fig. 1. Schematic diagram of vibrator tester. Meter movements other than the 0-1 ma. specified may be used provided resistors  $R_2$  and  $R_3$  are changed accordingly.

Courtesy of P. R. Mallory & Co.

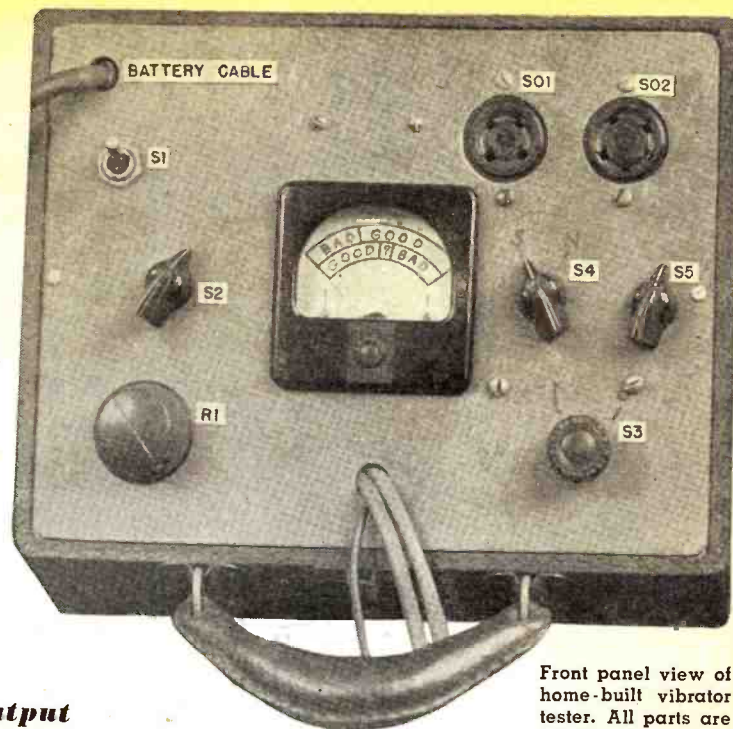
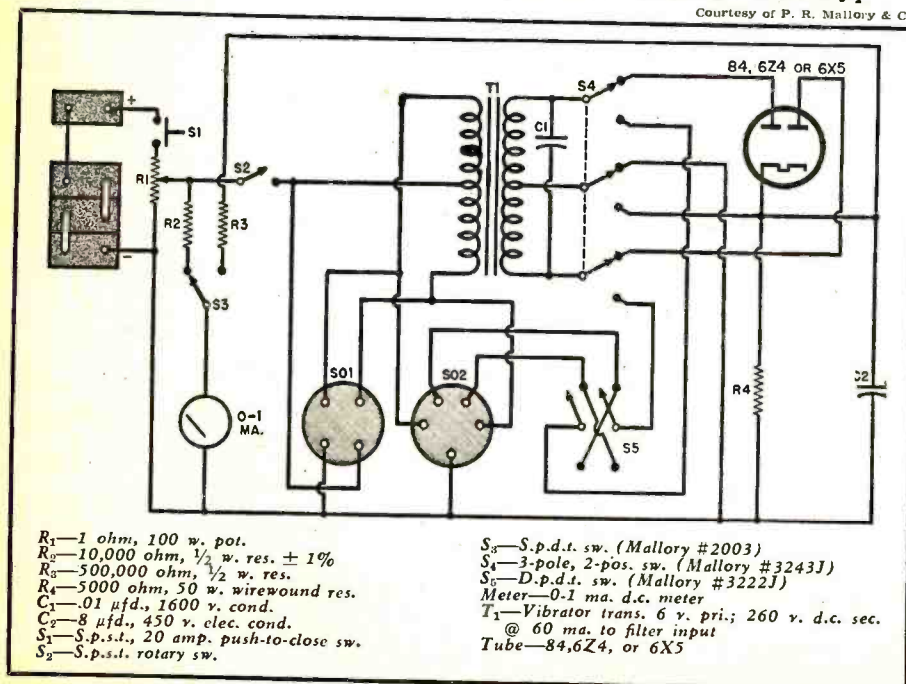

Front panel view of home-built vibrator tester. All parts are readily available.

The meter on the tester may be marked "GOOD," "DOUBTFUL," and "BAD." It is just as simple to use as a tube tester marked in the same manner.

With the best quality parts, the tester does not cost more than twenty-five dollars to build. It may be made from spare parts found in your "junk box" with correspondingly lower cost. It takes very little time to assemble the parts, and the wiring is not at all complicated. The time spent in building it, in the long run, saves much valuable time in servicing. The indications given by this tester are far more valuable than the characteristics of a vibrator found by checking with an oscillograph.

This vibrator tester determines the condition of a vibrator by checking its starting voltage. This indicates the quality of the vibrator on the basis of its starting characteristics just as a tube tester evaluates a tube from its cathode emission.

If the starting characteristics of a vibrator are good, a second check is provided which compares with the short test given a tube. This test is made by measuring the output voltage under load. A fairly constant, normal voltage indicates a good vibrator. If the output voltage is less than nine-tenths the normal voltage of a new vibrator of the same type or if it varies over a fairly wide range the vibrator should be discarded.

Vibrators passing both tests as indicated by this instrument may be used with confidence. Vibrators which are nearing the end of their lives are weeded out, thereby eliminating repeated trouble calls.

(Continued on page 146)



# A BANDSWITCHING V.F.O. EXCITER

By  
**CARL HAYS, WGRTP**

**No plug-in coils required — a novel  
bandswitching arrangement provides  
80, 40, 20, or 10 meter coverage.**

**I**F ALL those pieces of ham gear which the average amateur dreams about, perhaps none appears oftener in his "dream rig" than a completely self-contained exciter unit. The "dream" also includes a good, trouble-free variable frequency oscillator, frequency multipliers of reasonably husky output, link-coupling, of course, and over-sized power supplies—all of convenient size for table mounting.

Like everybody else, the author did little but dream about this exciter unit until finally this piece of equipment evolved from those dreams and became a reality.

In designing this equipment there were several important requirements which had to be met. 1. An extremely stable v.f.o. with no r.f. feedback "bugs." The note of the oscillator to be as good as crystal—the drift, due to design and tube choice, to be nil. 2. The unit must be capable of being switched to any one of four bands with no power on the multipliers when not in use. 3. Power output, even on ten, must be sufficient to double the grid mills reading heretofore obtained from a commercial e.c.o. and built-in doublers in the rig, to the 829-B final. 4. It must have quickly adjustable link-coupling on all bands. 5. The entire unit including power supplies must be self-contained in a single receiver-sized cabinet and should be arranged for integral push-to-talk operation. In addition to the above attributes the unit as it finally evolved makes a fine c.w. exciter by using fixed bias and inserting a closed circuit keying jack in the cathode of the 80 meter doubler. Other attractive features which were

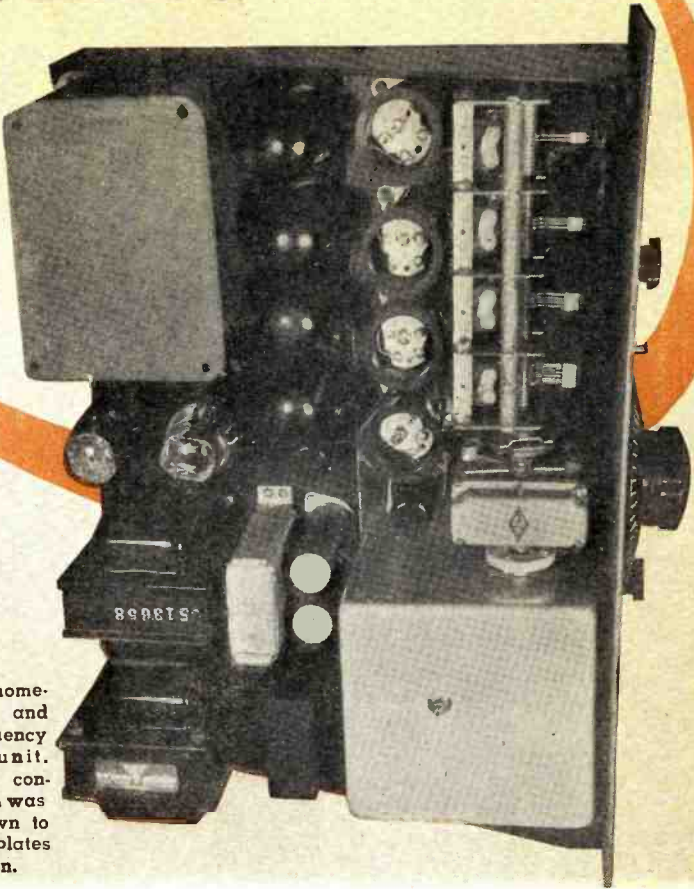

Top view of home-built exciter and variable frequency oscillator unit. Variable condenser shown was later cut down to two rotor plates per section.

incorporated in the final unit include grounded cathodes in all power stages and the use of two high-gain isolating "Class A" buffers. One useful item that contributes much to stability is the fact that the plate voltage is left on the oscillator and first "Class A" buffer during the time the unit is actually in operation. Very low oscillator voltage, plus real isolation and shielding, reduces the signal under standby conditions to such a low value that it cannot be heard once the unit is in the cabinet. With voltage on the two stages left on during receiving periods, the usual bugaboo of "warm up" is eliminated.

As can be seen from the diagram, the oscillator is somewhat unusual for this type of application as it is a fundamental, simple, and sure-fire tickler feedback Hartley. This circuit accomplishes several things advantageously, the most important being its absolute freedom from "hot cathode" ill effects, a feature not found in the electron coupled oscillator unless special precautions are taken since the cathode is grounded directly. Feedback adjustment is very simple, since all that is necessary is to subtract turns from a coil instead of fiddling with the critical cathode tap. This unit requires only fifty volts on the plate to perk nicely.

Several triodes were tried in this

particular circuit but the HY615 was chosen for several reasons; among them was its very small interelectrode capacity which, if capacity change with heat occurs, results in a very small change in net capacity across the tuned circuit. In this case, for instance, there is a total of nearly 700  $\mu\mu\text{fd.}$  in the tuning and fixed condenser combination to hit 160 meters. Thus it can be readily seen that if a capacity increase, with heat, of the HY615 elements does occur it must, of necessity, be a small percentage of the capacity used. In checking the *Handbook*, the interelement capacities of the HY615 will show that only a small change can occur in a tube having such small initial capacities.

The fact that the HY615 is expressly designed for oscillator use, that it will oscillate readily with very low voltage (and low heat), that its grid and plate caps are so located as to permit ideal physical layout, that it is a veritable powerhouse for its size, and that its filament draws such low current, serves to further emphasize the fitness of this tube in this application.

The next component which required special consideration was the oscillator coil. As has been pointed out many times before, bakelite is not a suitable material for an oscillator coil. The reason is simple as materials of this type have an unfavorable coefficient of

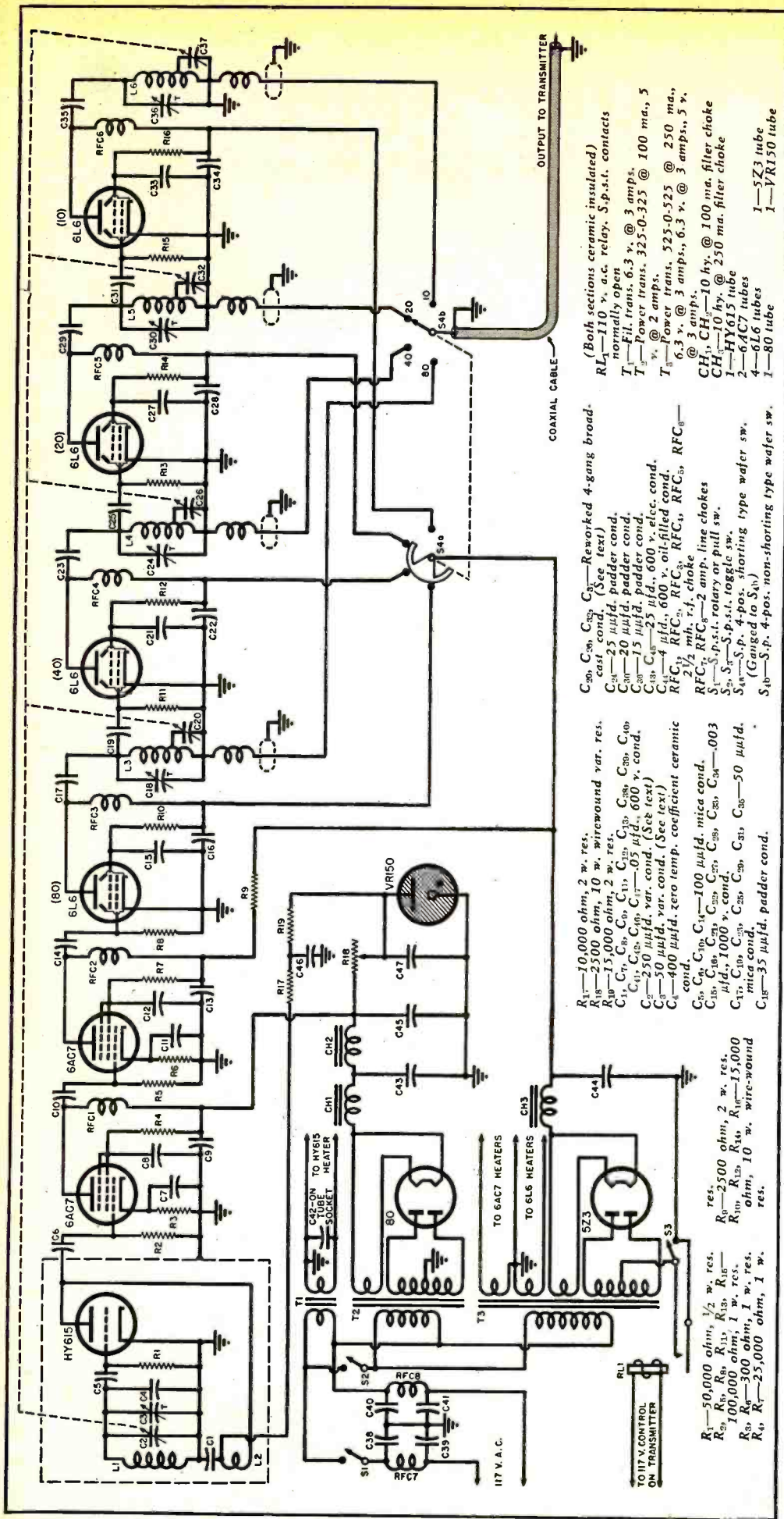

expansion. Porcelain, isolantite and steatite forms, preferably one of the last two named, have, by comparison, almost perfect reaction to heat. In addition they allow a much higher "Q" to be obtained, are much more rigid, and are impervious to moisture. The use of a coil wound on such a form (grooved if possible) is almost mandatory for a really satisfactory oscillator.

The type of wire used is also highly important. It should be #18 enamel covered, of the solid variety, spacing to be the diameter of the wire. Before the wire is put on the form it should be stretched as much as possible then the wire and form should be heated in the oven. Using gloves, the coil should be wound as tightly and as rapidly as possible. When it is necessary to solder any connections to this coil use just enough heat to make a good joint without allowing the wire to lose any tension. This method, although used for years, is still good for trouble-free inductance.

Padding capacity may be obtained by using zero coefficient type ceramic condensers mounted rigidly close to the coil and tube. A small (50  $\mu$ fd.) rigid midget plate condenser is used as a trimmer and is mounted in the same manner as the ceramic condensers. It is of utmost importance that the tuning condenser be of first quality. It should have ceramic end plates, be of the double bearing type and have rigid, well spaced plates and be of the straight-line-capacity type. It should be mounted immovably on a heavy L-shaped brackets front and rear. Be sure its rotor turns evenly but has a definite wiping contact to the ground lug. As an added precaution use one of the heavy, well-made, transmitting type flexible, ceramic-insulated shaft couplers to the dial drive unit.

This dial business is mighty important, for, to build a good oscillator and then try and tune it with a makeshift mechanism is the height of folly. One unit which is especially suited to the job is the National HRO-type. It is well built and has no backlash and, in addition, allows rigid, unyielding mounting to the heavy aluminum chassis

Complete schematic diagram of v.f.o.—exciter unit. All output voltages are obtained by means of link-coupling. The oscillator is a conventional Hartley circuit.

- CH<sub>1</sub>, CH<sub>2</sub>—10 hy., @ 100 ma. filter choke
- CH<sub>3</sub>—10 hy., @ 250 ma. filter choke
- 1—HY615 tube
- 2—6AC7 tubes
- 4—6L6 tubes
- 1—5Z3 tube
- 1—VR150 tube

- C<sub>30</sub>, C<sub>31</sub>, C<sub>32</sub>—Resonated 4-gang broad-cast cond. (See text)
- C<sub>33</sub>—20  $\mu$ fd. paddler cond.
- C<sub>34</sub>—20  $\mu$ fd. paddler cond.
- C<sub>35</sub>—10  $\mu$ fd. paddler cond.
- C<sub>36</sub>—250  $\mu$ fd. var. cond. (See text)
- C<sub>37</sub>—50  $\mu$ fd. var. cond. (See text)
- C<sub>38</sub>—400  $\mu$ fd. zero temp. coefficient ceramic cond.
- C<sub>39</sub>, C<sub>40</sub>, C<sub>41</sub>—100  $\mu$ fd. mica cond.
- C<sub>42</sub>, C<sub>43</sub>, C<sub>44</sub>, C<sub>45</sub>, C<sub>46</sub>, C<sub>47</sub>, C<sub>48</sub>, C<sub>49</sub>, C<sub>50</sub>—003  $\mu$ fd., 1000 v. cond.
- C<sub>51</sub>, C<sub>52</sub>, C<sub>53</sub>, C<sub>54</sub>, C<sub>55</sub>, C<sub>56</sub>, C<sub>57</sub>, C<sub>58</sub>, C<sub>59</sub>, C<sub>60</sub>—50  $\mu$ fd. mica cond.
- C<sub>61</sub>—35  $\mu$ fd. paddler cond.

- R<sub>1</sub>—50,000 ohms, 1/2 w. res.
- R<sub>2</sub>, R<sub>3</sub>, R<sub>4</sub>, R<sub>5</sub>, R<sub>6</sub>, R<sub>7</sub>, R<sub>8</sub>, R<sub>9</sub>, R<sub>10</sub>, R<sub>11</sub>, R<sub>12</sub>, R<sub>13</sub>, R<sub>14</sub>—100,000 ohms, 1 w. res.
- R<sub>15</sub>, R<sub>16</sub>, R<sub>17</sub>, R<sub>18</sub>, R<sub>19</sub>—15,000 ohms, 10 w. wire-wound
- R<sub>20</sub>, R<sub>21</sub>—25,000 ohms, 1 w. res.

- R<sub>22</sub>—10,000 ohm, 2 w. res.
- R<sub>23</sub>—2500 ohm, 2 w. res.
- C<sub>1</sub>, C<sub>2</sub>, C<sub>3</sub>, C<sub>4</sub>, C<sub>5</sub>, C<sub>6</sub>, C<sub>7</sub>, C<sub>8</sub>, C<sub>9</sub>, C<sub>10</sub>, C<sub>11</sub>, C<sub>12</sub>, C<sub>13</sub>, C<sub>14</sub>, C<sub>15</sub>, C<sub>16</sub>, C<sub>17</sub>, C<sub>18</sub>, C<sub>19</sub>, C<sub>20</sub>, C<sub>21</sub>, C<sub>22</sub>, C<sub>23</sub>, C<sub>24</sub>, C<sub>25</sub>, C<sub>26</sub>, C<sub>27</sub>, C<sub>28</sub>, C<sub>29</sub>, C<sub>30</sub>, C<sub>31</sub>, C<sub>32</sub>, C<sub>33</sub>, C<sub>34</sub>, C<sub>35</sub>, C<sub>36</sub>, C<sub>37</sub>, C<sub>38</sub>, C<sub>39</sub>, C<sub>40</sub>, C<sub>41</sub>, C<sub>42</sub>, C<sub>43</sub>, C<sub>44</sub>, C<sub>45</sub>, C<sub>46</sub>, C<sub>47</sub>, C<sub>48</sub>, C<sub>49</sub>, C<sub>50</sub>, C<sub>51</sub>, C<sub>52</sub>, C<sub>53</sub>, C<sub>54</sub>, C<sub>55</sub>, C<sub>56</sub>, C<sub>57</sub>, C<sub>58</sub>, C<sub>59</sub>, C<sub>60</sub>, C<sub>61</sub>
- L<sub>1</sub>, L<sub>2</sub>, L<sub>3</sub>, L<sub>4</sub>, L<sub>5</sub>, L<sub>6</sub>, L<sub>7</sub>, L<sub>8</sub>, L<sub>9</sub>, L<sub>10</sub>, L<sub>11</sub>, L<sub>12</sub>, L<sub>13</sub>, L<sub>14</sub>, L<sub>15</sub>, L<sub>16</sub>, L<sub>17</sub>, L<sub>18</sub>, L<sub>19</sub>, L<sub>20</sub>, L<sub>21</sub>, L<sub>22</sub>, L<sub>23</sub>, L<sub>24</sub>, L<sub>25</sub>, L<sub>26</sub>, L<sub>27</sub>, L<sub>28</sub>, L<sub>29</sub>, L<sub>30</sub>, L<sub>31</sub>, L<sub>32</sub>, L<sub>33</sub>, L<sub>34</sub>, L<sub>35</sub>, L<sub>36</sub>, L<sub>37</sub>, L<sub>38</sub>, L<sub>39</sub>, L<sub>40</sub>, L<sub>41</sub>, L<sub>42</sub>, L<sub>43</sub>, L<sub>44</sub>, L<sub>45</sub>, L<sub>46</sub>, L<sub>47</sub>, L<sub>48</sub>, L<sub>49</sub>, L<sub>50</sub>, L<sub>51</sub>, L<sub>52</sub>, L<sub>53</sub>, L<sub>54</sub>, L<sub>55</sub>, L<sub>56</sub>, L<sub>57</sub>, L<sub>58</sub>, L<sub>59</sub>, L<sub>60</sub>, L<sub>61</sub>

plate on which all oscillator components must be mounted. In addition the unit requires no fastening to the panel, an important point from the standpoint of mechanical stability, even when a solid  $\frac{1}{8}$ " heavily braced steel panel is used. On this particular unit the 80 meter band covers some 350 dial divisions which are approximately  $\frac{1}{4}$ " apart, on a circumference of about fifteen inches. This is equivalent to about nine or ten feet. It can readily be seen that no vernier scales or tricky wrist twisting are necessary to tune this exciter. In line with the coverage given for 80 meters, the unit covers some 100 divisions on 40 meters, 40 divisions on 20 meters, and 100 divisions on 10 meters.

In order to eliminate vibration in the unit, mount the oscillator and the first buffer stage on a sub-chassis of  $\frac{1}{4}$ " aluminum, spaced 1" above the main chassis by means of three rubber shock mounts yet leaving it free to float independent of any strain or shock reaching the chassis or panel. A hole, large enough to clear the shaft of the drive mechanism and located on the front panel, leaves the sub-chassis absolutely clear of any rigid connection—a requisite for stability from shock.

Circuit isolation from r.f. feedback, both internal and external, is shown in the photographs and diagram. Simple as it seems, it is highly important that such precautions be taken if trouble-free results are to be expected.

Shielding may be best accomplished by means of an aluminum or steel box which completely and rigidly encloses the oscillator section and is bolted to the sub-chassis. If desired, heat isolation can be improved by lining the inside of the box with a material such as  $\frac{3}{8}$ " masonite. This procedure, however, is merely an added refinement and is not necessary to the operation of the unit.

Voltage stabilization is provided by a dropping resistor following the VR150 tube and puts an even 50 volts on the HY615. The filament of the oscillator tube is left on continuously as it draws little current and this procedure reduces the warm-up period.

The two isolating, high-gain 1852 (6AC7) stages following are self-explanatory and the only precaution which must be taken is that the first stage following the oscillator should be mounted on the sub-chassis, and its grid connections should be made rigid to minimize load changes reaching the frequency determining circuit.

The four 6L6 stages which follow, each with its own tank permanently tuned to the output band desired, are conventional except for the use of grid leak bias only and the parallel feed plate circuits. These were used because it made the direct grounding of the rotor of the four-gang condenser simpler. This condenser is an inexpensive one of the broadcast variety, cut down to two rotor plates per section and tapped across enough of each coil to allow tracking.

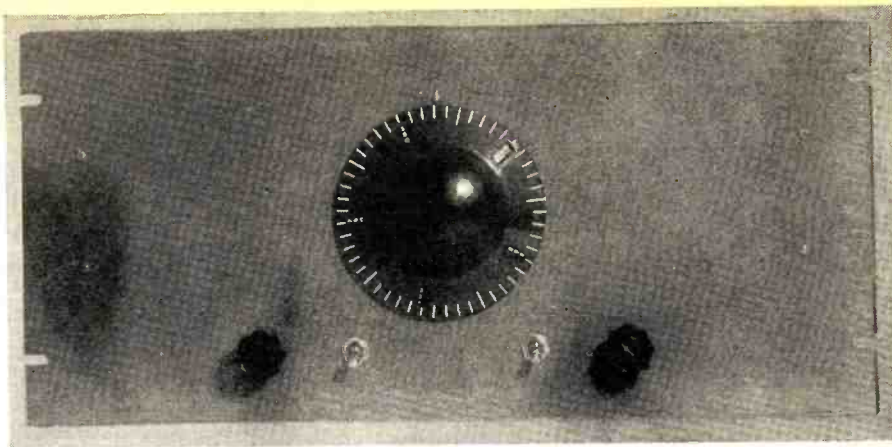

Single tuning control simplifies front panel layout. The controls from left to right are: oscillator filament switch, S<sub>1</sub>; oscillator plate and filament voltage switch, S<sub>2</sub>; doubler plate voltage switch, S<sub>3</sub>; and bandswitch, S<sub>4</sub>.

The switching circuit is a simple one. It allows only the stages in use to consume power. The switch is of the two section, ceramic wafer type and consists of a non-shorting section, single-pole, 4-position for the output links, ganged as a unit to a shorting type, single-pole, 4-position section. This type of switching allows any one of the four bands to obtain excitation by simply placing it in the proper position—no other adjustment is necessary.

The relay obtains 110 volt a.c. from the push-to-talk mike circuit switch in the transmitter proper and enables the operator to throw the exciter-transmitter on the air with one operation. A single-pole, single-throw toggle switch, paralleled with the contacts of the relay, enables the unit to be placed in operation by itself for adjustment or frequency spotting in the receiver.

Two power supplies are shown on the schematic. The one for the oscil-

L<sub>1</sub>—22 turns, #18 en., spaced wire diam., preferably on grooved ceramic  $\frac{1}{4}$ " diam. form.  
 L<sub>2</sub>—16 turns, #20 en. closewound  $\frac{1}{8}$ " below grid coil (L<sub>1</sub>). (See text for method of winding and mounting)  
 L<sub>3</sub>\*—38 t., #20 en., 2" long, tap 6 t.  
 L<sub>4</sub>\*—20 t., #20 en.,  $1\frac{1}{2}$ " long, tap 5 t.  
 L<sub>5</sub>\*—12 t., #20 en.,  $1\frac{1}{4}$ " long, tap 3 t.  
 L<sub>6</sub>\*—6 t., #20 en.,  $1\frac{1}{4}$ " long, tap  $1\frac{1}{2}$  t.  
 \* Wound on  $1\frac{1}{2}$ " receiver type forms. 5-prong with padder mount. Taps shown are only approximate. Adjustment is necessary so that proper tracking is obtained for your particular unit. Link winding for L<sub>3</sub> to be 6 turns; L<sub>4</sub> to be 4 turns; L<sub>5</sub> to be 3 turns; L<sub>6</sub> to be 3 turns. All link windings to be  $\frac{1}{8}$ " from cold end of coils. All link leads to be shielded to S<sub>4</sub>.

Construction details for coil assemblies.

lator and first "Class A" 1852 (6AC7) is one that was on hand—a husky 250 mil job using two sections, choke input, and 25  $\mu$ f. filters. (A transformer of 100 ma. rating would, however, handle the load). This means dependability plus, as well as excellent filtering. (Continued on page 183)

Under-chassis view of completed unit showing proper placement of parts.

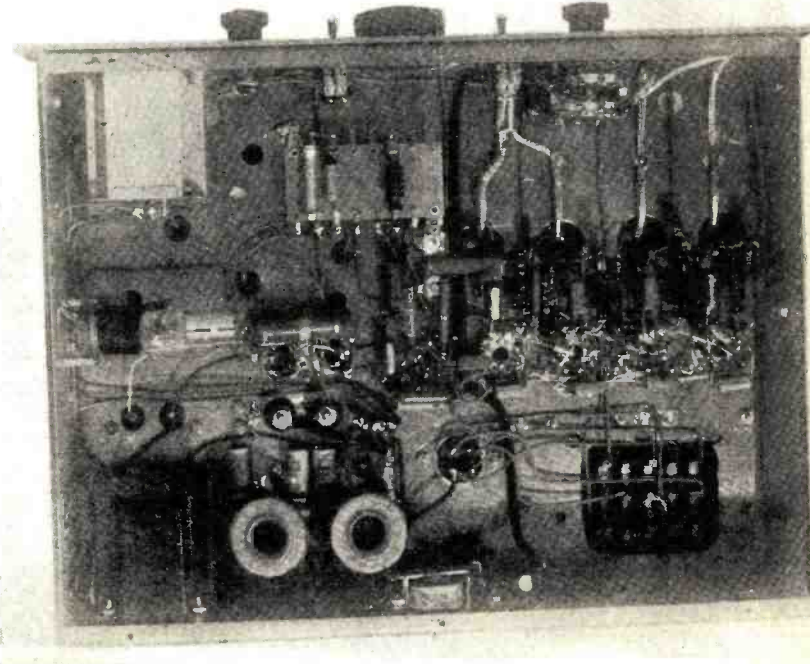

# TELEVISION COUNTERS

By  
EDWARD M. NOLL

## Theory of operation of several counter circuits used to produce horizontal and vertical sweep frequencies at the television transmitter.

**I**N THE sync generator of a television transmitter it is necessary to count down from the double line frequency of 31,500 to the field rate of 60 c.p.s. A block diagram of such a sync generator timing unit is shown in Fig. 2.

The basic timing circuit of the entire television system is a sine wave oscillator generally on 15,750 c.p.s. and, at times, on 31,500 c.p.s. In the generator of Fig. 2, the 15,750 cycle sine wave is doubled in frequency thus producing a 31,500 cycle sine wave. A 15,750 cycle output is taken from the timing unit at this point to synchronize all the horizontal circuits of the television system because the line repeti-

tion rate of the television system is 15,750 lines per second. The 31,500 cycle output excites a series of counter circuits which count down the double line frequency to the field frequency of 60 c.p.s. Therefore, the field timing is also a function of the basic 15,750 cycle oscillator. Two 60 cycle outputs are taken from the timing unit. One 60 cycle output synchronizes all the vertical deflection circuits of the television system while the second 60 cycle output is compared with the 60 cycles from the power line. If there is any phase displacement between the 60 cycle power line frequency and the final 60 cycle count down frequency, such as might occur when the basic timing oscillator departs from the correct frequency, a special discriminator circuit operates and restores the 15,750 cycle sine wave oscillator to its proper frequency. Consequently, the 15,750 cycle sine wave oscillator is the timing unit for the entire television system and is held precisely on frequency by proper comparison with the 60 cycles of the power mains.

The present commercial standard of television transmission is called the "odd-line interlaced system." This means that an odd number of lines are transmitted (525 lines per frame) and an even number of fields are transmitted. At the same time, the odd numbered lines are scanned in a first

field and the even numbered lines are scanned in a second field completing one frame or one complete picture. Because of this odd-line, even-field arrangement it is first necessary to double the frequency of the line or horizontal oscillator before it is possible to count down to the 60 cycle field rate. Actually, the only means by which it is mathematically possible to control the field rate with the line rate oscillator is to first double the frequency of the line oscillator and then use a series of odd counters to count down to the field rate. In most television sync generators a series of four counters is used with ratios of 7, 5, 5, and 3. The product of these four terms is 525 or the number of lines per frame.

### Principles of Operation

A number of these counters were constructed as a series of laboratory experiments in the television classes at Temple University. The first counter constructed was of the basic multivibrator type discussed by Fink in his book "Principles of Television Engineering." Upon observation of the RC time constants of both grid circuits, the multivibrator at first appears to be symmetrical. However, whenever the potentiometer in the grid section of the first section is not on maximum, the multivibrator becomes nonsymmetrical as it must be to operate as an odd-numbered counter. When the potentiometer is on maximum the multivibrator operates symmetrically. When the multivibrator is operated symmetrically the grid discharge and waveforms are identical. See Fig. 4. The output of the multivibrator is a pulsed waveform which appears across the cathode resistor of the second section.

Synchronizing signals from the preceding counter or oscillator are fed to both plates of the multivibrator and appear across the common plate resistor shown in Fig. 1. Consequently, both grids of the multivibrator are synchronized by synchronizing pulses or signals. Thus, if a series of negative sync pulses is applied to the multivibrator (as shown in Fig. 4) grid No. 1 is synchronized on the No. 5 pulse and grid No. 2 is synchronized on the No. 9 pulse. This, however, does not mean that the multivibrator is operating as a four-to-one counter because output is taken off of only one cathode circuit. Note that the only time any output is obtained is when the No. 1 pulse or the No. 9 pulse is synchronizing the second section of the multivibrator or driving the second section into conduction. Thus, the multivibrator is, in reality, an eight-to-one counter which is synchronized on every fourth pulse to improve stability. Inasmuch as the multivibrator must operate as an odd numbered counter it is necessary to reduce the time constant of the first section grid circuit. To do this, the resistance from the grid to ground of the first section is reduced with the potentiometer. The effects

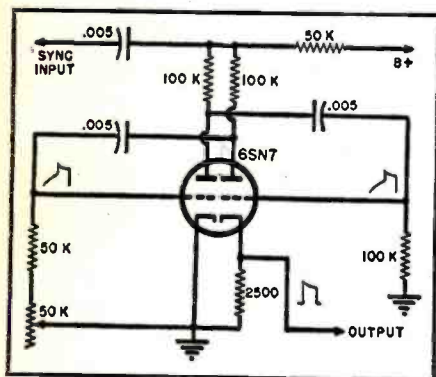
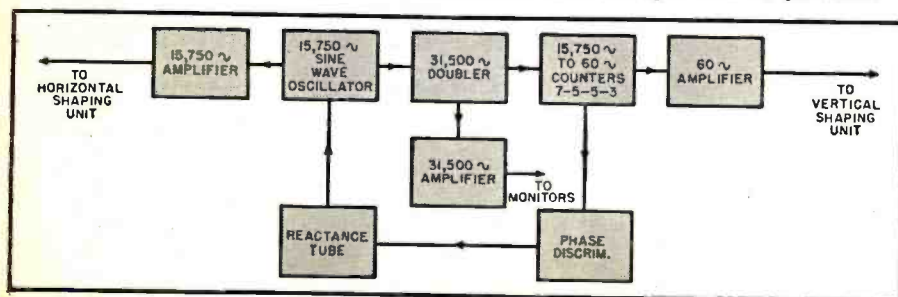

Fig. 1. Simple multivibrator counter.

Fig. 2. Simplified block diagram of timing unit for television synchronizing generator.



of the reduction in the grid time constant can be seen in the lower section of Fig. 4. Note that the first section synchronizes on the No. 4 pulse while the second section synchronizes on the No. 8 pulse. Again both grids are synchronized but the result is now a seven-to-one counter because the only time output is taken from the multivibrator is at the instant the first and eighth pulses drive the second section into conduction.

It is also possible to use sine waves as the driving signal for this counter. In the actual experiment a beat frequency audio oscillator was used as the source of driving signal. The multivibrator and frequency of the audio oscillator were adjusted until the first section grid synchronizes on the third sine wave while the second section grid synchronizes on the seventh sine wave to produce the waveforms indicated in Fig. 5. This type of counter occasionally jumps synchronism or counts when there are fluctuations in line voltage or changes in tube characteristics.

A more stable and more elaborate counter is shown in Fig. 3. This is a step counter and uses two diodes and two condensers to build up a step voltage on one of the condensers, which then triggers the multivibrator. The stepping counter consists of two charging diodes which step charge condenser  $C_2$ , a trigger tube which is driven into conduction when the amplitude of the step voltage reaches a certain level, and a screen grid multivibrator circuit which is triggered whenever the triggering tube is driven to conduction. When an incoming square or sine wave is applied to the charging diodes through condenser  $C_1$ , the positive going portion of the signal drives tube  $V_2$  to conduction. When diode  $V_2$  is conducting it causes a charge to appear across condenser  $C_2$ . The amplitude of this charge is a function of the capacity ratio of  $C_2$  to  $C_1$ . This ratio is usually twenty-to-one and consequently one-twentieth of the total voltage appears across  $C_2$ . On the negative sweep of the signal the second diode,  $V_1$ , conducts and the charge is completely removed from condenser  $C_1$ . This action of the diode  $V_1$  is similar to a d.c. restorer or clamp which returns the condenser to a no-charge level between pulses. During the negative part of the cycle however, diode  $V_2$  does not conduct and the charge remains on condenser  $C_2$  because it has no discharge path.

On the next positive alternation diode  $V_1$  cuts off and diode  $V_2$  conducts adding another charge or step to condenser  $C_2$ . Again, on the negative alternation diode  $V_1$  conducts and discharges  $C_1$  while the charge remains on condenser  $C_2$ . Thus, each new positive alternation adds a charge to condenser  $C_2$  building up the voltage in a series of steps (Fig. 7) until a voltage level is reached which has sufficient amplitude to overcome the trigger tube cathode bias causing it to conduct. It should be noted that each step

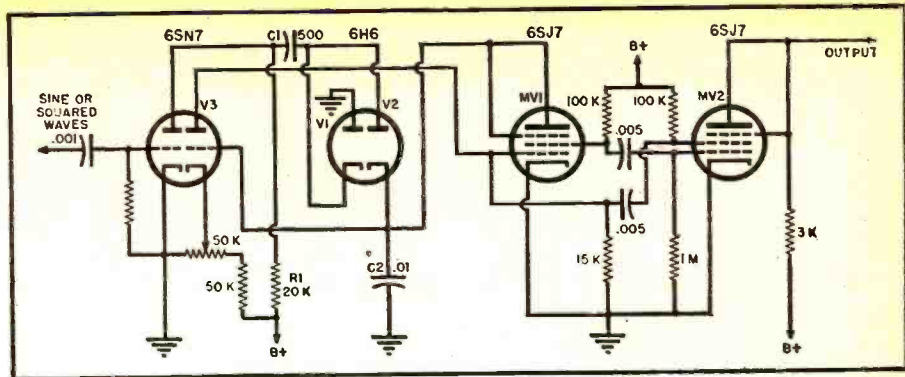

Fig. 3. Schematic diagram of multivibrator type step counter.

charge is of slightly less amplitude than the previous one because the charge condenser attempts to charge up to peak value of the applied pulse exponentially. Or, to consider this same condition in another way, the differential between peak pulse amplitude and condenser  $C_2$  charge level becomes progressively less as the charge builds up on  $C_2$ . Thus the voltage split between  $C_1$  and  $C_2$  is still the same but there is less voltage to be divided. This means that there is a practical limit to the steps or count that can be obtained because there is greater opportunity for instability and incorrect firing as the step levels approach each other in amplitude. A seven-to-one count is about the maximum which can be achieved when this type of counter is used for television.

When this step voltage reaches a sufficient level to cause the trigger tube to conduct, the drop in trigger tube plate voltage drops the screen grid (acts as the plate of the triode multivibrator) voltage of the first section and control grid voltage of the second section. This, in turn, raises the plate voltage of the second section and applies an amplified burst of voltage to the first section control grid which drives the first section into conduction each time the trigger tube conducts. Inasmuch as the tube only conducts when the voltage reaches the proper level, the circuit operates as a counter.

The time constant of the first section of the multivibrator is short in comparison to that of the second section, thus the second section conducts for a greater portion of the multivibrator cycle, the first section conduct-

*(Continued on page 166)*

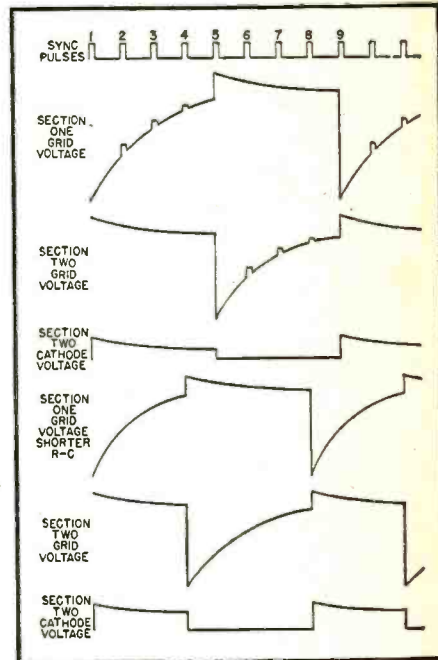

Fig. 4. Multivibrator waveforms.

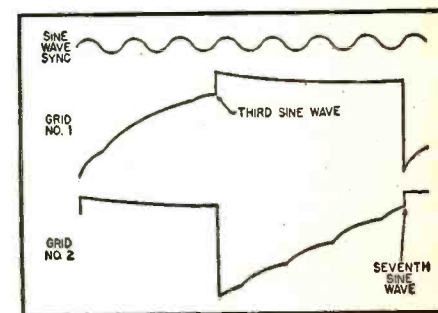
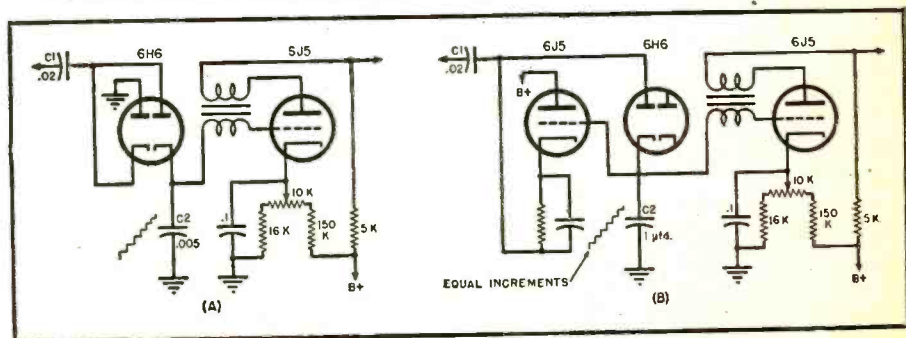

Fig. 5. Sine wave, from an audio oscillator, being used as the driving signal for counter.

Fig. 6 (A). Blocking tube counter. (B) blocking tube counter with equal voltage steps.



# Reflective Optical System for PROJECTION TELEVISION

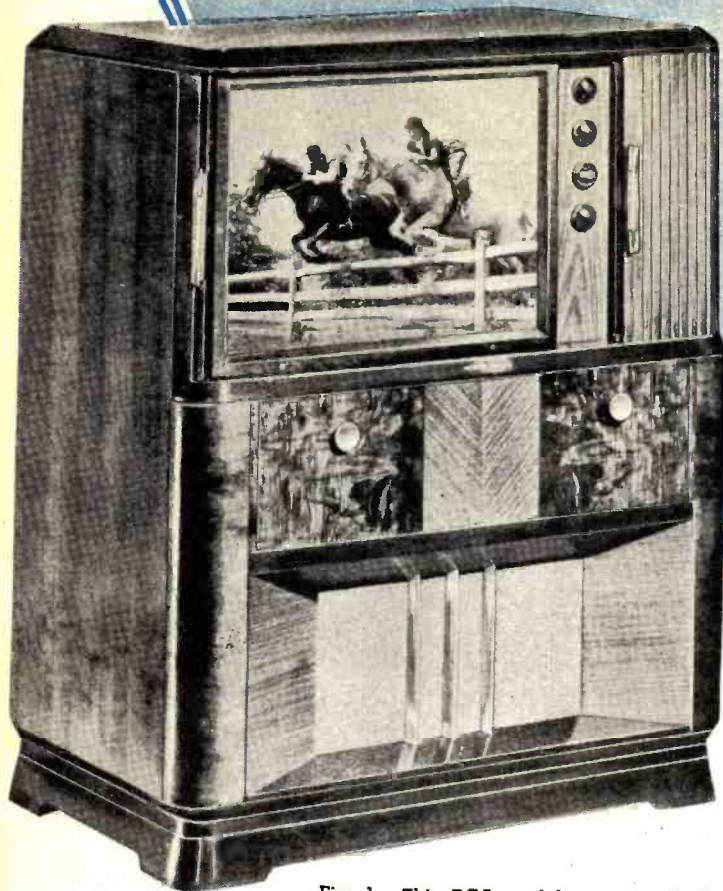

Fig. 1. This RCA model uses a reflective optical system with a 5TP4 kinescope to produce a final picture size of 15x20 inches.

By  
**Dr. V. K. Zworykin**

Vice-President and Technical Consultant,  
RCA Laboratories

*Few men have been more closely associated with the science of electron optics and the development of television than Dr. Vladimir K. Zworykin.*

*Inventor of the iconoscope, kinescope, and countless other electronic devices, Dr. Zworykin is an outstanding authority on television optics, cameras, and tubes.*

*He is responsible for the development of the Radio Corporation of America's all-electronic television system.*



## **Noted scientist describes new optical system for large screen television.**

**A**N IMPORTANT requirement of many of the larger types of modern television receivers is the projection of magnified picture images on a suitable, large observation screen.

This method of picture display is known as large-screen or projection television. It is an important and immediate step forward in television progress, since it is a simple and relatively inexpensive optical arrangement that provides enlargement and extension of picture images—for viewing at greater distances from the receiver without eyestrain, and for viewing by a greater number of people, than would otherwise be possible with a direct-viewing television set. Currently, there is a pronounced trend among many set buyers toward large-screen projection of television picture images.

Enlargement and projection of television pictures requires the use of a simple but highly effective optical

system, a special kinescope or picture tube, and minor considerations of cabinet design and optical adjustment. In operation, the final image is first formed on the screen of the picture tube and is then magnified optically and projected onto a large, upright viewing screen.

It was inevitable that research and development in the field of television reception eventually should encompass the science of optics—since television, itself, is a *visual* instrument with electron-optic components. However, only a few optical arrangements or systems can be used, because of the stringent requirements imposed by the nature of television projection.

The simplest, most effective, and efficient means of image projection is a system which employs optical reflection by means of a spherical mirror.

This reflective optical system can be adapted for use in home television receivers having *any* size of large

viewing screen. Also, it forms the basis for extremely large-screen projection used in theater television. *Basically*, the same optical system may be used for projecting chromatic television pictures.

### **Use of the System**

A typical home receiver equipped with large-screen television (Fig. 1) is the RCA projection-type television-radio console. The complement of 48 tubes in the complete set, which also provides AM, FM, and short-wave reception, includes a new type of picture tube—the type 5TP4—known as a projection kinescope.

The size of the final picture image on the large screen is roughly 15 inches by 20 inches, or about *six times* the size of the image on the face of the 5-inch picture tube. Focusing, magnification, and projection are accomplished by the reflective optical system consisting of a spherical reflecting mirror, an aspherical correct-

ing lens, and a plane mirror set at an angle of 45 degrees to direct the final image onto the viewing screen. This arrangement is shown in Fig. 4.

The enlarged, final image on the observation screen must be sufficiently bright for satisfactory viewing in a well-lighted room. Since all light elements are reflected onto the screen from the kinescope, the brightness of the final picture image is a function of the image brilliance on the face of the kinescope. Exceptional brilliancy is easily obtained, because the tube is especially designed for projection operation. The inside face of the tube screen is coated with an improved phosphor compound, and over this layer is placed a thin electron-transparent but light-reflecting metallic film which permits a high accelerating voltage for the electron beam. To achieve this, the second anode of the projection kinescope is operated with a potential of 27,000 volts, causing the extremely intense beam of electrons to strike the screen with great force—providing an image brilliance of great magnitude. All images appearing on the face of the kinescope are projected by the optical reflecting system to the back of the translucent, plastic, viewing screen.

The light-gathering ability of this optical system makes it possible to transfer to the viewing screen a high percentage of the image light produced on the face of the kinescope, whereas the efficiency of a conventional projection lens system in such an application is extremely low. A more complete understanding of the optical function of the basic reflecting system requires consideration of a few laws of the science of optics.

### About Optics

Light is a form of radiation. Light waves or rays are similar to radio waves, except that the frequencies of light are very much higher and confined to a narrow band of frequencies. The eye can detect or see light waves within this narrow band, but is unaffected by higher or lower frequencies.

Also similar to short radio waves, light rays are propagated in straight lines—and their paths depend only on their point of origin and initial direction.

A ray of light *incident* on a mirror is *reflected* at the same angle with the surface as the incident ray. A ray of light passing through a transparent medium (such as glass or clear plastic) is *refracted* or deflected obliquely from its path according to the nature (the refractive index) of the medium. A light ray is said to be reflected when it is sent back into the medium (air, glass, etc.) from which it came. However, no surface obtainable reflects all of the light rays falling upon it. Highly polished silver has a reflectivity of about 91 per-cent, aluminum about 88 per-cent, and gold about 70 per-cent; these are a few of the best reflecting surfaces.

One important *shape* of reflecting surface is a concave *spherical mirror*, shown in cross section (Fig. 2), and having a highly reflective metallic coating on the inner surface. The segment *AOB* is the arc of a circle, of which the center *C* is known as the *center of curvature*. The chord *AB* is the *aperture* of the mirror. The distance *DO* is the *focal length* of the spherical mirror, and is equal to half the radius of the curvature of the sphere. The point *D* is known as the *principal focus*.

If a point source of light is located at the principal focus of a spherical mirror having a relatively small aperture (Fig. 2), all light rays incident on the mirror surface will be reflected in directions parallel to the principal axis of the mirror. Any *object* located on the principal axis between the center of curvature *C* and the principal focus *D* will be reflected by the mirror as an enlarged, inverted *image*.

Use of a spherical mirror with a large aperture produces poor focusing and resulting distortion. If a small, limiting aperture is located at the center of curvature *C*, the focusing action of the system is very good, except that a flat object is reflected as a curved image. To obtain a flat image (or image which can be viewed on a flat screen, without distortion), it is necessary to use a curved object, such as the face of a cathode ray tube. The radius of the object is about equal to one-half the radius *CO* of the reflecting mirror, so that portions of the two spheres facing each other will be approximately concentric. This arrangement is shown in cross section in Fig. 5.

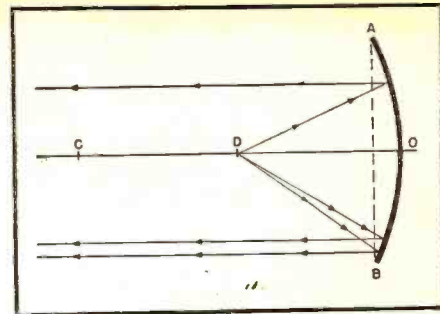

Fig. 2. Reflection of light from a point source by a simple spherical mirror.

Light rays originating from any point on the surface of the object (the face of the picture tube) are reflected by the spherical mirror, and then converge at various focus points, all of which lie in a plane at right angles to the principal axis of the system. This plane surface represents the observation or viewing screen. When a picture image appears on the fluorescent screen or face of the picture tube, it is reflected and focused by the spherical mirror (Fig. 5) so that the image appears greatly enlarged and inverted on the large plane surface of the viewing screen.

Trace this optical action in terms of individual light rays, referring to Fig. 5. Light rays 1 and 4 represent the approximate limits of both kinescope and final-screen image, in the plane of the drawing. Ray 2 contributes a small amount of light to another part of the reflected image. Ray 3 originates at the center of the kinescope fluorescent screen and by optical reflection reaches the center of the plastic observation screen. Countless

Fig. 3. Projector for theater television with control console in the background.



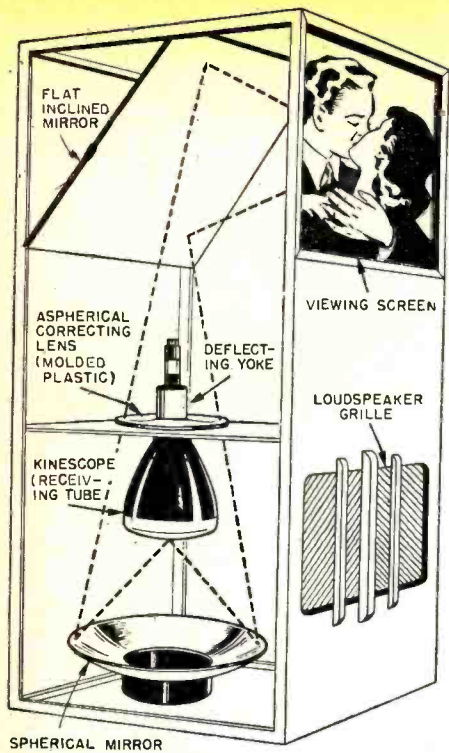
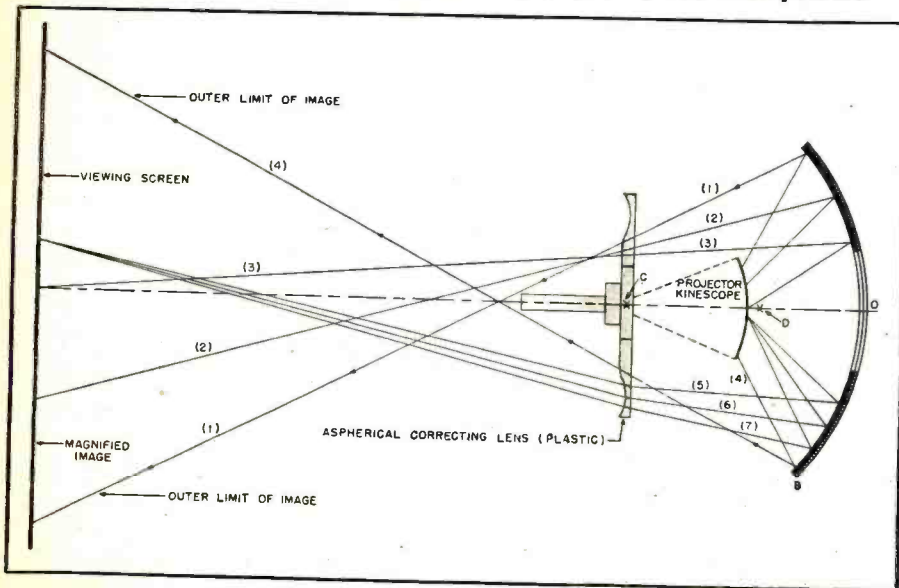

Fig. 4. Large screen television for the home provides bright, high definition pictures on a screen 20x15 inches by means of a reflective optical system.

other rays follow other paths, reaching the viewing screen at points proportionally located with respect to points of origin (the kinescope face). The total or combined effect of all light rays emanating from the picture tube produces a complete, enlarged, and inverted image of the original object.

Considerable improvement in the efficiency of an optical system can be accomplished by enlarging the size of the limiting aperture. An enlargement of the aperture, however, produces a distorted and poorly defined picture image. This is caused by the

Fig. 5. Optical reflection of light from a television picture tube by a spherical mirror and a correcting lens. The image appears greatly enlarged on viewing screen.



spherical aberration of the reflecting mirror, known as a characteristic error of the optical component.

### Aberration

The effect of spherical aberration is uniform over the entire projected field of the image; it is present at the edges as well as the center of the picture image on the viewing screen.

This error is inherent in the mirror itself. Since the nature of the error is known, it may be counteracted or eliminated entirely by introducing into the optical system another optical component—such as a lens—having the opposite error. In this way, one lens or mirror complements the other. Light rays pass through both optical components, and the final image is effectively free of distortion.

An aspherical correcting lens is introduced to the optical system, for this reason. It compensates for natural errors of the spherical mirror, thus insuring clear and well-defined picture images on the final viewing screen.

Typical use of the correcting lens is shown in Fig. 5. Size of the lens is large in order to increase the efficiency of the system and to provide good picture definition. The lens is very weak, and located at the center of curvature of the mirror so that the symmetry of the optical system is least disturbed.

Shape of the lens is important, since it controls the amount and type of correction. The shape is such that all light rays emanating from any point on the inner face of the kinescope will, after reflection, be optically forced to converge at a single point on the viewing screen. This action is illustrated in Fig. 5 by light rays 5, 6, and 7, all of which originate at the same point on the face of the picture tube, take different paths during reflection, but converge at a point on the viewing screen due to the correcting action of the aspherical lens.

Preparing and polishing a glass correcting lens of such unusual shape would be difficult, costly, and time consuming. This difficult problem of construction has been overcome, however, by processing the lens from heated plastic formed in precision molds while under high pressure. Optical properties of plastic are superior to glass and, in addition, there is considerably less scattering and even higher transmission of light rays.

Production-line manufacture of these lenses is so precise that no polishing, surfacing, or finishing is required before insertion in the reflective optical system.

Although reflecting mirrors are easily manufactured of glass because of their simple shape, future mirrors probably will also be constructed of molded plastic.

### The Picture Tube

A special type of projection kinescope has been developed for use in this and all similar reflective optical systems for large-screen television.

To provide sufficient light for reflection, the picture tube is required to operate with extreme brilliancy which, in turn, requires a high acceleration voltage for the electron beam.

During development, the use of a high potential was found incompatible with other essential factors, until several problems were solved.

One such problem was the effect of high-voltage electron bombardment on the phosphors used to coat the fluorescent screen of the kinescope. It proved necessary to place a thin, metallic film over the phosphor compound, permitting the luminescent material to give long and stable service under greater electron bombardment. The important technique of coating the phosphor layer with a thin, electron-transparent, light-reflecting, metallic film (usually aluminum) permits much higher operating voltages than were formerly possible. The metallic film acts somewhat as a mirror, preventing loss of light within the tube. This important technique considerably enhances the brightness and the contrast of the screen image of the kinescope.

Another development problem was the tendency of high voltages to cause a potential breakdown between electrodes within the picture tube. This was overcome by increasing the space between adjacent electrodes, by evacuating the tube to a very high vacuum before sealing, and by polishing all parts and protuberances which might serve as terminals for potential current arcs.

There was also the problem of reconciling high current with a sharp focus for the electron beam, since the difficulty of obtaining a good focus increases rapidly with an increase in current. This problem was overcome by improvements in the design of the electron gun used in the kinescope.

(Continued on page 153)



# Designing a 2 METER COMMUNICATION RECEIVER

By  
**ROBERT B. TOMER, W1P1M**

Chief Eng., Symphonic Radio &  
Electronic Co.

**S**OME time in the early part of last year the QRM situation on 2 meters in the Greater Boston area became so bad on occasions that there was nothing to do but pull the switch and go to bed. Particularly was this the case during one of those evenings when the second and third district stations were being heard and everybody was either listening or calling on their frequencies. The receiver in use at that time was a typical 955 superregen which had been carefully designed and improved until very little more could be expected from it, yet it left much to be desired. It was, of course, noisy like all members of the superregen family. In addition, one or two local stations or receivers would just about completely block the whole band and make any further operation impossible. The receiver had plenty of sensitivity and aided by a six element beam, there wasn't much that it wouldn't hear, provided no other locals were on or listening at the same time.

The obvious answer was to attempt to design some sort of receiver that would overcome the weaknesses inherent in the superregen and at the same time sacrifice none of the sensitivity. To design such a receiver is no small undertaking because the sensitivity of the superregen detector is little short of miraculous. Almost any homemade receiver of this type will have a sensitivity of 1 microvolt and a good one can easily measure .25 microvolt. When one considers the fact that a good broadcast receiver with six or eight tubes will seldom measure better than 25 microvolts and the better grade of communications receivers rarely go below 1 microvolt with up to twelve tubes, the problem of building a receiver for 144-148 megacycles with a sensitivity of better than .25 microvolt becomes all too apparent.

It appeared that either a combina-

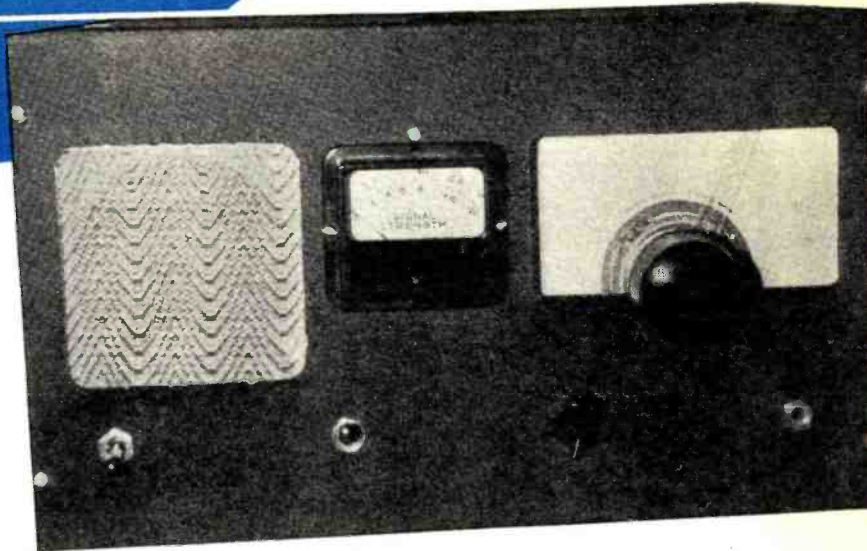

Front panel view of home-built receiver.

***This 144-148 mc. superheterodyne features good selectivity, an "S" meter, and noise limiter.***

tion superhet-superregen or a multi-tube superhet would be required to do the job. The former system seemed the simplest answer and so a set was built using a single tube, a 6J6, as the oscillator and mixer and this worked directly into the superregen second detector on 12 megacycles. This arrangement proved very difficult to handle due to interaction between the oscillator and mixer circuits in the same tube. "Pulling" of one circuit by the other made tracking impossible. Reducing the oscillator amplitude to a point just before it stalled seemed to help reduce the pulling and permitted some degree of tracking, however, the sensitivity was poor compared to the original superregen and so the idea was discarded. A separate oscillator and mixer tube was next tried, using a 9001 as mixer and a 9002 as oscillator. In addition, one stage of i.f. amplification was added ahead of the second detector using a 6AC7. This arrangement showed real progress. Tracking and ganging became quite simple and stable, the addition of the i.f. stage brought the gain up considerably and the action of the second detector seemed to become smoother. Considerable difficulty was encountered coupling the plate of the 6AC7 to the grid circuit of the superregen detector. Inductive coupling was tried first, using a tuned plate circuit coupled to the tuned grid circuit. It was found, however, that when the plate circuit was brought to resonance with the grid circuit the detector

would go out of superregeneration. Decoupling was attempted, but it turned out that when the coils were sufficiently decoupled to prevent blocking of the detector there was insufficient coupling to provide any signal. Many different types of i.f. transformers were made and tried, but all had the same difficulty. Finally, choke and capacity coupling were resorted to which sacrificed some gain and selectivity, but otherwise worked very satisfactorily. The receiver as a whole, however, did not measure up well in comparison with the old superregen and so an r.f. stage was added ahead of the mixer stage. Getting this to work correctly was a project in itself, but more about that later. The addition of the r.f. stage accomplished something, but it was still not a good enough receiver to have warranted the time and effort thus far spent on it. Another stage of i.f. was decided upon, using another 6AC7 and subsequently it was built into the receiver. With the addition of this extra stage, the gain of the receiver went way up, but at the same time, the noise level seemed to rise disproportionately. A good deal of thought and study went into trying to find the cause for this increase in signal-to-noise ratio and the explanation seemed to be as follows.

Whenever an amplifier is placed ahead of a superregen detector operating at the same frequency as that of the detector, this condition seems to become apparent. It is well known

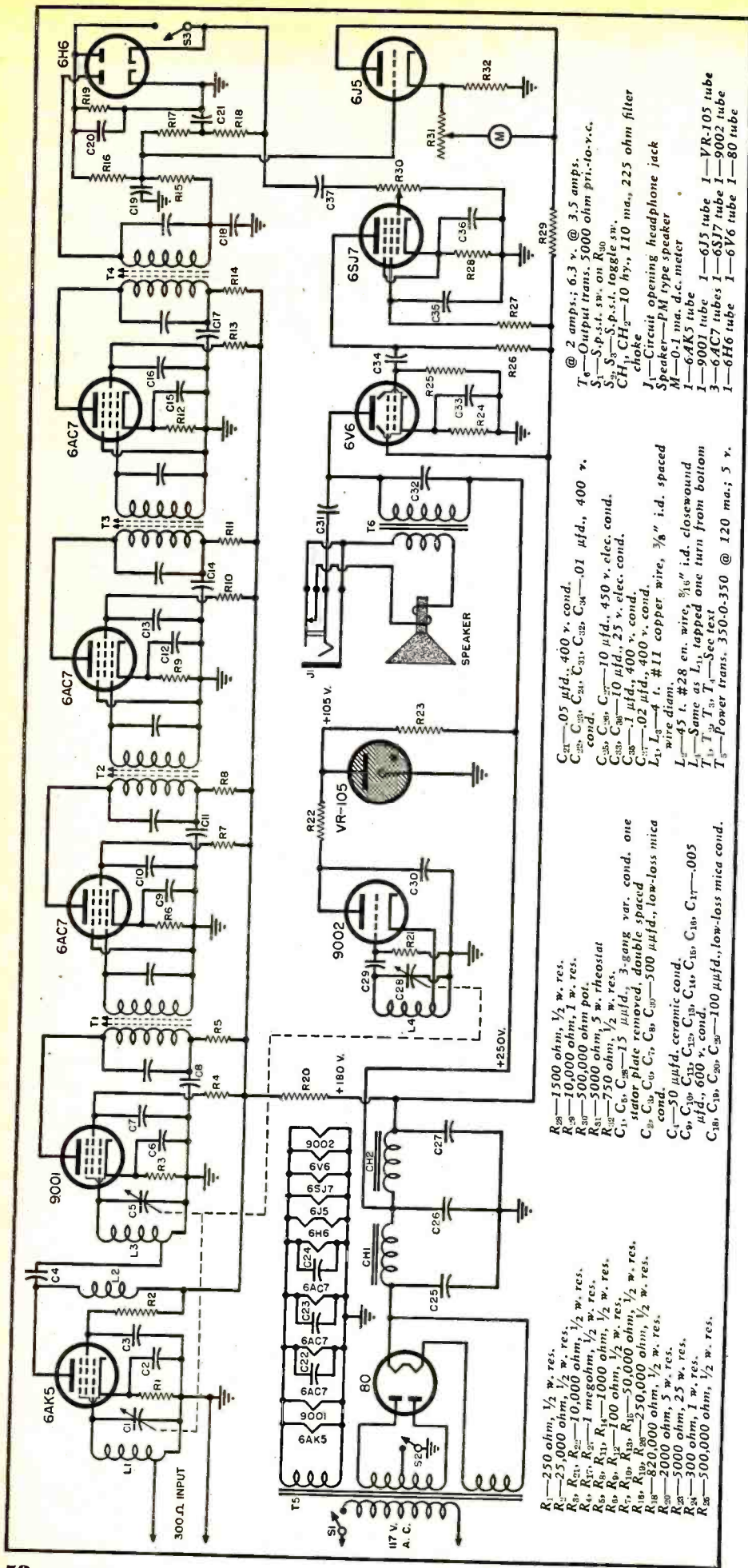

that the superregen detector radiates a signal which is modulated by the quench frequency but it seems not to be so well established that it is also modulated by the characteristic rushing sound which comes out of the speaker of such a receiver. As a matter of fact, it also seems to be modulated by any other signal that happens to be present in its grid circuit at the time. Thus, it can re-radiate the same signal to which it is tuned, on many different frequencies, all close to its own fundamental. This effect is very noticeable on a superhet with a diode second detector. When a superregen receiver is tuned across its frequency, a loud hissing sound will come from the superhet. This noise is exactly the same as that normally coming from the superregen receiver. In addition, if you happen to be located near to one of those powerful radiating detectors, such as an HY-615, you will be able to tell what station they are receiving by simply tuning across the band until you hear the hissing sound, and then, by tuning around in the hiss, you will find the same signal at what seems to be several different frequencies over an area of perhaps one half a megacycle. This is evidence enough that both the noise and the signal do radiate from the detector. It is logical to assume, therefore, that a portion of this radiation can re-enter the amplifier stage and be fed through again, perhaps out-of-phase, so that it is presented to the detector again as any other signal would be. It is also recognized that the superregen detector sensitivity goes down under signal input and that a sort of a.v.c. action takes place. Consequently, the result of receiving a portion of its own hash is that the detector sensitivity drops off and the noise, which is really the modulation on the signal being received, gets louder.

To prove the correctness of this theory, the second detector was completely shielded in a separate box under the chassis. All leads entering this box were completely filtered so that no energy could radiate from the detector. This device made a great improvement in the receiver. The noise level went down to where it should have been and the stability of the i.f. system improved at the same time. The resulting receiver was beginning to act like a pretty good set. The gain was somewhat better than the original receiver, selectivity was very much better, but the noise was still rather high and the quality of the second detector was not all that could be desired. In the course of experiments with the second de-

Schematic diagram of complete 12-tube (including rectifier and voltage regulator tubes) receiver. The circuit is straightforward with the exception of the oscillator stage. Note that there is no direct coupling between the oscillator and mixer stages. Inductive coupling is depended upon for injection of oscillator voltage. Placement of component parts is semi-critical. The author's original layout should be followed as closely as possible in order to duplicate performance.

- R<sub>1</sub>—250 ohm, 1/2 w. res.
- R<sub>2</sub>—25,000 ohm, 1/2 w. res.
- R<sub>3</sub>—10,000 ohm, 1/2 w. res.
- R<sub>4</sub>—500,000 ohm pot.
- R<sub>5</sub>—3000 ohm, 1 w. res.
- R<sub>6</sub>—5000 ohm, 1 w. res.
- R<sub>7</sub>—750 ohm, 1/2 w. res.
- R<sub>8</sub>—15 ohm, 1/2 w. res.
- R<sub>9</sub>—15 ohm, 1/2 w. res.
- R<sub>10</sub>—3-gang var. cond. one stator, plate removed, double spaced cond.
- R<sub>11</sub>—0.1 μfd, 400 v. cond.
- R<sub>12</sub>—0.1 μfd, 400 v. cond.
- R<sub>13</sub>—4 ft. #11 copper wire, 3/8" i.d. spaced
- R<sub>14</sub>—45 ft. #28 en. wire, 3/16" i.d. closewound
- R<sub>15</sub>—5 ft. #11 copper wire, 3/16" i.d. closewound
- R<sub>16</sub>—10 ft. #11 copper wire, 3/16" i.d. closewound
- R<sub>17</sub>—10 ft. #11 copper wire, 3/16" i.d. closewound
- R<sub>18</sub>—10 ft. #11 copper wire, 3/16" i.d. closewound
- R<sub>19</sub>—10 ft. #11 copper wire, 3/16" i.d. closewound
- R<sub>20</sub>—10 ft. #11 copper wire, 3/16" i.d. closewound
- R<sub>21</sub>—10 ft. #11 copper wire, 3/16" i.d. closewound
- R<sub>22</sub>—10 ft. #11 copper wire, 3/16" i.d. closewound
- R<sub>23</sub>—10 ft. #11 copper wire, 3/16" i.d. closewound
- R<sub>24</sub>—10 ft. #11 copper wire, 3/16" i.d. closewound
- R<sub>25</sub>—10 ft. #11 copper wire, 3/16" i.d. closewound
- R<sub>26</sub>—10 ft. #11 copper wire, 3/16" i.d. closewound
- R<sub>27</sub>—10 ft. #11 copper wire, 3/16" i.d. closewound
- R<sub>28</sub>—10 ft. #11 copper wire, 3/16" i.d. closewound
- R<sub>29</sub>—10 ft. #11 copper wire, 3/16" i.d. closewound
- R<sub>30</sub>—10 ft. #11 copper wire, 3/16" i.d. closewound
- R<sub>31</sub>—10 ft. #11 copper wire, 3/16" i.d. closewound
- R<sub>32</sub>—10 ft. #11 copper wire, 3/16" i.d. closewound
- C<sub>1</sub>—0.05 μfd, 400 v. cond.
- C<sub>2</sub>—0.05 μfd, 400 v. cond.
- C<sub>3</sub>—0.05 μfd, 400 v. cond.
- C<sub>4</sub>—0.05 μfd, 400 v. cond.
- C<sub>5</sub>—0.05 μfd, 400 v. cond.
- C<sub>6</sub>—0.05 μfd, 400 v. cond.
- C<sub>7</sub>—0.05 μfd, 400 v. cond.
- C<sub>8</sub>—0.05 μfd, 400 v. cond.
- C<sub>9</sub>—0.05 μfd, 400 v. cond.
- C<sub>10</sub>—0.05 μfd, 400 v. cond.
- C<sub>11</sub>—0.05 μfd, 400 v. cond.
- C<sub>12</sub>—0.05 μfd, 400 v. cond.
- C<sub>13</sub>—0.05 μfd, 400 v. cond.
- C<sub>14</sub>—0.05 μfd, 400 v. cond.
- C<sub>15</sub>—0.05 μfd, 400 v. cond.
- C<sub>16</sub>—0.05 μfd, 400 v. cond.
- C<sub>17</sub>—0.05 μfd, 400 v. cond.
- C<sub>18</sub>—0.05 μfd, 400 v. cond.
- C<sub>19</sub>—0.05 μfd, 400 v. cond.
- C<sub>20</sub>—0.05 μfd, 400 v. cond.
- C<sub>21</sub>—0.05 μfd, 400 v. cond.
- C<sub>22</sub>—0.05 μfd, 400 v. cond.
- C<sub>23</sub>—0.05 μfd, 400 v. cond.
- C<sub>24</sub>—0.05 μfd, 400 v. cond.
- C<sub>25</sub>—0.05 μfd, 400 v. cond.
- C<sub>26</sub>—0.05 μfd, 400 v. cond.
- C<sub>27</sub>—0.05 μfd, 400 v. cond.
- C<sub>28</sub>—0.05 μfd, 400 v. cond.
- C<sub>29</sub>—0.05 μfd, 400 v. cond.
- C<sub>30</sub>—0.05 μfd, 400 v. cond.
- C<sub>31</sub>—0.05 μfd, 400 v. cond.
- C<sub>32</sub>—0.05 μfd, 400 v. cond.
- T<sub>1</sub>—1000 tube
- T<sub>2</sub>—6A4K5 tube
- T<sub>3</sub>—6AC7 tubes
- T<sub>4</sub>—6H6 tube
- T<sub>5</sub>—6J5 tube
- T<sub>6</sub>—6SJ7 tube
- T<sub>7</sub>—6V6 tube
- T<sub>8</sub>—6J5 tube
- T<sub>9</sub>—6J5 tube
- T<sub>10</sub>—6J5 tube
- T<sub>11</sub>—6J5 tube
- T<sub>12</sub>—6J5 tube
- T<sub>13</sub>—6J5 tube
- T<sub>14</sub>—6J5 tube
- T<sub>15</sub>—6J5 tube
- T<sub>16</sub>—6J5 tube
- T<sub>17</sub>—6J5 tube
- T<sub>18</sub>—6J5 tube
- T<sub>19</sub>—6J5 tube
- T<sub>20</sub>—6J5 tube
- T<sub>21</sub>—6J5 tube
- T<sub>22</sub>—6J5 tube
- T<sub>23</sub>—6J5 tube
- T<sub>24</sub>—6J5 tube
- T<sub>25</sub>—6J5 tube
- T<sub>26</sub>—6J5 tube
- T<sub>27</sub>—6J5 tube
- T<sub>28</sub>—6J5 tube
- T<sub>29</sub>—6J5 tube
- T<sub>30</sub>—6J5 tube
- T<sub>31</sub>—6J5 tube
- T<sub>32</sub>—6J5 tube
- T<sub>33</sub>—6J5 tube
- T<sub>34</sub>—6J5 tube
- T<sub>35</sub>—6J5 tube
- T<sub>36</sub>—6J5 tube
- T<sub>37</sub>—6J5 tube
- T<sub>38</sub>—6J5 tube
- T<sub>39</sub>—6J5 tube
- T<sub>40</sub>—6J5 tube
- T<sub>41</sub>—6J5 tube
- T<sub>42</sub>—6J5 tube
- T<sub>43</sub>—6J5 tube
- T<sub>44</sub>—6J5 tube
- T<sub>45</sub>—6J5 tube
- T<sub>46</sub>—6J5 tube
- T<sub>47</sub>—6J5 tube
- T<sub>48</sub>—6J5 tube
- T<sub>49</sub>—6J5 tube
- T<sub>50</sub>—6J5 tube
- T<sub>51</sub>—6J5 tube
- T<sub>52</sub>—6J5 tube
- T<sub>53</sub>—6J5 tube
- T<sub>54</sub>—6J5 tube
- T<sub>55</sub>—6J5 tube
- T<sub>56</sub>—6J5 tube
- T<sub>57</sub>—6J5 tube
- T<sub>58</sub>—6J5 tube
- T<sub>59</sub>—6J5 tube
- T<sub>60</sub>—6J5 tube
- T<sub>61</sub>—6J5 tube
- T<sub>62</sub>—6J5 tube
- T<sub>63</sub>—6J5 tube
- T<sub>64</sub>—6J5 tube
- T<sub>65</sub>—6J5 tube
- T<sub>66</sub>—6J5 tube
- T<sub>67</sub>—6J5 tube
- T<sub>68</sub>—6J5 tube
- T<sub>69</sub>—6J5 tube
- T<sub>70</sub>—6J5 tube
- T<sub>71</sub>—6J5 tube
- T<sub>72</sub>—6J5 tube
- T<sub>73</sub>—6J5 tube
- T<sub>74</sub>—6J5 tube
- T<sub>75</sub>—6J5 tube
- T<sub>76</sub>—6J5 tube
- T<sub>77</sub>—6J5 tube
- T<sub>78</sub>—6J5 tube
- T<sub>79</sub>—6J5 tube
- T<sub>80</sub>—6J5 tube
- T<sub>81</sub>—6J5 tube
- T<sub>82</sub>—6J5 tube
- T<sub>83</sub>—6J5 tube
- T<sub>84</sub>—6J5 tube
- T<sub>85</sub>—6J5 tube
- T<sub>86</sub>—6J5 tube
- T<sub>87</sub>—6J5 tube
- T<sub>88</sub>—6J5 tube
- T<sub>89</sub>—6J5 tube
- T<sub>90</sub>—6J5 tube
- T<sub>91</sub>—6J5 tube
- T<sub>92</sub>—6J5 tube
- T<sub>93</sub>—6J5 tube
- T<sub>94</sub>—6J5 tube
- T<sub>95</sub>—6J5 tube
- T<sub>96</sub>—6J5 tube
- T<sub>97</sub>—6J5 tube
- T<sub>98</sub>—6J5 tube
- T<sub>99</sub>—6J5 tube
- T<sub>100</sub>—6J5 tube

detector circuit values, it was discovered that under one set of conditions, the detector would go out of superregeneration almost imperceptibly, the only noticeable change being the loss of noise. Under this condition of straight regeneration, it performed perfectly quietly and signals came in as on a broadcast receiver. The gain of the detector was reduced in this condition, but the signal-to-noise ratio was so far improved that the effective sensitivity was actually better. There was just one drawback to this type of operation and that was the large amount of ignition noise which came in as soon as the detector went out of superregeneration and into regeneration. Several types of audio noise limiting circuits were tried but without any real success. As a final attempt to clean up the ignition noise, a diode second detector was tried with an automatic series valve noise limiter. Another stage of i.f. was necessary to offset the loss in gain by not using the regenerative second detector. The resulting receiver was so satisfactory in every way that it was adopted as the final design and plans were drawn up to rebuild it into its present form. What had seemed at first consideration to be the more complicated way out proved to be the easiest to build and design in the end.

The gain of the finished receiver, in terms of absolute measurement, has very little meaning and is difficult to measure accurately, but it is safe to say that it is in the .05 to .1 microvolt region. The sensitivity of the i.f. strip alone is approximately 1 microvolt or better. By a direct comparison with the old superregen receiver, the sensitivity of the superhet receiver is 10 to 20 times as great. Signals that are just barely audible, yet not readable, on the superregen are S9 on the superhet. From S9 down to S3 or S4 a signal is workable on the superhet, and that means 15 to 20 db. of more workable signals than are available on the superregen. With the gain control set at the normal operating level there is no appreciable noise in the loudspeaker. At this level, all but the weakest signals come in with plenty of volume to be heard all over the house. Local signals require that the gain control be turned almost off to prevent their blasting the speaker. The selectivity is adequate, but not excessive. All but the very worst modulated oscillators are easily readable by detuning to the high side of their carriers. The actual bandwidth is somewhere around 100 kc. at 30 db. down. Three or four local stations can be on at the same time and provided they are not on the same frequency, they can be separated easily and four or five remote stations can be read between each of the locals. Local receivers cause very little trouble, if any. Some of the very bad ones are noticeable, but they are more of a nuisance than a menace inasmuch as they merely raise the apparent noise level of the receiver in the vicinity of

the signal to which they are tuned.

The stability of the superhet is excellent and no oscillator drift is noticed after a fifteen to twenty minute warm up period. After that the calibration remains unchanged in spite of sudden line changes or other conditions. In listening to crystal controlled signals the receiver can be tuned to their frequency and left there all night. The quality of speech is noticeably better than that of the superregen. The first time one operates such a receiver, after listening to nothing but superregens, he is immediately impressed by two things; the total absence of noise and the improved quality of voices. Having once handled and listened to the receiver, it is almost impossible to return to the superregen in any of its forms, with satisfaction.

Some of the special features of this particular design include the use of separate assemblies in the more critical sections such as the i.f. channel, the local oscillator, mixer, and r.f. amplifier. The former, as can be seen from the illustration, is built entirely on a small chassis 1" deep and 9" long and includes the three 6AC7 tubes, the four i.f. transformers, the 6H6 second detector and all of the associated resistors and bypass condensers that go to make up this part of the circuit. This method of construction gives very complete shielding, something which is vital to the successful operation of three high gain stages at this frequency. In addition, it affords a high degree of flexibility. Since the amount of selectivity required is about the only consideration which might change in future years and obsolete the receiver, the fact that the entire i.f. and second detector section can be removed as a unit and redesigned, is pretty good insurance against the receiver becoming outdated. As the

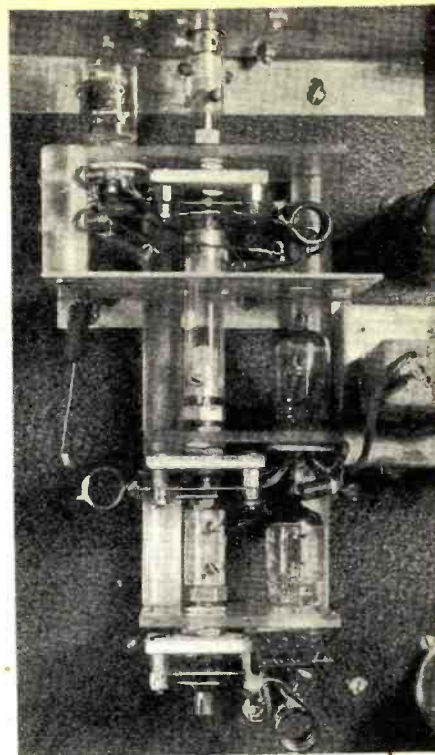

Enlarged view of the r.f. section of the receiver shows relative placement of parts.

diagram shows, the three 6AC7s are run at their full normal ratings and no loading is resorted to across any of the transformer windings. This results in a very high order of gain being developed in these three stages and means that very great precautions must be taken against stray coupling which would cause oscillation or even regeneration. The layout shown facilitates this problem considerably.

The transformers used in the final layout were purchased from war surplus and are tuned to 6 megacycles.

(Continued on page 142)

Top view of completed 144-148 mc. superheterodyne receiver.

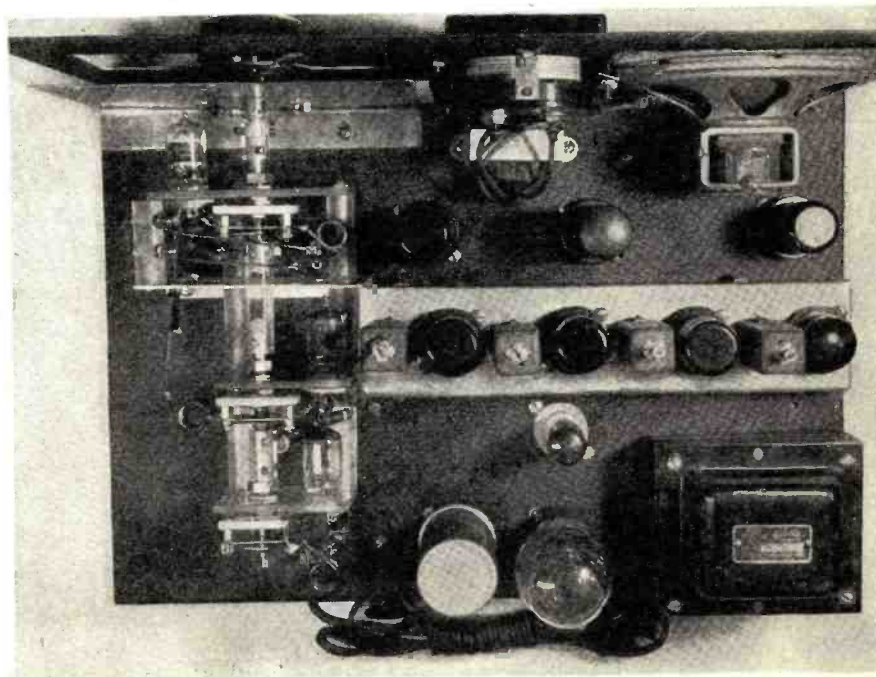

# The 829-B and 832-A at Audio Frequencies

*Facts and figures on the operation of two popular twin-beam power tetrodes. These versatile tubes are ideal for both amateur rigs and p.a. systems.*

By  
**JAMES A. FRED**

**T**WO of the more versatile tubes on the war surplus market are the 829-B and 832-A. These are twin beam power tetrodes contained in one glass envelope. They are very compact and small in size.

All transmitting tube manuals carry voltage and current ratings for these tubes when used at radio frequencies. They are also quite efficient at the higher frequencies which make them attractive to amateurs. However there does not seem to be any available data on these tubes taken at audio frequencies.

Desiring to know if these tubes

could be used at audio frequencies, the setup pictured in Fig. 1 was utilized to determine what could be expected in the way of audio output at

moderate d.c. operating voltages. This is not a circuit which could be used in practical construction but one which was suited for this particular project. All measuring instruments are of the type generally found in well equipped industrial radio laboratories.

In the circuit diagram of Fig. 1 the 829-B or 832-A under test is furnished with continuously variable d.c. voltages by adjusting the variac in the primary of the high voltage transformer  $T_4$ . A simple filter circuit consists of the variable resistor  $R_{10}$  and two 15  $\mu$ f. condensers. This reduces power supply hum to .05 mw. which was low enough for these tests.

A 400 cycle signal is fed to the push-pull input transformer  $T_1$  by an audio signal generator. The audio voltage applied to the grids is measured by a vacuum tube voltmeter. The cathode voltage is varied by resistor  $R_k$  and is measured by voltmeter  $E_k$ . The screen grid voltage is varied by resistor  $R_{10}$  and measured by voltmeter  $E_{10}$  and screen grid current is measured by ammeter  $I_{10}$ . The plate voltage is measured by voltmeter  $E_p$  and plate current is measured by ammeter  $I_p$ . The output goes to transformer  $T_2$ , a push-pull output transformer offering a plate load of 5000 ohms per plate, and is measured by an output meter. An oscillograph was used to check distortion of the output wave shape. Voltmeters and ammeters of  $\frac{1}{2}$  of 1% accuracy were used for other measurements. Filament voltage was maintained at 6.3 volts throughout the test.

Table 1 shows the results obtained and voltages applied to the tube elements. Column 1 shows values arrived at with an 829-B tube with 500 volts on the plates. This is much less than the maximum voltage recommended by the manufacturer for r.f. operation. In column 2 are the values obtained from a power supply constructed with an ordinary receiver type power trans-

(Continued on page 172)

**RADIO NEWS**



Fig. 1. Test set-up that was used to check operating characteristics of the tubes.

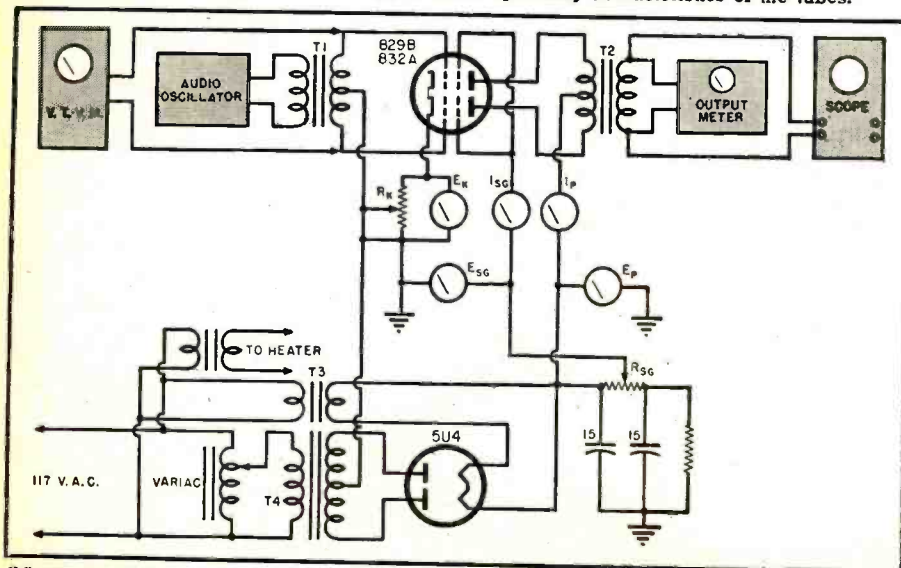

# A Low Cost PHONO AMPLIFIER

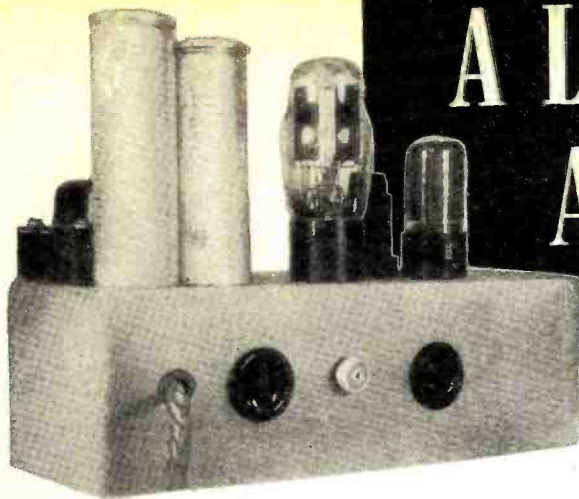

Two views of the a.c. operated amplifier.

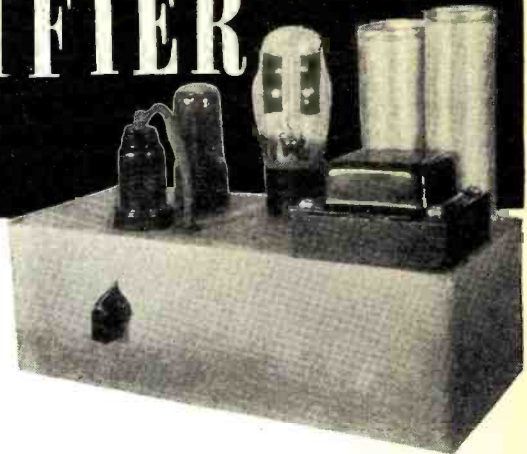

By **GEORGE R. CRYDER**

**Construction details for an audio amplifier that is easy to build and requires a minimum of parts.**

**A**FTER trying any number of different circuits for low power phono amplifiers, the writer has found the unit described in this article to be one of the most satisfactory. This is true both from the construction viewpoint as well as cost, as the amplifier uses only three tubes.

The tube line-up is quite conventional, utilizing a 6J7 as pre-amplifier which, in turn, drives a 6V6 beam-power amplifier tube in the output stage. This gives better than 5 watts, with a very low percentage of distortion. Five watts have also been found to give more than enough power to drive a 12 inch speaker at room or listening level. The rectifier is a type 80. Others could, of course, be used, such as the 5Y3, 83V, etc.

The photographs are self-explanatory but a few words on the design and construction might be in order. The first requisite was as low a hum level as possible, in fact, no audible hum when there was no input voltage. By using a little extra filtering in the power supply section this result was obtained quite easily. This extra filter is made up of the speaker field coil acting as an extra choke, with an extra 16 $\mu$ fd. electrolytic condenser.

The method of obtaining inverse feedback in this circuit is only one of several possible ways. However, this parallel feed idea was used because it is simple and practically foolproof in actual operation. In this circuit some of the output voltage is picked off through a voltage divider network and is fed back, out of phase, into the grid circuit through the plate circuit of the 6J7. Of course this means a slight reduction in gain, which is governed by the ratio of the resistors in the network. This slight disadvantage is overshadowed, however, by the subsequent reduction in distortion, and a more linear response over the full

frequency range of the amplifier.

The construction layout is quite conventional, all parts being mounted on a standard sized chassis. The filter choke, not visible in the photograph, is mounted below, but may be mounted wherever it is most convenient. The input circuit is, of course, shielded, and a little better results were obtained by shielding the output, especially when utilizing full output.

The 6J7 has plenty of gain so any of the better makes or types of crystal

phono pickups may be used. In fact a carbon type mike may also be used with this amplifier by the addition of a mike input-to-grid transformer in the grid circuit of the 6J7. The use of a crystal or dynamic mike is not recommended, however, without the addition of another stage of amplification.

A power output plug has also been included for convenience. This makes it possible to plug the phono motor into the rear of the amplifier for 110 v., using only one power cord. -30-

Schematic diagram of the 3-tube audio amplifier. Power output is approximately 5 watts.

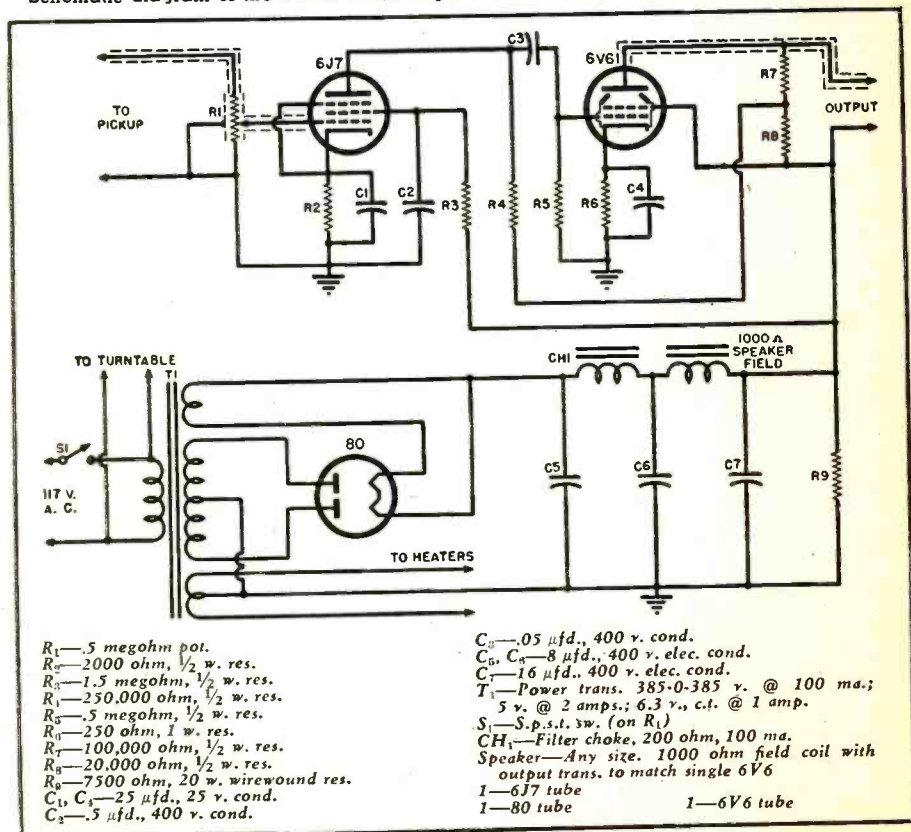

# The Recording and Reproduction of SOUND

**Part 7. A discussion of representative microphones widely used in recording.**

By  
**OLIVER READ**  
Editor, RADIO NEWS



Typical group of microphones suitable for recording work.

**T**HERE are three fundamental types of microphones (transducers). These are the carbon, crystal, and dynamic. Each type employs a specific fundamental principle of operation. While there are many variations on the above three types, we shall confine most of our discussion to the construction and application of those enjoying the greatest popularity.

A carbon microphone functions as follows: Direct current flows through the carbon granules. As the pressures and rarefactions of the sound waves occur at the diaphragm, the diaphragm is caused to move and to press and release the carbon granules. The action is decreasing and increasing resistance within the microphone. Accordingly, pulsating direct current results, the pulsating or alternating part having the same waveform as the original sound wave. The characteristic of the carbon microphone is its

high output level and its ruggedness. It is practically unaffected by heat and humidity. Wherever space and weight are a factor, its high output is advantageous, due to the fact that one or two preamplifier stages may be eliminated. During the war this type of microphone was widely used by the military services. It is used presently by airline and railroad companies, police, etc. The construction of the single button carbon microphone is illustrated in Fig. 1.

In the early days of broadcasting the most commonly used microphone for

high quality pickup was the *double button carbon*. This is illustrated in Fig. 2A. For many years this was standard equipment with all the broadcasters and, although it had its limitations, it proved very successful until replaced by the more popular velocity, dynamic, and other types. Carbon microphones, being of the pressure type, are largely used in mobile communications. They possess extremely good response at voice frequencies. The harmonic content of a single button microphone, due largely to the non-linearity of the carbon itself, is a source of at least 10% harmonic distortion even in the more advanced types. This, however, is no handicap when we limit the over-all response to voice frequencies. Generally speaking, carbon microphones are usually of 100 ohms impedance and are fed direct to a transformer or to a resistor input to the preamplifier.

### Crystal Microphones

The *crystal* microphones, of which there are several types, employ bimorph Rochelle salt crystals. The

Fig. 1. Single button carbon microphone.

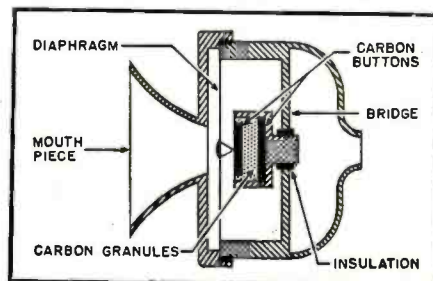

crystal element itself consists of two Rochelle salt slabs which are assembled in such a manner that they respond to a bending stress. The two slabs are provided with three foil electrodes so that the assembly is capable of generating a potential between the inner and outer foils whenever subjected to a strain or bending. Fig. 2B illustrates the construction of a diaphragm actuated crystal microphone. A drive pin is connected to one or two corners of the crystal and the other end of the drive pin is attached to a diaphragm. The movement of the diaphragm and drive pin bends the crystal in accordance with the pressure of the sound waves. This creates an alternating potential of substantially the same wave pattern as the sound wave. A crystal microphone does not require a separate voltage or current source, as is the case with the carbon microphones. The output of the microphone, accordingly, can be connected directly to the grid of an amplifier tube. The chief disadvantage of the crystal is that its operation is confined to temperatures of less than 130 degrees F. Temperatures over 130 degrees F. cause the crystal elements to soften due to excessive heat and the microphone is rendered inoperative.

The construction of the crystal microphone illustrated in Fig. 2B is the simplest form of crystal microphone. They are widely used for communications mikes and for the tiny hearing aid devices.

### Sound Cell Microphones

A *sound cell* microphone consists of two bimorph crystal elements as illustrated in Fig. 2C. These elements are assembled back to back and are enclosed within a rectangular bakelite frame, sealed by two flexible membranes. The crystal elements are held together by two resilient mounting pads located in such a manner as to provide proper damping characteristics and to separate the elements, permitting them to deflect under application of sound pressures. No diaphragms are required in a sound cell microphone since sound pressures contact the crystal elements directly.

After assembly, the completed sound cell is impregnated with wax to render it airtight and moisture-proof. The result is a small, flat, hollow box, the two major sides of which generate a voltage in proportion to the applied pressure. For sound pressures, the voltage generated by one side will be in phase with that generated by the other and for this reason are additive. In the case of mechanical shock or vibration, the voltages will be out of phase and will tend to cancel each other. Due to the linear relationship between sound pressure and voltage, amplitude distortion does not arise as is the case with practically all other types of microphones. Crystal elements used in sound cells have been designed so that their mechanical resonances are usually above the highest frequency to be reproduced. In higher quality sound cell microphones, very

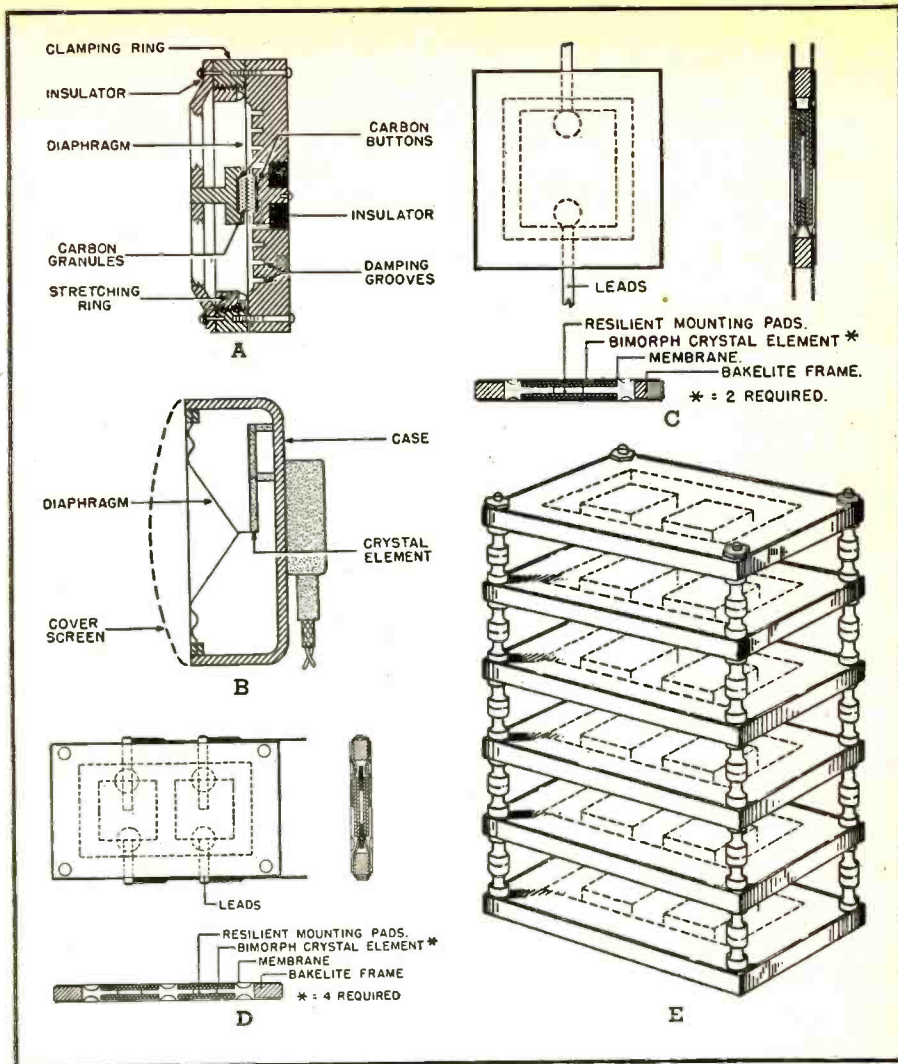

Fig. 2. (A) Double button carbon, (B) crystal diaphragm, (C) sound cell, (D) multiple sound cell and (E) six element sound cell construction.

small and very thin crystal elements are used, in which case the mechanical resonance is just above 10,000 c.p.s. causing the response to rise slightly at the upper frequency range. This increased output may be found useful in compensating for the high frequency loss in associated equipment, or it may easily be compensated for true equalization.

In some microphones single "sound cells" are used as illustrated in Fig. 2C. In others, double "sound cells"

are used as illustrated in Fig. 2D. Usually a number of these are stacked together to provide proper operating characteristics. Sound cell microphones have been developed for various applications. They are ideally suited to high quality broadcasting, recording, audition and sound reinforcement applications. Generally, these are designed for connection to high impedance circuits but with special coupling transformers may be fed to low impedance lines. Each of these

Fig. 3. Input connections for sound cell microphones.

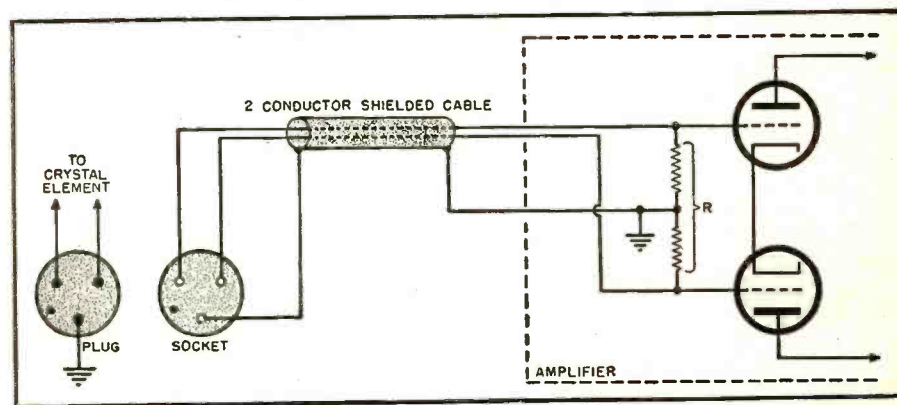



Fig. 4. Moving coil (dynamic) microphone.

microphones has a substantially uniform response up to 10,000 c.p.s. Each contains six double sound cells stacked as shown in Fig. 2E. The connections to the cells, however, differ for some models.

Sound cells have also been used in other devices such as laboratory microphones, artificial ears, etc. where very accurate measurements are required. For these applications the response is uniform up to 15,000 c.p.s. This is accomplished by using extremely small sized crystal elements ( $\frac{7}{32}$  in. sq. x .015 in. thick) in which the mechanical resonance is well above 40,000 c.p.s.

Each sound cell microphone is terminated in a three point plug-in socket. Two of the contacts are connected to the output terminals of the sound cell assembly. The third contact is connected to the case of the microphone. This permits connection to single tube or push-pull grid inputs as shown in Fig. 3. Since the crystal elements of the microphone are capacitive over practically their entire frequency range, it is very important that each microphone be operated into the load impedance as recommended by the manufacturer. The capacity of the crystal elements will vary somewhat

with temperature. However, this will have no effect on performance if recommended load impedances are used. Sound cell microphones should never be subjected to temperatures exceeding 125 degrees F. since the piezoelectric properties of the crystal elements may be damaged permanently.<sup>1</sup>

#### Non-directional Microphones

Pressure microphones respond to variations in sound pressure. They include dynamic, carbon, crystal, condenser, and ribbon microphones with closed backs. These are substantially non-directional although they tend to become directional at the higher frequencies. For a microphone of  $2\frac{1}{2}$ " diameter, directivity starts at about 2000 c.p.s. and increases with frequency. Often baffles are used to lower the frequency at which directivity begins. But, as these add some frequency distortion, the design of the microphone must be coordinated with them.

The frequency response is uniform with respect to distance from the sound source excepting, of course, the frequency distortion caused by reverberation within the room in which the microphone is used. In a hard, untreated room this effect can be serious when working more than a foot or so from the instrument. Pressure microphones usually have comparatively stiff diaphragms and are therefore not as susceptible to wind and breath.

Carbon microphones of the pressure type are largely used for mobile communications service as mentioned previously. Pressure microphones in the dynamic type are available in high impedance (25,000 ohms) for feeding direct into grid or 50, 250 or 500 ohms for matching a line.

Pressure microphones are excellent all-purpose instruments for conditions where room reverberation, acoustic feedback, and ambient noise are not too severe. The better quality type are desirable for broadcast announcing and remote, public address, amateur communications, and recording. They are recommended for outdoor as well as for indoor work.

<sup>1</sup> Brush Development Co., Brush Technical Bulletin No. 320.

<sup>2</sup> Electro-Voice Microphones.

#### Differential Microphones

This type of microphone was used by nearly all branches of the U. S. Armed Forces in reproducing speech through high surrounding noise. The same basic principle of operation makes it highly desirable for all applications where ambient noise is 100 db. or more. The *Differential*<sup>2</sup> discriminates against the distance of origin and not sound pressure alone. For example, if background noise originating from a foot or more away is the same sound level at the microphone as speech which originates one quarter inch away, the reproduced speech is from 17 to 20 db. higher than the noise, despite the fact that these two sound pressures arrive at the microphone at the same intensity. The *Differential* is made in both carbon and dynamic types and provides high articulation and good quality reproduction. For public address applications, the *Differential* shows remarkable freedom from acoustic feedback. It is essential, however, that they be used closely, to within  $\frac{1}{4}$  inch to  $\frac{3}{8}$  inch, or speech itself will be attenuated. Basically, the *Differential* is a close talking microphone and is highly effective in reproducing speech under high ambient noise. It is ideally suited for use by railroads in their communications work. As a carbon hand-held microphone, it is used by many airlines and air transportation companies. It is also used by broadcasters for sporting events, such as boat races, where the background noise is high.

#### Broadcast Microphones

The following paragraphs will deal with several representative types of high quality microphones designed especially for broadcast applications or for use in professional sound recording studios.

Most stations prefer velocity or "ribbon" microphones for studio work, because of their wide-angle pickup and adaptability to various applications, while dynamic or moving-coil microphones are used in outdoor or remote broadcasts where ruggedness plays a major part. Cardioids, of course, are suitable for all applications and receive a good deal of use.

A good example of the moving-coil type of microphone is the *Western Electric 618-A* (Figs. 4 and 5). This microphone has long been used where ruggedness, good frequency response, and ease of handling are requisites, and is especially suited for use in the broadcasting (or public address) of outdoor events. It holds an advantage over the ribbon type in such events in that it is not so easily damaged by reasonably rough handling, is not as sensitive to "blasts" or instantaneous peaks of excessive level, is not adversely affected by wind, and, by virtue of its unidirectional characteristics, aids considerably in the reduction of background noise usually present in outdoor applications.

The high-frequency response above  
(Continued on page 118)

Fig. 5. Cross-section view of moving coil microphone.

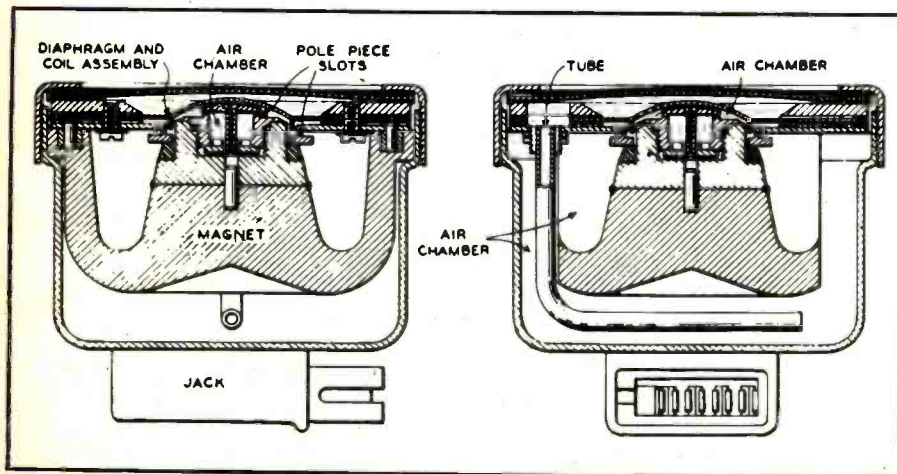



Front panel view of the completed v.f.o. This unit was built from a Signal Corps transmitter tuning unit, TU-5-B, designed to cover the range of 1500-3000 kc. →

By  
**ROBERT W. FIELD,**  
W4KAP

**Conversion of a popular war surplus tuning unit into a stable v.f.o. that covers the frequency range from 3.5 to 4 megacycles.**

**T**HE present day crowded conditions existing on the amateur bands make a variable frequency oscillator a very desirable addition to any station. This is especially true of low power rigs.

It was decided to build a v.f.o. to cover the range from 3.5 to 4.0 megacycles. The unit was required to have sufficient stability to allow for doubling even to the 28 megacycle band. Examination of one of the plug-in tuning units, originally built to be used with the BC-191F and BC-375E Signal Corps transmitter, convinced us that here was the ideal foundation unit for use in constructing a variable frequency oscillator. The tuning units are readily available at a cost of less than five dollars. They come complete with a crackle finish, steel dust cover which is used for the final v.f.o. cabinet. Six different frequency tuning units are available, however, the 1500 to 3000 kc. range was selected as it was felt that this choice would result in a higher "C" circuit at the desired 3.5 to 4.0 mc. range.

These units are beautifully constructed, having temperature-compensated condensers in shunt with each fixed condenser that is used in the oscillator tank circuit. This results in a high degree of stability.

Actually the unit is free from noticeable drift after the heaters have been turned on for only a minute or two.

The original tuning inductance is constructed of heavy wire wound on a threaded isolantite form. Only eleven turns were found to be needed but rather than remove turns and take a chance of loosening the winding it was decided to merely tap down on the coil.

The dial supplied with these units is ideal for v.f.o. use, having a total of 2500 divisions for a range of 3500 to 4000 kc. This means that five divisions are equal to only one kilocycle change at the fundamental frequency. The original tuning unit is built with the vernier dial and main tuning condenser located on the left hand side of panel. Directly below the dial is a fan-type range switch that was used for increasing the capacity in shunt

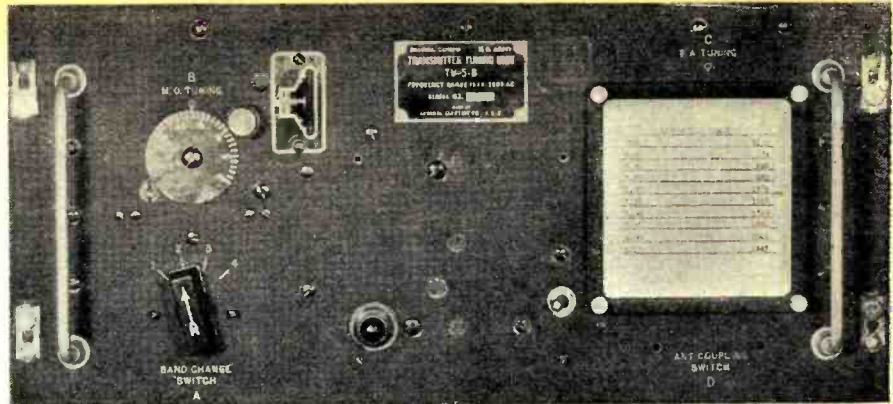

# A Variable FREQUENCY OSCILLATOR

with the main tuning condenser. Each of these steps, as previously mentioned, has a bimetallic strip arranged for compensating temperature drift.

It was found that the desired range could be obtained with a total of 200  $\mu\text{fd.}$  in shunt with the main tuning condenser. This value of capacity is obtainable with the switch in position No. 2.

To prevent the Junior Ops from accidentally throwing this switch and getting their OM in dutch with the FCC it was felt that this switch should be locked.

This was readily accomplished by soldering a metal strip to the switch mechanism.

The photograph shows an aluminum (Continued on page 163)

Schematic diagram of the variable frequency oscillator.

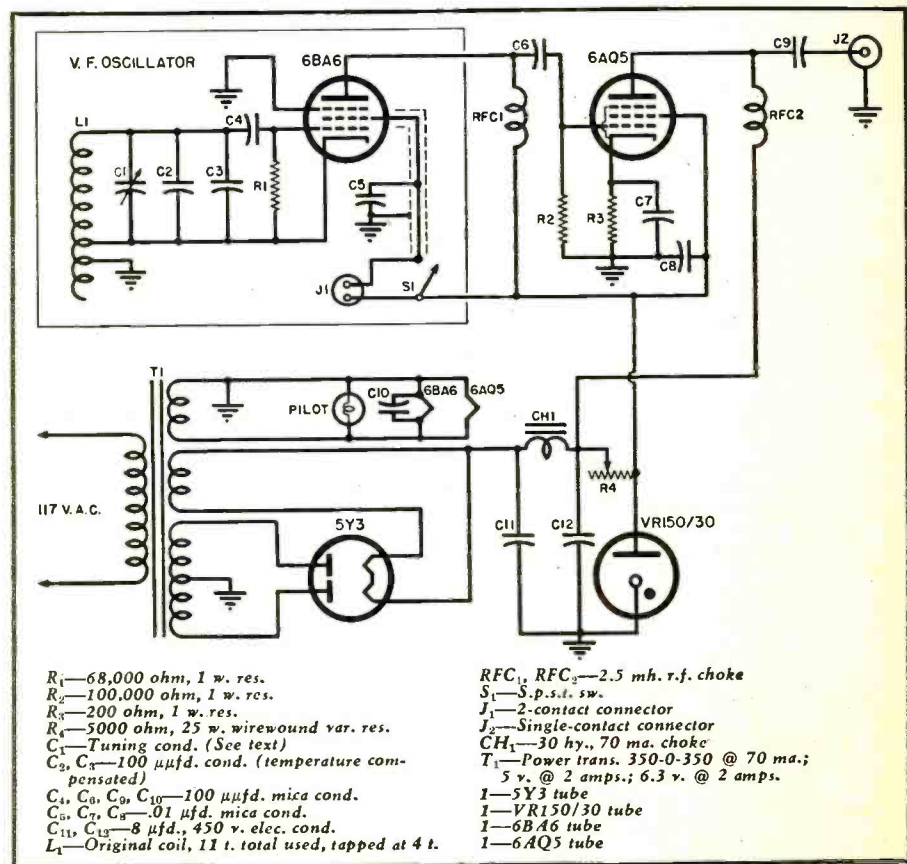

# SOUND BROADCASTING from Airplanes

*The installation and servicing of sound equipment in planes can provide an added source of income for the radio serviceman.*

**By SAUL J. WHITE**

Chief Eng., University Loudspeakers, Inc.

**D**URING the war high-powered sound systems were used in military aircraft for sound broadcasting to the ground during invasion operations, and for propaganda purposes. The Coast Guard has equipped planes with sound systems for its Air-Sea Rescue Division. Now, with the peace, there is a growing interest in "sky broadcasting" for commercial advertising. Former military pilots and radiomen have turned to this novel field of advertising as a lucrative and exciting occupation. One enterprising flying corporation, organized by ex-G.I.'s, has equipped five airplanes for air-to-ground advertising. A Morristown, New Jersey, flying service has equipped an autogyro similarly.

### Power Requirements

For effective airplane broadcasting of sound, audio power of 100 watts or more is required. Energy below this is unreliable because of the effect of wind, noises on the ground, and the necessity for flying at considerable heights, especially over congested areas. It is preferable that this full power be handled by a single loudspeaker. If greater sound coverage is desired, additional speakers each capable of handling 100 watts should be installed, and corresponding increases of amplifier output made available. Speakers with narrow projection angles are most effective because of the concentration of sound intensity on the ground. To obtain maximum intelligibility and acoustic output, both the loudspeaker and the amplifier should be so designed as to cut off all frequencies below 200 or 300 cycles. Low frequency or bass notes do not add to the clarity, but only serve to overload the equipment. Most plane engine noises are in the low frequency range, and hence this

Temporary installation of 100 watt loudspeaker and amplifier in a Piper Cub. Speaker projects out of open door.



type of pickup through the microphone is minimized where the bass is cut off in the amplifier and speaker. Where high intensity and wide ground coverage are required, the practice is to use either a greater number of speakers or a single speaker with wide dispersion angle capable of handling greater audio power, 200-300 watts.

### Dispersion Angle

The dispersion angle of the loudspeaker is of some importance in the case of high speed planes from which an announcement or message of any length is to be broadcast. It can be realized that if the beam of the speaker is narrow or sharp and the plane is traveling at 100 m.p.h. or more, that the projection area on the

ground would pass over a stationary listener in a very short space of time, usually a matter of seconds. Therefore, it becomes necessary that all announcements be made short and that they do not exceed the estimated "ground time" which is determined by the dispersion angle, the rate of speed of the plane, and its height. Consider the case shown in the following illustration. Here a plane flies at 1500 feet, at a speed of 100 m.p.h. The speaker has a dispersion angle of 45°, this representing the width at which maximum intelligibility and intensity is obtained. It is, therefore, a matter of very simple computation to realize that a message from the plane covers a ground diameter of 1250 feet and could be heard by a listener for only nine seconds.

Determination of dispersion angle of loudspeaker is necessary in order to gear an advertising message for maximum intelligibility with relation to the listener.

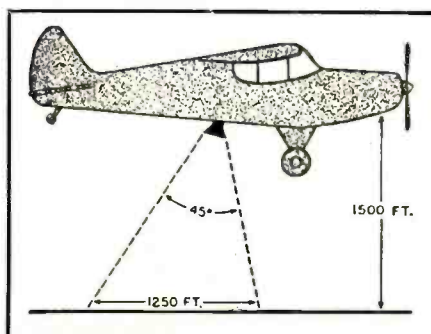

### Reduction of Acoustic Feedback

Because of the high power required and the fact that the loudspeaker is within a few feet of the microphone, acoustic feedback may occur before the necessary sound intensity is obtained. The following recommendations are made to permit larger volume to be built up before feedback occurs.

First, the loudspeaker should be so mounted that it points slightly to the rear of the plane. In other words, in addition to pointing downward, it must also point to the rear. This allows the sound to flow partially with the slip stream. The microphone should

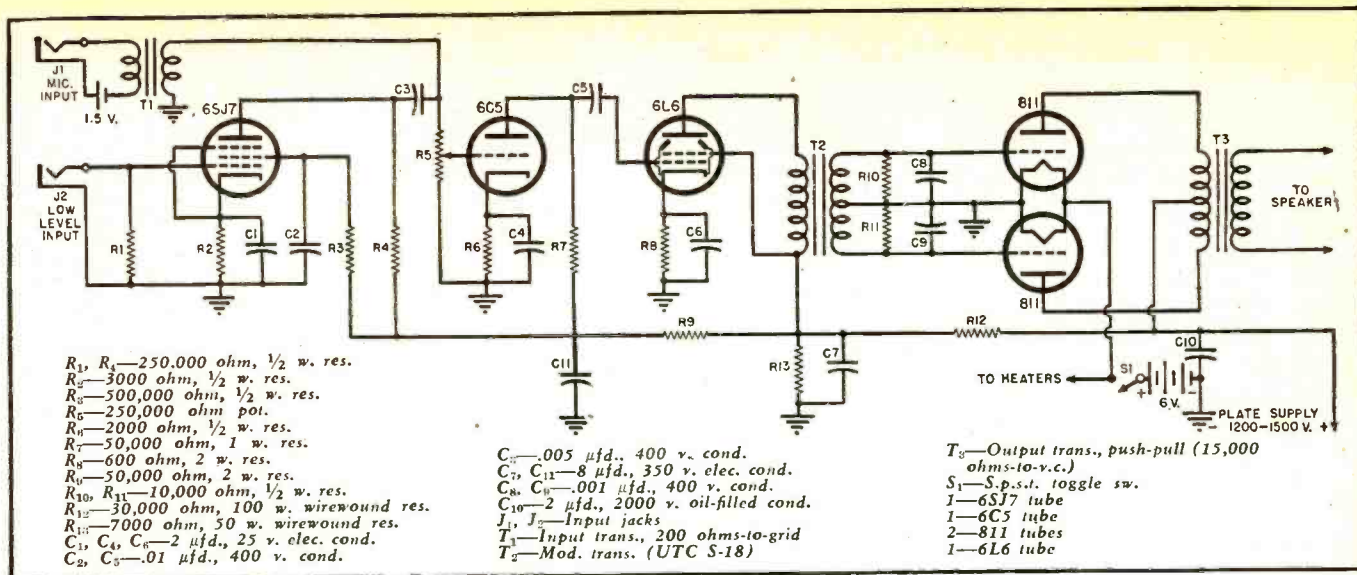

Schematic diagram of a 150 watt audio amplifier. The mike input is for a single-button carbon lip mike, while the low level input may be used for the input of a wire recorder.

be located "upwind" from the loudspeaker.

A great improvement will result if the loudspeaker mouth projects about a foot into the slip stream or beyond the fuselage of the plane. The best possible results are obtained where the entire loudspeaker is hung outside of the fuselage and mounted on a wing strut or under the nose of the plane.

#### Microphone

If the reproduction is to be obtained from a microphone, it is imperative that only a close talking microphone be employed. The recent lip type microphones and especially the differential type are excellent for reducing feedback to a minimum as well as eliminating a lot of the engine noises which would otherwise be picked up by the microphone and reproduced over the speaker.

#### Phono

Reproduction from a phonograph would be extremely difficult from an airplane because of the vibration and the banking. Unless an extremely complicated design were worked out, it would be impossible for the pickup to ride in the record groove. Reproduction from a magnetic wire or tape recorder, or film sound track, however would be excellent since these are not affected by vibrations and other normal maneuvers of the airplane. Magnetic recorders, however, are unquestionably the best source for the message. Announcements are recorded in advance on the ground.

#### Wind

Wind is an element which frequently ruins what would otherwise have been a good performance, but unfortunately the results can not be made uniform because of the variation in wind velocity and direction of the airplane. The effect of variable wind in any direction would be to cause considerable fading and this

effect will increase as the distance between the listener and the loudspeaker increases. If the wind is gusty and the plane engages in changes in heading, the sound as the listener hears it will vary in intensity.

#### Power Supply

Most sound installations in aircraft operate from a rotary converter, using 24 or 32 volts d.c. storage battery input and having 110 volt a.c. output, which is fed to the amplifier. This naturally entails considerable amount of weight and, of course, the plane must be capable of carrying this load in addition to the weight of the amplifier and loudspeaker. The rotary converter method is the simplest because it permits the use of available commercial amplifiers. However, where weight is at a premium, as in a light plane of the Piper Cub class, and it is

imperative that equipment weight be reduced, the amplifier should be custom-built to operate from 12 volts d.c., utilizing a genmotor delivering the required d.c. plate voltage. This eliminates the weight of the high voltage and filament transformers. The circuit should eliminate all non-essential features, contain only the necessary input and output channels. Where a low frequency cut-off of 300 cycles is specified, the weight of the output transformer can be reduced. The circuit should be reduced to the simplest form.

In certain planes it may be possible to couple a 110 a.c. generator to some part of the power plant so that at cruising r.p.m. the generator driven by the engine will deliver the correct voltage. However, this is difficult in most engines below 200 h.p. because  
 (Continued on page 104)

A Consolidated Vultee AT-6, purchased by an ex-AAF pilot from Army surplus, is shown being equipped with a University Model B-6, 150 watt loudspeaker unit.





# International SHORT-WAVE

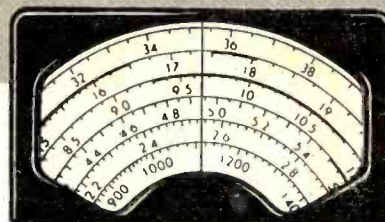

Compiled by **KENNETH R. BOORD**

**W**E ARE pleased this month to dedicate the ISW Department to radio in Ceylon, and particularly to *Radio SEAC* (South East Asia Command), Colombo.

Thanks go to Chief Engineer Bernard Blakemore for permission to draw from material he wrote in the May issue of *SEAC Forces' Radio Times*, which publication is edited by Ronald George. An operational outline, the technical aspects of the station, and "*Radio SEAC and You, the Listener*" are subjects covered in a technical supplement that has recently been issued by the station. This folder may be obtained from the Chief Engineer. The *Forces' Radio Times* is distributed throughout Aden, India, Burma, Ceylon, China, Malaya, Borneo, New Zealand, Australia, Japan, British Pacific and East Indies Fleets, and selected listening posts throughout the world.

*Radio SEAC*, The Forces Broadcasting Station, first came on the air as experimental station ZOJ in October 1944, radiating for only a few hours each day from a borrowed transmitter and from borrowed studio space. In March 1945, a 7½-kw. transmitter beamed eastward from Ceylon

opened and the station's name became *Radio SEAC*. Broadcasting hours were increased to 9½ per day. During this time, however, a bigger station was being planned and the first experimental transmissions with the 100-kw. unit were made in April 1946. On the first day of May the new schedule started, including 16½ hours a day on two transmitters—the new 100-kw. unit and the original 7½-kw. *RCA* transmitter.

The broadcasting system of *Radio SEAC* now consists of three main units—the receiving station at Horahena, the studio center in Colombo, and the transmitting site at New Ekala. All are situated on the western side of Ceylon and the transmitting site is particularly suitable as the island is surrounded in all except the northerly direction by vast oceans.

The station, when planned, was intended specifically to provide a good signal over the area included in the South East Asia Command and, in addition, has facilities for beaming transmissions to Australia and New Zealand, and to the United Kingdom.

At the present time the antenna systems in daily operation are beamed on India (350° N. of W.) and Japan

(036° E. of N.) and the Pacific (080° E. of N.) and once a week, on Sunday evening (in Ceylon), the United Kingdom beam is brought into operation on a bearing of 322° N. of W., which array can also be used on its reciprocal for Australia and New Zealand.

The receiving station at Horahena is equipped with two banks of *RCA* AR-88 receivers which are used in triple diversity to receive transmissions from the United Kingdom and *Radio Australia*. In all cases, rhombic antennas are used and are fed to the receivers via wide-band r.f. amplifiers and the usual line switching and monitoring facilities are provided. The audio output from the receivers is fed to the studio control room and thence to the transmitting site by overhead telephone line.

The transmitter building houses one 100-kw. *Marconi* SWB-18 transmitter and two operational *RCA* ET-4750 7½-kw. units. In addition, one small 1-kw. transmitter is also in operation and it is hoped that another 7½-kw. transmitter of a similar type will be available in the near future. "Even so, these transmitters do not allow us to take full advantage of all the facilities available in the shape of antenna systems," comments Chief Engineer Blakemore, "but do, however, provide general coverage over South East Asia."

The 100-kw. transmitter is normally directed on Burma and Japan but has an antenna system which is designed to provide a wide beam of approximately 70 degrees. The two *RCA* transmitters are normally operational on the India beam on 49 meters and the Pacific beam on 16 meters. From this it will be appreciated that though the operational frequencies are not always optimum, under favorable conditions a good signal should be maintained for the greater part of the day throughout India, Burma, Malaya, the near Pacific and Japan.

The 100-kw. transmitter, although of utility construction, is of modern design and follows very closely the lines of its more expensive brothers; the output stage uses two *Marconi* CAT-17 tubes which are modulated by "Class B" modulation using two CAT-20-C tubes. The input to the final amplifier is normally 110 to 150 kw., depending upon the frequency in use. The r.f. driver unit consists of a ten-way thermostatically controlled crystal oscillator, the crystals for which

Entrance to *Radio SEAC's* transmitting site located among the coconut palms 15 miles outside Colombo. The site is guarded by Ceylonese soldiers. The Sinhalese driver of the passing bullock cart shows great interest in the camera. Difference between "Ceylonese" and "Sinhalese"? The "Sinhalese" are a race, oldest in Ceylon. "Ceylonese" is a generic term embracing all subjects of Ceylon, including Sinhalese, Tanils, and Burghers (descendents of early Dutch and Portuguese settlers).



# NOW!

*in* 1,000 pages:

All data and basic knowledge in radio and electronics digested into 12 sections... in a complete, quick to find, easy to read, handbook form.

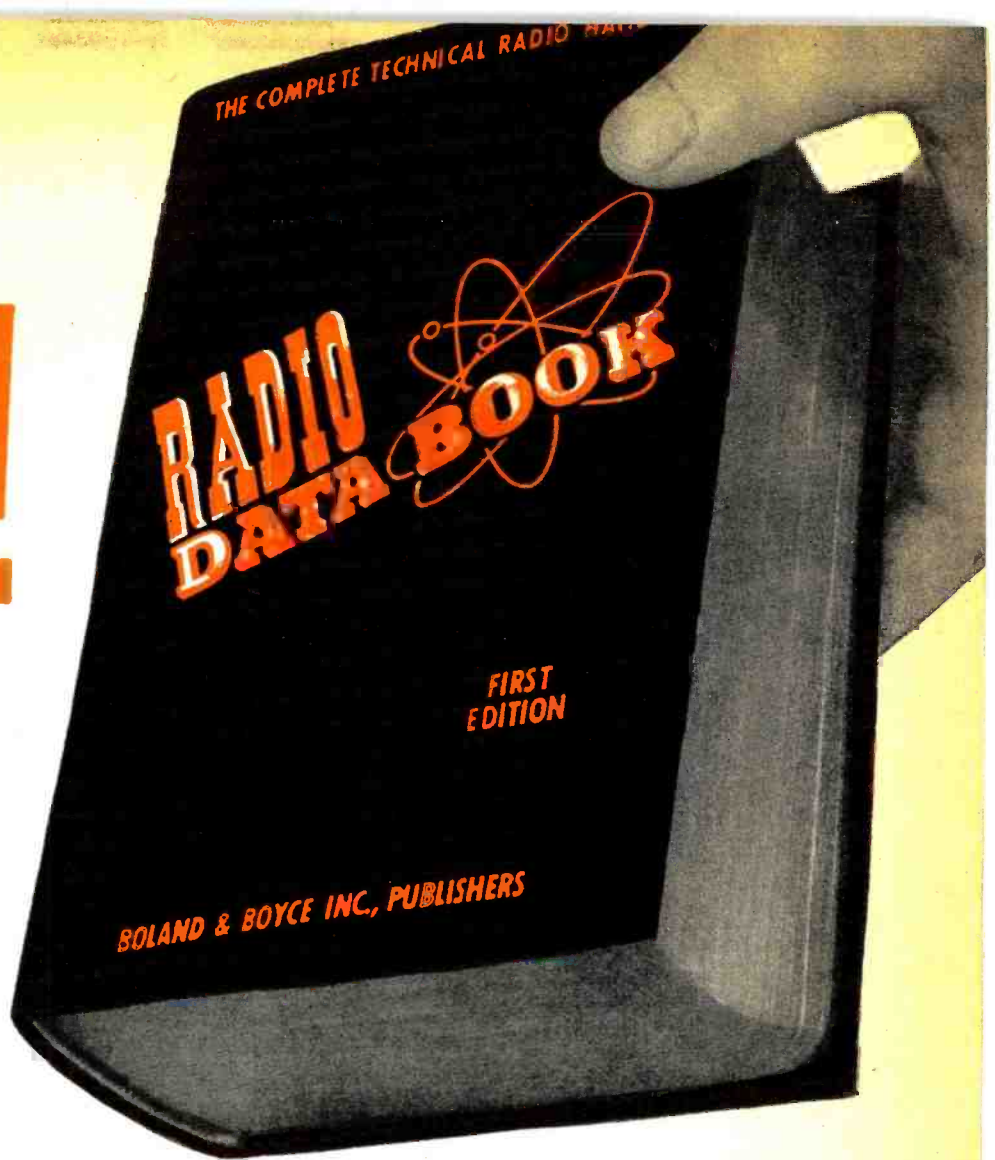

Plan every operation in radio and electronics with the *Radio Data Book*. This new radio bible will be your lifelong tool... you will use it every day, on the board, at the bench, in the field! Use it for construction, troubleshooting and testing. The RADIO DATA BOOK will be your invaluable aid in design, experiment and in layout. It will help make your production better, faster and easier. In any and every operation in radio and electronics, you will use the RADIO DATA BOOK!

**CONTENTS**

Each section is a COMPLETE coverage of its subject... 12 sections... 12 books in ONE! 1000 pages... Schematics... Accurate photographs... Specially prepared drawings... White on black charts... Diagrams... Isometric projections and exploded views.

Section 1. **THE 150 BASIC CIRCUITS IN RADIO.**  
Every circuit is analysed and explained in a Johnny-on-the-spot reference for any occasion.

Section 2. **COMPLETE TEST EQUIPMENT DATA.**  
Know more about the test instruments you now have... Find the new ones you want to buy... They're All in here—impartially described!

Section 3. **TESTING, MEASURING AND ALIGNMENT.**  
Simplified operation of the Oscilloscope... See what's happening inside any radio circuit... Dynamic alignment—AM, FM and TELEVISION made easy with the Oscilloscope... Scientific use of the Vacuum Tube Voltmeter, Signal Generating Equipment and other basic instruments.

Section 4. **ALL ABOUT ANTENNAS.**  
AM-FM-Television... design, installation, characteristics, construction and feed.

Section 5. **SOUND SYSTEMS.**  
Planning, installing and servicing a PA System. A complete chapter on every component... How to select and combine components... estimating costs... even acoustic requirements!

Section 6. **ELECTRICAL AND PHYSICAL CHARACTERISTICS OF RADIO COMPONENTS.**  
Know the size, the power, the shape! A quick reference on the construction and design of any circuit or equipment.

Section 7. **COMPLETE TUBE MANUAL.** Receiving, transmitting and Commercial.  
A Rick of the pages brings you to all the data and ratings of any tube model

Section 8. **CHARTS, GRAPHS AND CURVES.**  
Quick calculation devices... Plotting curves, nomographs, rules and tables for speedy solutions to radio problems.

Section 9. **CODES, SYMBOLS AND STANDARDS.**  
Handy reference to all radio symbols and abbreviations; code symbols, phrases and characters... Where you want them... When you want them!

Section 10. **50 TESTED CIRCUITS DESIGNED FOR OPTIMUM PERFORMANCE.**  
Find any circuit you want with complete parts lists and specifications... One tube receivers to complete AM, FM and Television receiver circuits... Amplifiers... Transmitters... Test Equipment and Control Circuits... All with the latest engineering refinements.

Section 11. **DICTIONARY OF RADIO AND ELECTRONIC TERMS.**

Section 12. **RADIO BOOK BIBLIOGRAPHY.**

Handsomely bound in RED and GOLD

The RADIO DATA BOOK is a work of complete authority, prepared by engineers with many years of practical experience. They have been assisted by the Boland & Boyce staff of editors skilled in preparing electronics manuals for the U. S. Signal Corps for many years. These men have worked for several years gathering material for this book... all the knowledge of radio principles and operation... all the statistics... all the newest developments in electronics... every possible angle and detail. Eighteen months were spent digesting this material into the most concise, the clearest, and the most readable form. The result is this invaluable manual... The RADIO DATA BOOK. Whether you use this book for general reference, for scientific instruction, or for education, one thing is certain—the practical help, the daily usefulness you will derive from it will prove to be worth many, many times its astonishingly low price!

Advanced Sale... first printing, Only 10,000 available... To make sure to get your RADIO DATA BOOK, mail your order **NOW!**

12 complete books in one only \$5.00! Less than 42c per book!

**MAIL THIS COUPON TODAY!**

**BOLAND & BOYCE INC., PUBLISHERS**  
460 BLOOMFIELD AVE. MONTCLAIR 3, N. J.

Please send me a copy of

THE RADIO DATA BOOK Enclosed is \$5.00.

NAME .....

ADDRESS .....

CITY ..... ZONE .....

STATE .....

**BOLAND & BOYCE INC., PUBLISHERS**

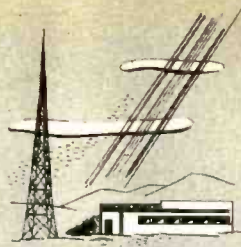

RADIO STATION STANDBY

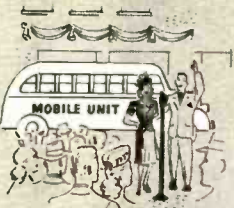

MOBILE RADIO UNITS



GEOPHYSICAL SURVEY

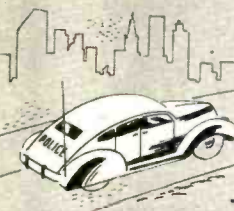

MUNICIPAL SIGNAL STANDBY



RAILROAD RADIO

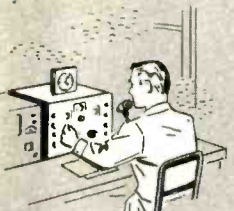

AMATEUR RADIO



"SPOT" RECORDING

# A.C. OR D.C. POWER

## PORTABLE, STANDBY OR STATIONARY for Electronics Uses

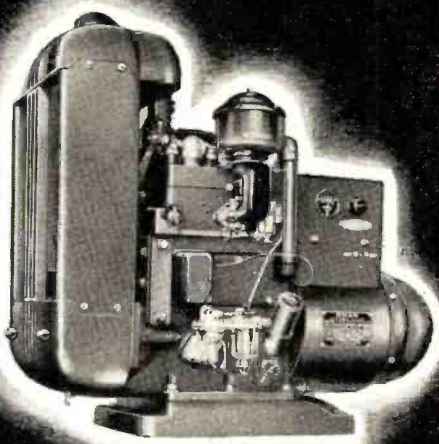

**O**nan Electric Plants are completely self-contained, dependable power units built in a wide range of sizes and standard voltages.

Lightweight, one or two-cylinder, air-cooled models offer the maximum in portability for many applications. Portable A.C. models—350 to 3,000 watts; portable D.C. models—600 to 5,000 watts.

Although widely used for intermittent service as standby units, Onan two, four, and six-cylinder water-cooled plants are built for continuous heavy-duty operation . . . stationary or mobile. A.C. models—3 KW to 35 KW; D. C. models—3.5 KW to 10 KW.

WRITE FOR FOLDER

ONAN Electric Plants are available in many sizes and models. ALTERNATING CURRENT: 350 to 35,000 watts in all standard voltages and frequencies. DIRECT CURRENT: 600 to 10,000 watts, 115 and 230 volts. BATTERY CHARGERS: 500 to 3,500 watts; 6, 12, 24 and 32 volts.

**D. W. ONAN & SONS INC.**

4787 Royalston Ave.

Minneapolis 5, Minn.



are ground to comparatively low frequencies. The feeder lines are low impedance four-wire feeders but the design of the antenna varies according to requirements. "The highly directional antennas are four-bay, four-stack with reflectors, and the broad beamed arrays consist of three stacked Krauss dipoles," Mr. Blake-more explains.

The RCA transmitters are of similar design using high level modulation, and are associated with similar antennas systems.

The Studio Center is equipped to provide live transmission or recorded programs and any compromise between the two. Radio SEAC's suite of studios is located at 191, Turret Road, opposite the Town Hall in Colombo.

"Interested SEAC listeners who find themselves at any time passing through or stationed in Colombo are most welcome to come in and be conducted over the premises," Mr. Blake-more invites.

"The technical problems involved in providing worthwhile broadcast entertainment over such a wide area as South East Asia are quite complex," Mr. Blakemore comments. "Although advantage can be taken of the very favorable propagation conditions in areas of similar latitude, the rapidly changing ionospheric conditions when beaming transmissions to northern latitudes must constantly be watched. The target area for the main transmissions is included roughly in an arc from Karachi in the northwest to Japan in the northeast and Singapore, Sumatra, and Java. To cover this area adequately, quite a number of high-power transmitters would normally be required, using various frequencies, as the propagation conditions change quite quickly throughout the day, and the static levels are high owing to climatic conditions. A compromise between the use of high-gain arrays and the provision of broad coverage must therefore be arranged.

"The ideal arrangement would be to have a number of high-power transmitters with high-gain antenna systems so arranged to cover the whole area," according to Mr. Blakemore. "The advantage of this arrangement becomes obvious when it is realized that with a high-gain antenna system the signal strength in the United Kingdom may be many times stronger than the present signal in Singapore, although the distance is almost five times as great. Were our transmissions concentrated on specific areas by using the multi-beam system, there is little doubt that a good signal could, at all times, be maintained, throughout the service area."

The frequencies at present allotted for the use of Radio SEAC are 3.390 to 3.395 in the 88-m. band; 6.075 in the 49-m. band; 9.520 in the 31-m. band; 11.770 in the 25-m. band; 15.120 in the 19-m. band; 17.770 in the 16-m. band; and 21.62 in the 13-m. band—five of which are now constantly in use at various times of the day, others being

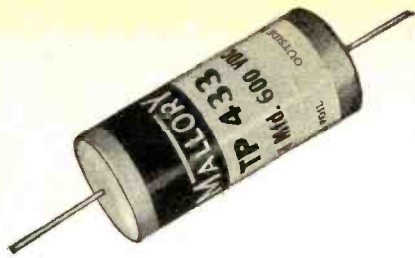

**PAPER**

**MICA**

**ELECTROLYTIC**

**CAPACITORS**

## MALLORY Precision Quality is Built in All Three

Service jobs that don't kick back are the ones that make a profit for you. When you use Mallory capacitors in your service work, you use capacitors *that don't kick back*. That's true whether the job calls for paper, mica or electrolytic capacitors.

Most servicemen know the big things behind Mallory capacitor quality. But there are many extra little things, too, that contribute to their life, uniformity and dependability.

Raw materials, for instance, that are held to an impurity level of less than one-half a part per million. Manufacturing techniques that prohibit human hands from even touching the capacitor cartridges. These are examples of the little things that make a world of difference in the final product. No wonder so many radio servicemen say:

*You Expect More and Get More . . . from Mallory*

**P. R. MALLORY & CO. Inc.**  
**MALLORY**

VIBRATORS . . . VIBRAPACKS® . . . CAPACITORS . . . VOLUME  
CONTROLS . . . SWITCHES . . . RESISTORS . . . FILTERS  
. . . RECTIFIERS . . . POWER SUPPLIES. ALSO MALLORY  
DRY BATTERIES, THE ORIGINAL MERCURY BATTERIES.  
®Reg. U. S. Pat. Off.

**APPROVED PRECISION PRODUCTS**

**P. R. MALLORY & CO., Inc., INDIANAPOLIS 6, INDIANA**

# Make more money with more to sell!

## THE COMPLETE, NEW '47 LINE

"It makes a big difference to have a complete line that meets every sales situation in the community," say Stromberg-Carlson Sound Equipment dealers.

The complete line is one great advantage, but here are more! The Stromberg-Carlson name stands for extraordinary designing, engineering and manufacturing skills. It has a sound reputation for customer acceptance. Stromberg-Carlson products have proved their profit-making qualities with scores of satisfied dealers.

Today, the widening sound equipment market welcomes the newest of Stromberg-Carlson scientific advances and the latest modern developments that make the line more complete than ever before. Why not inquire about a dealership? A limited number are still available.

*Here are a few typical products*

**PORTABLE SOUND SYSTEM, MODEL PS32**

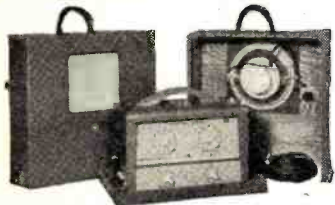

Portable system in a three-section, compact case. 15 watt amplifier with one phonograph and two microphone inputs, two heavy duty Alnico V reproducers, and 25 feet of durable cord with connectors attached. One case acts as the reproducer receptacle for connecting in cascade. Underwriters approved.

**AMPLIFIER, MODEL AU 35**



One phonograph and three microphone high impedance inputs, separate bass and treble controls, 50 watt divided output with separate master volume control. Additional amplifier jack for tandem operation. Hum adjuster, resistor board construction and rugged copper plated steel chassis. Underwriters approved.

**AMPLIFIER, MODEL AR 37**

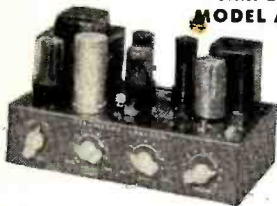

Two input jacks, one provides equalization network for crystal pick up, the other may be bridged across 500-600 ohm circuits, without change in level. Treble attenuation and boosts, bass boost, bass compensator volume control give the finest in record and wired-music reproduction.

**SOUND SYSTEM, MODEL SS 750**

A completely pre-engineered system. Incorporates AM-FM radio tuner, record changer, controls, and 90 watts of audio-power divided into four output circuits. Wired for optional remote control turret. Rugged all-metal cabinet with glacier-grey finish. Underwriters approved.

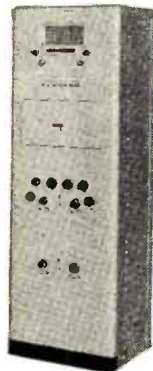

**STROMBERG-CARLSON**

STRAIGHT-LINE



COMMUNICATION



brought into service as varying conditions demand.

### Schedules

Normal schedules of *Radio SEAC* are:

Main Program—1930\*-1200, 6.075, 9.520, 3.395; 1930-2300, 2330-0500, 0700-1200, 15.120; 2300-0730, 1100-1200, 17.770. On Saturdays, 0830-1200, BBC sports and music are carried on 17.770, 3.395. On Sundays, the Main Program terminates at 1115, and the special transmission intended as a link between the Forces out East and their people at home, is directed to the United Kingdom, 1130-1330, on 15.120; various other frequencies parallel, irregularly; recently, 17.770 has been reported in dual to Britain, while 9.520 and 6.075 have been directed to India and East Asia; about 7.185, formerly used in the United Kingdom (Sunday) beam, may be used again on occasion. (Since Britain has turned back the clock by one hour, it is possible that *Radio SEAC's* Sunday beam to the British Isles may be heard one hour later, that is, 1230-1430.) Daily news bulletins are scheduled for 2000, 2200, 0030, 0300 (BBC), 0600, 0730, 1000 (Radio Newsreel from BBC), and 1100 (BBC).

Indian Forces' Program—2300-2330, 0500-0700, 15.120.

Listed recently as special broadcasts are—daily, except Sunday—relay of BBC news items from London papers at 0700-0710, and Forces Educational Broadcast, 0710-0730, 17.770, 6.075.

Station officials point out that "these schedules are subject to change, of which the only warning will be preliminary microphone announcements."

The station, originally a SACSEA Unit, is now operating under the control of the Director of Army Welfare Services, the War Office (A.W.S.S.), London. The station director, Wing Commander A. E. Smith, is responsible to the Director of A.W.S.S. for the detailed running of the station, and the station's adherence to the policy laid down. A committee representing all three Services—Army, Navy, and Air Force—meets periodically in Singapore to review the activities of *Radio SEAC* and to coordinate points raised by the various areas served.

Broadcast policy of *Radio SEAC* is: "Entertainment plus news, and a link with home."

Average mail from listeners is 8000 letters a month, most of them being, naturally, for requests. Officials say "the closest attention is paid to complaints (which are happily few) and all suggestions received. Reception reports arrive from all parts of the world—Sweden, oddly enough, sends most from Europe—and all are acknowledged. We modestly cannot think why, but there are regular listeners to *Radio SEAC*, incidentally, in every city in the United States." (The station)

(Continued on page 112)

\* Unless otherwise indicated, time herein is expressed in American EST on a 24-hour clock basis; add 5 hours for GCT. "News" herein refers to newscasts in the English language.

**RADIO NEWS**



**Raise An Effective Antenna  
in TEN MINUTES!**

*De Luxe*  
**GROUND PLANE  
ANTENNA**

Ground plane antennas are particularly good for increasing signal strength to other vertically polarized antennas such as used on mobile equipment. Also because of the low angle of radiation, it is quite effective for distance work.

The antenna consists of five sectional elements of copper plated steel tubing. The vertical element is electrically a quarter wave in length or about 8' for the 10 meter band. It is mounted on a large ceramic insulator which feeds through the metal horizontal element support. The lower end of the vertical element terminates with a coaxial cable connector so it is only necessary to connect a suitable length of RG8U, or other low impedance coax cable, to your transmitter.

- Easiest of all antennas to put up
- Low angle of radiation
- No tuning problems
- Built to withstand weather
- Requires a minimum of space
- Low priced

The antenna is shipped complete with a strong steel chain clamp assembly that may be mounted on a chimney, tree, mast or any vertical or horizontal support.

The Ground Plane Antenna is made to withstand extreme weather conditions. One of the nation's leading antenna manufacturers built them to rigid Army standards at a cost of several times our low price.

Ground Plane Antenna for 10 meter operation  
**\$12.50**

Ground Plane Antenna for 2 meter operation  
**\$12.50**

(Elements may be cut for any frequency between 28 and 152 Mc.)

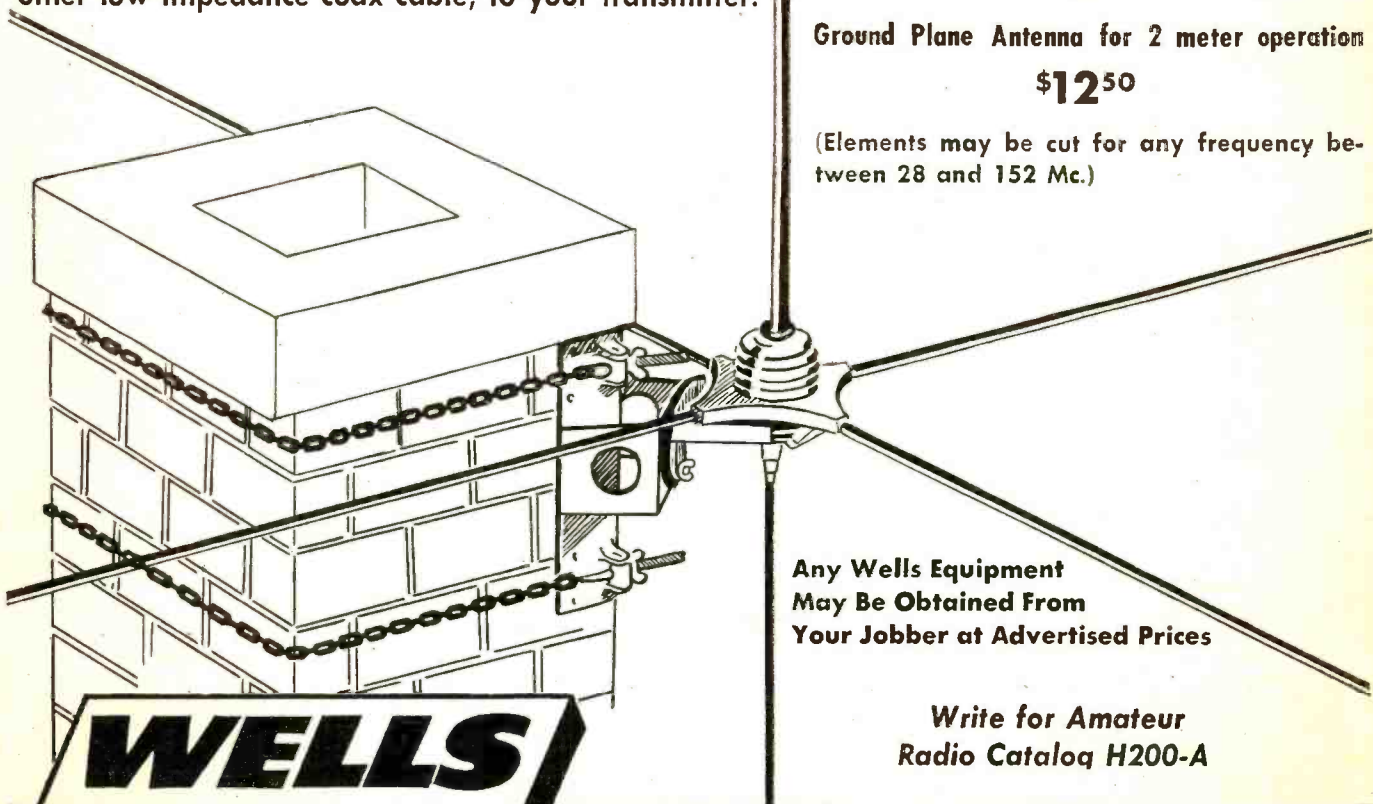

Any Wells Equipment  
May Be Obtained From  
Your Jobber at Advertised Prices

Write for Amateur  
Radio Catalog H200-A

**WELLS  
SALES, INC.**

320 N. LA SALLE ST., DEPT. R-9, CHICAGO 10, ILL.



### BC-348 COMMUNICATIONS RECEIVER

This receiver will give outstanding performance wherever used. 6 bands, 200-500 Kc. and 1.5-18 Mc. Two stages RF, three stages IF, BFO, Crystal Filter, Manual or AVC. Complete with tubes and 24 V. dynamotor. Guaranteed. In excellent condition.

Price ..... \$47.50

BC-348, 110 V. AC Power Supply, including simple conversion instructions, complete with 6x5 tube..... \$9.95

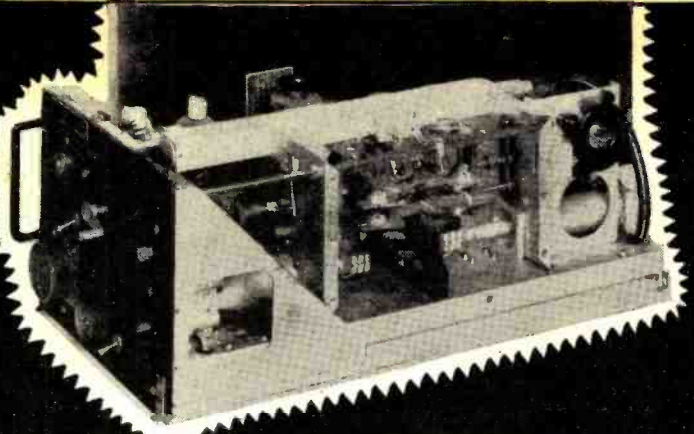

### RADAR TRANSMITTER T-39/APQ-9.

Contains many excellent parts for the VHF experimenter such as a cavity oscillator using 2-RCA 8012 tubes rated at full output to 500 Mc. Tubes are forced air cooled by 24 V. DC motor, which is easily converted for 110 V. AC operation. Other valuable parts such as a pair of 807's, 2-6AC7, 1-931 and 1-6AG7 tubes; ceramic switch, potentiometers, gears, revolution counter, etc.

PRICE..... \$19.50



### TURBO AMPLIFIER

Used for parts—shipped complete with the following tubes

- 2.....7C5's
- 1.....7Y4
- 1.....7F7

Price ..... \$1.25 ea.



### TELRAD 18-A FREQUENCY STANDARD.

Checks signals in the range of 100 Kc. to 45 Mc. with a high degree of accuracy. Self-contained power supply is 110, 130, 150, 220, and 250 V. 25-60 cycle AC. Complete with tubes, dual crystal, and instruction book. Brand new.

Price..... \$24.95

### PANEL METERS — BARGAINS

Brand New in Original Boxes

- |  |        |
|--|--------|
| 1. 0-500 Ma. DC, 3 1/2" Westinghouse.....  | \$3.50 |
| 2. 0-300 Ma. DC, 2 1/2" Westinghouse.....  | 2.50   |
| 3. 0-5 Amp. RF, 3 1/2" Westinghouse.....   | 4.50   |
| 4. 0-7.5 Volts AC, 3 1/2" Westinghouse.....                                      | 3.50   |
| 5. 0-3 Amp. RF, 2 1/2" Westinghouse.....   | 3.50   |
| 6. 0-10 Ma. DC, 0-300 Ma. DC—Combination, 2 1/2" Westinghouse or GE.....         | 3.00   |
| 7. 0-2 V FS Rect. Type 2000 Ohm/V., Volume Level Meter, 2 1/2" Westinghouse..... | 3.00   |

### BC-375-E TRANSMITTER, \$17.50

Transmitter only, including tubes and one tuning unit of your choice. BC-375 Transmitter Tuning Units in aluminum cases.

- |                                     |            |
|-------------------------------------|------------|
| TU-5B and TU-10B.....               | \$3.95 ea. |
| TU-6B, TU-7B, TU-8B, and TU-9B..... | 2.95 ea.   |
| TU-26-B.....                        | 2.45 ea.   |
| Antenna Tuning Unit, BC-306-A.....  | 3.95       |
| Dynamotor PE73-C.....               | 4.95       |

### BC-357 MARKER BEACON RECEIVER

Ideal for controlling remote circuits for model aircraft, boats, etc. Operates from 75 mc. Signal easily altered to 2 meter band. Tubes used and included: 1-6SH7, 1-6SL7GT, 1-12SN7GT Also sensitive relay. Circuit diagram included inside case. Size 5 3/8" x 3 3/8" x 5 1/4" For 24 V DC operation. Complete as shown.

Price..... \$1.95

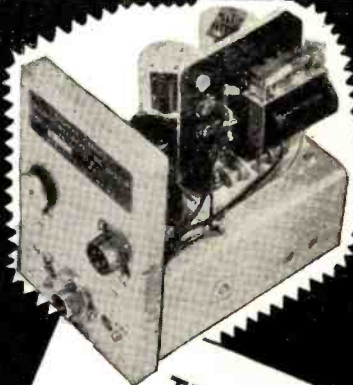

TERMS  
CASH  
WITH  
ORDER

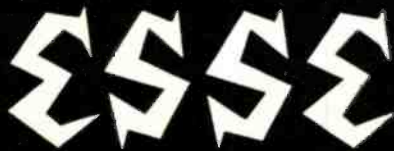

Radio Company

130 W. New York St. Indianapolis 4, Ind.



# ESSE Specials!

UNLESS OTHERWISE SPECIFIED, MERCHANDISE HAS BEEN REMOVED FROM SURPLUS AIRCRAFT AND IS SOLD AS USED.



### RECEIVER AND TRANSMITTER RT-34/APS-13.

Ideal for conversion for amateur mobile use on VHF frequencies. These units are very clean and come complete with dynamotor for 28 V DC input, 285 V. 60 Ma. output, 9-6AG5, 5-6J6, 2-2D21 and 1-VR-105 tubes, co-axial connectors, potentiometers, relay, etc.

PRICE.....\$11.75

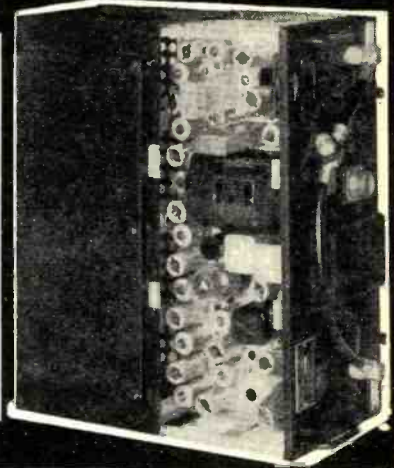

### R-54/APR-4 RECEIVER.

Complete with Tuning Unit TN-17/APR-4 for 74-320 Mc. band. Operates from 115 V 60 cycle AC source.....\$75.00

Extra Tuning Unit-18/APR-4 for 320-1,000 Mc. band.....\$17.50

### ARR-1 RECEIVER—34-58 Mc.

Ideal for mobile receiver or converter on 2 or 6 meter band. Contains 4-954 type acorn tubes, connectors, etc.

PRICE . . . . . \$7.95

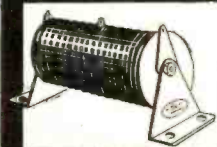

### BL-SELENIUM RECTIFIER TYPE 23751

A must for the radio man for the much needed 110 V. DC source. 110-120 V. AC input. 110-135 V. DC output at .75 amp. Connect in parallel for higher current requirements. Size 3 1/2 x 2 5/8 x 1 3/4 inches.

PRICE—New.....\$1.65 ea.

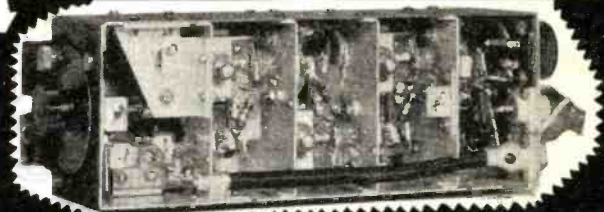

### BC-966-A IFF.

Contains following: Pioneer Gen-E-Motor, 18 V. input, 450 V. 60 Ma. output; 65W-40 ohm resistor; 1 Mfd. 1000 V. condenser; 4-lo-current relays; 4-7193, 7-6SH7, 3-6H6; Eclipse Carbon pile type voltage regulator, etc.

PRICE.....\$8.75

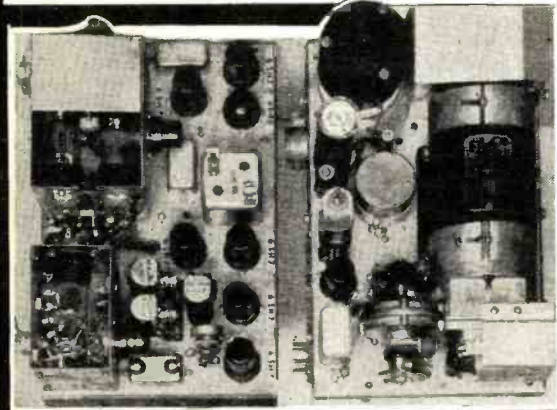

### COLLINS ART-13 TRANSMITTER

Complete with dynamotor and tubes.....\$88.50

### BEAM ROTATING MOTORS

As described in August Radio News. Conversion data included.

PRICE.....\$14.95  
Converted.....\$37.50

### NAVY TDE-2 TRANSMITTERS

Brand new, including tubes.....\$300 each

### HS-30 STETHOSCOPE TYPE HEADPHONES

Lightweight, comfortable to use.

New.....\$1.75 pr.



### INTERVALOMETER

Used to release bombs at pre-determined intervals—adaptable for use as a timing device in photography, etc.

Price.....\$1.75 ea.

**TERMS  
CASH  
WITH  
ORDER**

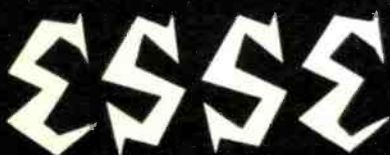

## Radio Company

130 W. New York St. • Indianapolis 4, Ind.

# OPPORTUNITY FOR RADIO MEN!

Think of it! The average American home has at least 11 electric motors in it. Large homes have from 15 to 25—in washers, record players, oil burners, clocks, fans, mixers, refrigerators, etc. No wonder, then, that motor repair is such a good, well-paid business! It's a real "natural" for radio men to learn—and our big new book, **ELECTRIC MOTOR REPAIR** (see below) teaches you fast—teaches you right! Send coupon today!



**I'll Make it  
EASY for you  
to LEARN  
PROFITABLE  
ELECTRIC MOTOR  
REPAIR...**

**... ONLY \$5 FOR  
THE COMPLETE  
553-PAGE COURSE!**

**ELECTRIC MOTOR REPAIR**, a big book by the publishers of famous Ghirardi Radio-Electronic books is a gold mine for radio men who want to expand along logical, profitable lines in an uncrowded field. Based on this big book alone, you can train for prompt, profitable service on practically ANY TYPE OF MOTOR IN COMMON USE—from fractional horsepower motors in home appliances, to the larger industrial motors. It tells exactly how to do everything from making simple adjustments and repairs to complete rewinding. Covers AC and DC motors, synchronous motors and generators and BOTH mechanical and electrical motor control systems.

### IT PAYS TO SPECIALIZE IN "SOMETHING DIFFERENT"

Every step of the work is explained simply as A-B-C, both in text and by more than 900 specially prepared diagrams and illustrations. No guesswork! Each phase of motor repair is clearly shown so there can be no mistaking as to what should be done and why. Quick reference guides show step-by-step how to handle specific jobs. When a motor comes in for repairs, just turn to **ELECTRIC MOTOR REPAIR** and see what to do. It's an ideal book, either for beginners or for bench use in busy shops!

Unique Duo-Spiral Binding divides book into two sections with text on one side, pictures on the other. Lies flat on the bench. Both text and related illustrations are visible at the same time.

### MONEY-BACK GUARANTEE

Send coupon now! Practice from **ELECTRIC MOTOR REPAIR** for 5 full days—**AT OUR RISK**. Actually fix motors for yourself and friends. Then, if not more than satisfied, return book to us and **EVERY CENT OF YOUR MONEY WILL BE CHEERFULLY REFUNDED**. No questions asked!

**"BORROW" IT FOR  
5 FULL DAYS!  
NO RISK COUPON mail today**

Dept. RN-97, Murray Hill Books, Inc.  
232 Madison Ave., New York 16, N. Y.

Send me a copy of **ELECTRIC MOTOR REPAIR** for which I enclose \$5 (\$5.50 foreign); or I send C.O.D. and I will pay postman \$5 plus postal charges. If I then decide I don't want the book, I'll return it within 5 days of receipt and you guarantee to refund my \$5 and no questions asked!

Name.....

Address.....

City & Zone..... State.....



# CIRCUIT PAGE

(FOR PARTS LISTS SEE PAGE 84)

RADIO NEWS, SEPTEMBER, 1947

BELMONT MODEL 5P19

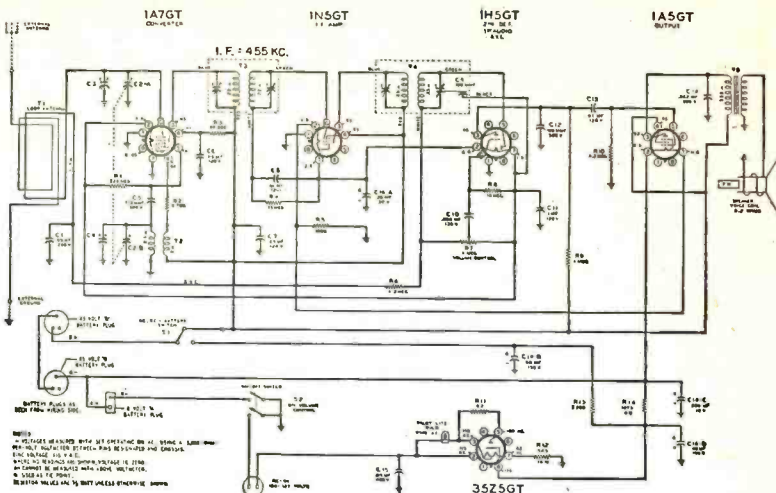

RADIO NEWS, SEPTEMBER, 1947

CROSLY MODEL 56FC

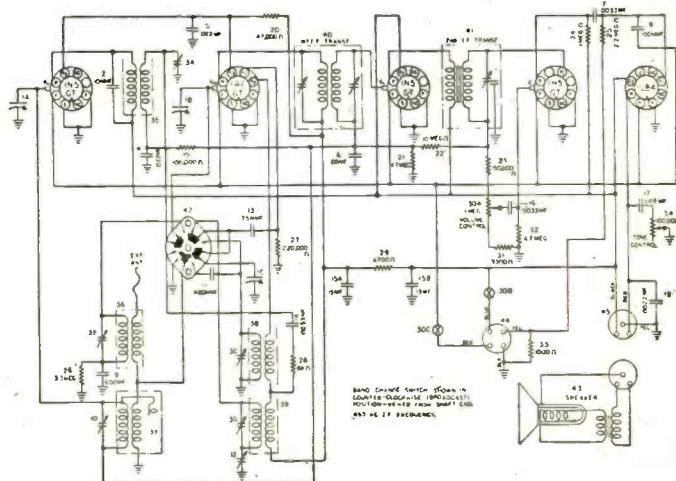

RADIO NEWS, SEPTEMBER, 1947

GAROD MODEL 5A1

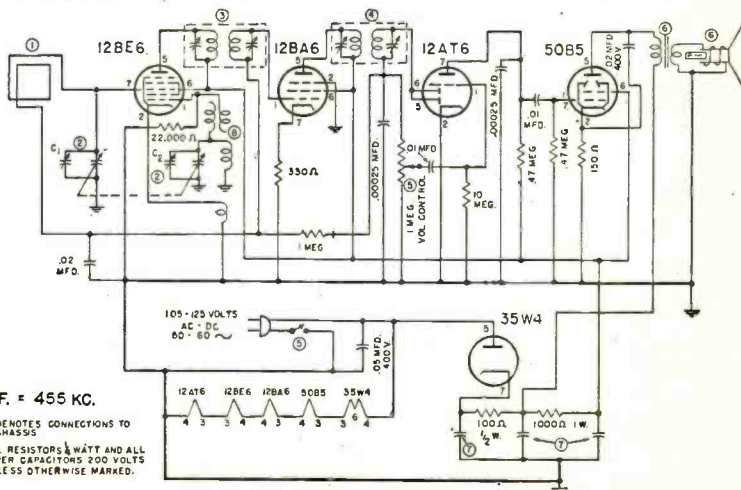

Here, and on following pages, are circuit diagrams and parts lists of many new postwar radio receivers. Radio News will bring to you other circuits as quickly as possible after we receive them from manufacturers.

RADIO NEWS, SEPTEMBER, 1947

ADMIRAL MODELS 7T06, 7T12

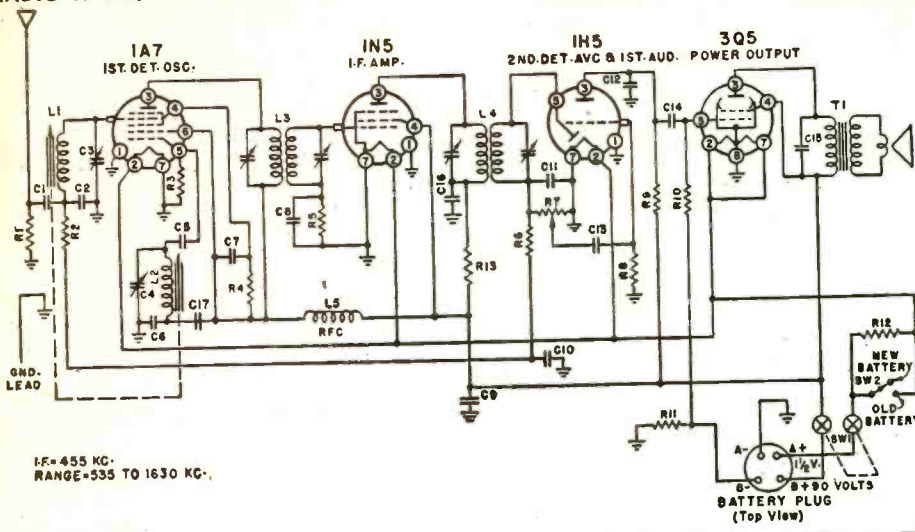

I.F. = 455 KC.  
RANGE = 535 TO 1630 KC.

RADIO NEWS, SEPTEMBER, 1947

ARVIN MODELS 555, 555A, 552N, 552AN

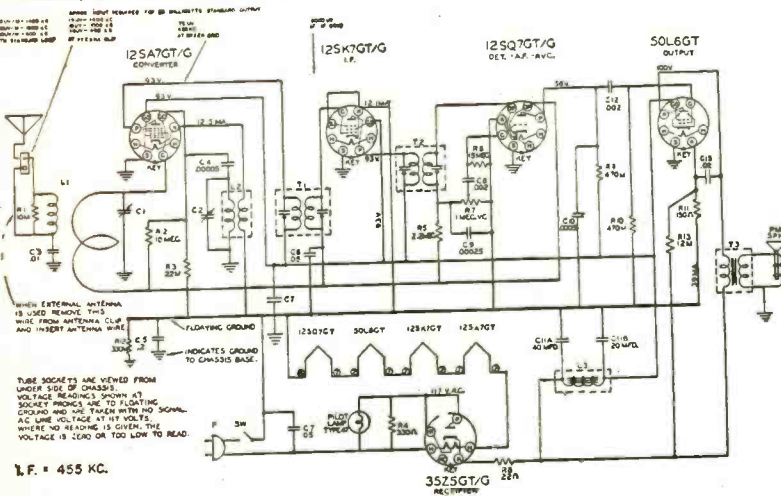

I.F. = 455 KC.

RADIO NEWS, SEPTEMBER, 1947

EMERSON MODELS 507, 509, 518, 522, 535  
CHASSIS MODEL 120005 PART NO. 950004

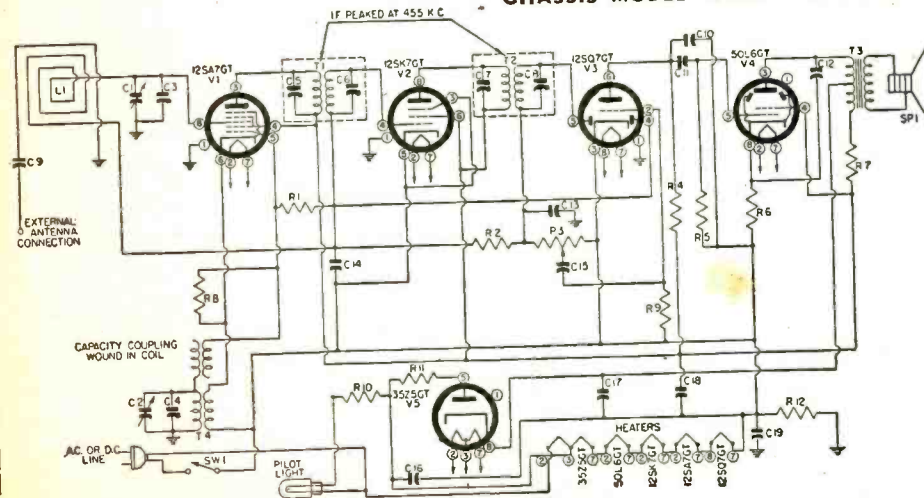

September, 1947

FREE! SEND FOR IT

# ALLIED'S 164-Page RADIO CATALOG

Save on Everything in Radio!



Here is everything in radio—in one BIG, easy-to-use book—at prices that save you money! New radios, phonos, complete PA equipment, test instruments, Ham equipment, thousands of parts, tubes, tools, books, diagrams, kits—everything for the experimenter, builder, serviceman, amateur. Send today for this COMPLETE Buying Guide. Get everything you need—save at ALLIED, Radio's expert, dependable supply source.

## RADIO BUILDERS!



### Low-Cost 5 Tube Kit

Complete with Cabinet, Loop Antenna & Tubes  
The first ultra-modern 5 Tube AC-DC Superhet kit at so low a price!

Here's what you get—full broadcast coverage (550-1600 Kc); built-in loop antenna; latest 5° PM dynamic speaker; handsome walnut plastic cabinet. Easy to build; no special tools required. Sockets are riveted in place; just assemble, wire and slip into cabinet. Outstanding power and tone quality. Highest grade components. Complete with all parts, tubes and full instructions. Nothing like it at the price! Shipping weight, 10 lbs. No. 83-275. Complete. **ONLY 1495**



More than 10,000 items—Complete lines of all leading makes. Largest stocks of hard-to-get parts. Lowest money-saving prices. Get everything you need in Radio from ALLIED!



Public Address—entirely new line—new styling, new design features. Packaged Ready-to-Use Sound Systems; everything in amplifiers, speakers, mikes, intercom and recording.



Amateur Gear—immediate delivery on latest communications receivers. Time payment plan; trade-ins accepted. Headquarters for all ham and experimenters' needs.

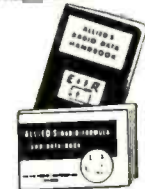

### Handy Radio Books

Radio Formulas and Data Dictionary of Radio Terms  
Radio Circuit Handbook  
Radio Builder's Handbook  
Simplified Radio Servicing  
Radio Data Handbook  
ALL SIX BOOKS No. 37-799 . . . \$1.00  
Parallel Resistance and Series Capacitance Calculator, No. 37-960 . . . 25c  
R-F Resonance and Coil Winding Calculator, No. 37-965 . . . 25c

## ALLIED RADIO

ALLIED RADIO CORP.  
833 W. Jackson Blvd., Dept. 1-J-7, Chicago 7, Ill.

Send FREE 164-Page Catalog }  
 Send Kit No. 83-275 } \$ ..... enclosed  
 Send 6 Books No. 37-799 }  
 Send Calculator No. . . . .

Name .....  
Address .....  
City ..... Zone ..... State .....

# FALL LEONE SPECIALS

**PHONO MOTORS!**—Twin-coil 110V AC, quiet rim-drive. Fan cooled. With deep-locked 9" turntable. . . . . \$2.95  
**DYNAMOTOR**—DM-36D 28V DC to 220V DC @ 80ma. With complete filter system. 6 1/2" x 3 1/2" x 3". Shipping weight 7 lbs. . . . . 2.49  
**LEATHER CARRYING CASES.** Brand new (from Weston #689 ohm meter). By black cowhide, velvet lined. Perfect for meters, cameras, binoculars, etc. Snap lock & key; 24" carrying strap. 6" x 4 3/4" x 2 1/2" . . . . . 1.49  
**SPECIAL!**—GIANT "GRAB-BAG" RADIO PARTS KIT. Real buy for the Serviceman, Amateur or Experimenter. 15 FULL POUNDS of resistors, condensers, transformers, wire, speaker repair parts, hardware, etc. . . . . \$1.95  
 etc. An amazing value at . . . . .

**UTC "OUNCER" INPUT TRANSFORMERS.** 1/4" x 3/16" Dynamic mlke or low impedance pick-up to grid. . . . . \$0.49  
 12 for 5.00

- SERVICEMEN'S KITS**
- # 1—R.F. Antenna & Osc. coils; 10 asstd. \$0.98
  - # 2—Speaker Cones; 12 asstd. 4" to 12" moulded & free-edge (magnetic incl.). Less voice coils & trimmers. . . . . 2.00
  - # 3—MOULDED BAKELITE CONDENSERS; 50 asstd. .00001 to .2mfd. 200-600V. Clearly marked. . . . . 2.95
  - # 4—TUBULAR BY-PASS CONDENSERS; 50 asstd. .001 to .25mfd. 200-600V. Standard brands. . . . . 2.49
  - # 6—Dial Scales; 25 asstd. airplane slide-rule (acetate & glass included). . . . . 2.98
  - # 7—Eucuchon Plates; 25 asstd. airplane slide-rule & full-vision types. . . . . 2.95
  - # 8—Knobs; 25 asstd. set screws, springs & push-button types. . . . . 1.00
  - # 9—Wafer Sockets; 12 asstd. 4 to 7 prongs. . . . . .25
  - # 10—Voltage Dividers; 10 asstd. standard, multi-tapped. High wattages incl. . . . . 1.98
  - # 11—Shield Cans; 15 asstd. or coils, tubes, transformers, etc. . . . . 1.00
  - # 12—Mica Padders & Trimmers; 15 asstd. incl. multiple & ceramic base types. . . . . .69
  - # 14—Volume & Tone Controls; 10 asstd. wire-wound & carbon. Less switches. . . . . 1.49
  - # 15—Wire-Wound Resistors; 15 asstd. ohmage, 5 to 20 watts. . . . . .98
  - # 16—I.F. Coils; 6 asstd. including shielded & slug tuned. Peaks unmarked. . . . . 1.25
  - # 17—Dial Windows; 12 asstd. flat & moulded acetate and glass. . . . . 1.29
  - # 20—SPEAKER REPAIR KIT. A real time & time saver. Contains: 25 asstd. paper rings, 10 spiders, 25 asstd. voice coil forms, 3 yds. felt strips, 20 chamois leather segments, kit of 18 shims & tube of speaker cement. . . . . 2.49
  - # 23—RADIO CEMENT & SOLVENT. Each of all-purpose cement & thinner. With brush. . . . . .69
  - # 24—Shaft Extenders, Reducers, Couplings; 10 asstd. popular types used in servicing. . . . . 1.29
  - # 26—SPEAKER CONE RINGS; 50 asstd. cardboard rings in popular sizes, 3" to 12" . . . . . 1.49

**HEADPHONES** (Army HS-28) 8000 ohms imp. Leather covered, adjustable. With PL-54 plug. \$1.25  
 Rubber phone cushions for above, per pair. . . . . .20  
 PL-54 plug & 13' tipped double cord. . . . . .19  
 JK-26 ext. jack for PL-54. . . . . .23

**RADIO HARDWARE TREASURE.** An indispensable assortment of approx. 1000 screws, nuts, lugs, washers, etc. . . . . \$0.49

**TUBES:** Perfect condition, but not in sealed cartons. Every tube guaranteed 90 days.  
 # 20, 26, 27 or 56 . . . . . \$0.29  
 # 42, 45, 75, 77, 78, 80, 89, 5Y3, 6H6 or 6K7 . . . . . .39  
 # 35, 37, 39, 76, 84, 6AB, 6C5, 6F5, 6SA7, 6SK7, 2SA7 or 2SK7 . . . . . .49  
 # 1A7, 8A3, 8U5, 7A7, 7C5, 7G6, 7Y4 or 80 . . . . . .59  
**TUBE CARTONS:** Plain white. GT size 1 1/4" sq. x 3 1/4". Per 100. . . . . 1.25  
 Medium size (1 1/4" sq. x 4 3/4"). Per 100. . . . . 1.49  
**EXPERIMENTAL TUBES.** 20 asstd. receiving types for testing, research, etc. Fill tested. . . . . 1.00

## ALNICO MAGNETS

- # 1—Bar, 3/4" x 5/16" x 1 1/2". . . . . \$0.59
- # 2—Bar, 1/2" x 1/4" Max. length 3". Per inch. . . . . 1.12
- # 3—Heavy duty bar, 2 1/2" x 1 3/8" x 3/16". . . . . .98
- # 4—Face 3/4" x 5/8" x 3/16" high. . . . . .39
- # 5—Polished, 7/8" x 9/16" x 3/16" high. . . . . .35
- # 7—Face 1/2" x 1/4" x 3/16" high. . . . . .10
- # 9—ALNICO V. h'shoe, poles 9/16" dia. 1 1/2" high. . . . . .98
- # 11—H'shoe, poles 1 1/16" O.D., 2 1/4" high. . . . . 1.29
- # 14—Pishd. bar, 3x1 1/4" x 7/8" (magnetized lengthwise, wide or narrow sides). . . . . 1.29
- # 16—Flat bar, 1 7/8" x 1 5/16" x 5/16" thick. . . . . .49
- # 18—Round bar, 1 7/8" O.D. x 3/16". . . . . .19
- # 22—Rnd bar, Pishd. 5/8" O.D. x 1 1/2". . . . . .39
- # 24—Rnd bar, Pishd. 3/4" O.D. x 4 1/4". . . . . 1.25
- # 26—Rnd bar, Pishd. 3/4" O.D. x 2". . . . . .49
- # 28—Circular, Pishd. 1 7/8" O.D., 1 3/16" I.D. 1 1/2" deep. . . . . 1.95
- # 30—H'shoe, facing 3/4" sq. poles 3/4" gap, 2 1/4" high. . . . . .89
- # 31—H'shoe, extremely powerful. Poles 1 5/16" x 1 3/16" x 2" high. Polished. . . . . 1.49

**PROMPT SERVICE ON ALL SPEAKER & PHONO PICK-UP REPAIRS**  
 Minimum Order \$2.00—20% Deposit Required on All Orders. Please Add Sufficient Postage. Write RN-8.

**LEONE RADIO CO.**  
 MAKERS OF CONES AND FIELD COILS  
 65-67 DEY STREET, NEW YORK 7, N.Y.  
 WORTH 2-0284-5  
 12,000 SQ. FT. OF RADIO PARTS

# What's New in Radio

## TV TUBE

The Tube Division of the General Electric Company's Electronics Department has announced the development of a new ten-inch cathode-ray electronic tube, the Type 10FP4, for use in television receivers.

Employing magnetic focusing and



deflecting, the new tube is designed with an aluminum-backed, direct-view screen. In addition to increasing the clarity, brilliance, and definition of the image, this aluminum backing prevents the development of ion spots and intercepts cathode glow, according to the company.

Maximum ratings of the 10FP4 include an anode voltage of 10,000 volts; grid No. 2 (accelerating electrode) voltage of 410 volts; grid No. 1 (control electrode) voltage of minus 125 volts.

Constructed with a small-shell, 7-pin duodecal base, the 10FP4 has an overall length of 18 inches and a maximum deflecting angle of 50 degrees.

Further information on this new Type 10FP4 may be obtained from the Tube Division, General Electric Company, Electronics Department, Schenectady, New York.

## 150 WATT TRANSMITTER

Production is under way at the Collins Radio Company plant in Cedar Rapids on the company's Model 32V-1, 150 watt amateur phone or c.w. transmitter.

Housed in a receiver-type cabinet,



the 32V-1 is complete including r.f. circuits, audio circuits, and power supply. Frequency control is variable by means of a permeability tuned oscillator. All r.f. circuits are ganged and are tuned by the frequency control knob, with exception of the output coupling net-

work. Bandswitching is employed in all stages.

Collins Radio Company, Cedar Rapids, Iowa will furnish complete details on this amateur transmitter to those requesting them direct from the company.

## SIGNAL TRACERS

Two new signal tracers, Model 250 and 200, have been added to the Precision Electronics, Inc. line of test equipment.

The Model 250 is a deluxe unit which incorporates a four-stage v.t.v.m., provides a gain of 12,000, and an input capacity of 3  $\mu$ fd. without detuning effects. The unit is a.c. operated from any 105-120 volt, 50 or 60 cycle line. The frequency range is from 20 cycles to 300 mc.

The standard Model 200 checks signals stage-by-stage in the r.f., i.f., and audio sections. It is similar to the deluxe unit with the exception of the v.t.v.m.

Details on either or both of these units may be secured by writing to Precision Electronics, Inc., 641-643 Milwaukee Avenue, Chicago 22, Illinois.

## PROFESSIONAL RECORDER

Robinson Recording Laboratories have announced a new professional



recorder which is the result of their eighteen years' practical experience and research in the field.

The recorder chassis is built on a heavy cast aluminum bedplate and features a cast-in control panel for VI meter, fader, and switches. The cutter carriage and pitch change box are of chrome plated aluminum. The cutter carriage is made in two types which will accommodate any existing type of recording mechanism. The standard type accommodates RCA, Presto and other popular small cutting heads. A second type of carriage is made for Western Electric wax cutters. A precise vertical vee-slide block permits accurate adjustment of cutting needle angle, accommodating all cutting needle lengths. The feed screw is 7/8" in diameter and the threads are precision ground. Five pitches are available by means of five levers, pro-



**FOR** *Television*

**FOR** *F.M.*



**THE WARD *Magic Wand* AERIAL makes any receiver work better**

Scientific tests prove that quality FM or Television reception is difficult, if not impossible, without a good outdoor aerial. So, don't blame your receiver if reception isn't up to par. Do install a Ward Magic Wand Outdoor Aerial and see for yourself the almost magical improvement that results.

These new Ward outdoor FM and television aerials are available in either straight or folded dipoles (reflector kits also available) for the 88 to 106 mc FM band, and the 44 to 88 mc television band. They do away with bothersome weak spots, and your set functions at full efficiency even on distant stations.

New foolproof design adapts easily to the requirements of each installation. Universal base permits mounting at any roof or wall angle. Sturdy vertical element revolves in base to easily orient dipole for maximum gain. Dipole is of corrosion-preventive aluminum, other parts weatherproofed inside and out. Ring provides for attaching guy wires. Sixty-foot polyethylene-insulated lead-in of 300-ohm colinear transmission line included. Standoffs of exclusive design guide transmission line down mast, and to receiver, minimizing capacity to ground and eliminating line reflections. Complete, step-by-step installation instructions included with each aerial.

Get your Ward Magic Wand FM or Television Aerial today, or mail the coupon below for free catalog and name of your nearest dealer.

**THE WARD PRODUCTS CORPORATION**  
1524 East 45th Street, Cleveland 3, Ohio  
**DIVISION OF THE GABRIEL COMPANY**

IN CANADA: Atlas Radio Corp., 560 King Street, W., Toronto, Ontario, Canada  
EXPORT DEPT.: C. O. Brandes, Mgr., 4900 Euclid Avenue, Cleveland 3, Ohio  
**September, 1947**

**ATTENTION DEALERS:**  
Powerful Ward national advertising in the Saturday Evening Post, and leading newspapers, now is educating over 33 million present (and future) owners of FM and television receivers to their need for Magic Wand Aerials. Write for free details on how you can best capitalize on this advertising in your locality.



**MAIL COUPON TODAY**

WARD PRODUCTS CORP.  
1523 East 45th Street  
Cleveland 3, Ohio

Please send me free catalog on Ward Magic Wand Aerials for FM and Television, and name of my nearest dealer.

NAME \_\_\_\_\_

ADDRESS \_\_\_\_\_

CITY AND STATE \_\_\_\_\_

**SILVER**

# AM PLUS FM 90 KC-210 MC



**OVERWHELMING ENTHUSIASM** greeted first shipments of Model 906 Signal Generator . . . most of which seem to have gone into manufacturers' laboratories, so good is it. Nowhere else . . . at any price . . . can you buy its equal. Check these features: eight ranges dial calibrated to 1% accuracy . . . 90 kc/170 mc. AM . . . 90 kc. 210 mc. FM . . . built-in 0/500 kc. FM sweep . . . variable 400 amplitude modulation . . . less than 1 microvolt to over 1 volt metered output . . . resistive and capacity-insulated output strays so low it's in the \$500.00 and up laboratory class. Yet price is only \$99.50 net.

## "VOMAX"

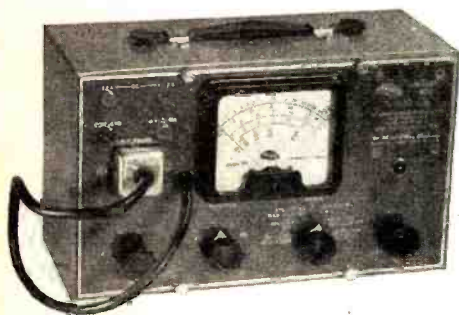

### NEW PENCIL-THIN R.F. PROBE

New "VOMAX" is equipped with new, pencil-thin, flexible 5-inch r.f. probe extension plus ground clip-lead. It will reach any point in the tightest midjet receiver . . . will even bend around corners! This exclusive new SILVER development maintains "VOMAX" as the finest, most complete meter you can buy . . .

Overwhelmingly, acceptance proves "VOMAX" to stand head and shoulders above any other meter — at any price. It is unbeaten . . . even by its copyists . . . for accuracy,

for d.c., a.c., a.f., i.f. and r.f. voltage ranges . . . as it is for current and resistance ranges . . . for frequency range . . . and for that astronomically high input resistance so necessary to effective AM, FM, and TELE receiver servicing. Price is still only \$59.85 net . . . r.f. probe extension kit \$35.

**NEW CATALOG.** Mail penny postcard for complete catalog, these and other SILVER top-dollar test instruments. They are the back-bone of modern servicing. New transmitters, receivers, exciter, MICROMATCH, prefuned frequency multiplier are amateur news! See them at your jobber.

OVER 36 YEARS OF RADIO ENGINEERING ACHIEVEMENT

*McMurdo Silver Co., Inc.*

1249 MAIN ST., HARTFORD 3, CONNECTICUT

viding 85, 100, 120, 130, and 140 lines per inch. Selection of outside in or inside out recording may be made instantaneously by means of a toggle lever. Another toggle lever changes the turntable speed from 78 to 33½ r.p.m.

A constant speed motor is suspended from the underside of the chassis. The chassis fits in two styles of steel cabinets, one for portable use and the other for operation in a fixed location.

Complete performance data on this recorder will be supplied by *Robinson Recording Laboratories*, 2022 Sansom Street, Philadelphia, 3, Pennsylvania.

### SIGNAL TRACER KITS

Students, servicemen, amateurs, and experimenters who like to build their own test equipment are being offered two new and complete kits of parts for assembling either a battery operated or an a.c. operated signal tracer by *Special Products Company* of Silver Spring, Maryland.

These kits contain parts identical with those used in the completed models offered by the company. All components are packaged in individual envelopes or are tagged for accurate identification by the assembler. Circuit diagrams, assembly pictorials, instructions for assembly, and an operating handbook are included with each kit.

The battery operated tracer kit is known as the model "Stab-Kit" while the a.c. operated kit is known as the "Stac-Kit." Information on either or both of these units will be furnished by *Special Products Company*, Silver Spring, Maryland, upon request.

### NEW AMPLICALL

*Rauland Corporation* of Chicago has announced a new type of intercom system, the "Amplicall."

Housed in a modern case of walnut plastic, this unit incorporates several new electronic developments which



provide versatile operation and economy of installation, according to the company.

The master station unit is available with or without handset (for completely private conversation). The unit features a visual-type busy signal, individual locking-type push-buttons for station selection, illuminated "on-off" volume control, plug-in cable connections, and a balanced line wiring system which prevents cross talk and reduces installation costs.

"Amplicall" systems are available  
(Continued on page 128)



# "TAB"

NEW GUARANTEED

ELECTRONIC PARTS

That's A Buy

USED S.C. & NAVY EQUIPMENT "TAB"  
 GTD 1-22 XTA CALIB SIG-GENERATOR  
 TOR. FREQ. METER. MONITOR. OP  
 110V/60cy complete Covers IF ranges FM  
 & TELEVISION. DUAL OSC. 80i5&45to  
 77mc's. 2nd,3rd&4th harmonics usable to  
 230mc's. SIX Tubes micro-Vermier dial  
 reads 1/10 div. Rugged Dsgn SPECIAL. \$45.00  
 NAVY SOUND POWERED TELEPHONES 9.95  
 SCR 522 COMPRISES BC624&625 RE-  
 CEIVER TRANSMITTER 100-156mc's  
 COVERAGE XTAL CONTROL XMITTER  
 MODULATED ISW OUTPT RCVR 10  
 Tubes. XMITTER 7tubes Complete with  
 data for Amateur use. 18.00  
 NAVY RBC RECEIVER 4 to 27 mc's 16  
 tubes BEST RCVR MADE SPECIAL. 75.00  
 BC1073A-VHF WAVEMETER SIG-GEN-  
 ERATOR OP 110VAC. Range 150-210  
 mc's/19 tubes can be converted to re-  
 ceiver SPECIAL. 24.95  
 CW3 RCVR NEW COMPLETE & Data for  
 Converting into Ham Rcvr. 14.50  
 CW&F3 Coils 5.1-10 or 9.4-16.5mc's. 2.70  
 AIRCRAFT AUTOSYNS AY-1&5/2BV/400  
 cy can be used 24V/60cy used gtd.  
 TWO for 3.95

GE THERMOSTAT adj 70to170°F/250V/25AMP \$3.95  
 WSTGHSE RECTIFIER FW 12V/2AMP. 3.95  
 WSTGHSE RECTIFIER CT 9V/0.2AMP. 1.49  
 IT&T SELENIUM RECT 110VDC/2.6AMP. 5.95  
 IT&T SEL RECT 6B8AV1, FW 85V/2.4AMP. 6.95  
 IT&T SEL RECT 6.5Vin/2.2V/1.5Amp. 1.49  
 BLOWER AIR 100cuftM 28VDC & AC Inpt. 4.95  
 BLOWER AIR SAME OPERATES 115VAC/60  
 cy. 5.95  
 VACUUM CONDRSR 50MMF/7500V GE. 3.95  
 VACUUM CONDRSR 100MMF/7500V GE. 4.95  
 VACUUM CONDRSR 50MMF/20000V JEN. 6.95  
 RAYTHEON VOLTAGE REGULATOR adj V  
 inpt taps 95to130V/60cy; outpt 115V/58  
 AMPS one half 1% REGULATION; wt. 20  
 lbs 6 1/4 H 8 1/4 L 4-3/4" W. Rugged dsgn. SPE-  
 CIAL. 10.95  
 HVI-DUTY VOLTAGE REGULATOR INPUT  
 TAPPED 198to242 Volts 50/60cy; OUTPUT  
 220VOLTS/500WATTS: One Half 1% Regu-  
 lation—RAYTHEON new S.C. D'sgn rugged  
 Construction wt 70 lbs, size 18-3/4 L 8W  
 9 1/2" H Relay Rack mtgng SPECIAL. 39.95  
 TRANSTAT 88-132V/18.2AMPS VARIABLE 29.95  
 WRITE TAB FOR S.C. TECH. MANUALS

WSTGHSE "DB" MTR 3 1/2" SQ B'C —10+6DB \$4.95  
 WSTGHSE 3 1/2" SQ BKL CASE 0-1ma RX35. 4.50  
 DEJUR 2 1/2" B'CASE 0-1ma STD SCALE. 2.95  
 GE RF MTR 2 1/2" B'CASE either I or 5AMP. 3.95  
 WESTON 476 AC 15VOLT MTR 3 1/2" SQ B'Case. 4.95  
 WESTON 506 MTR —10plus6DB 2 1/2" B'Case. 4.50  
 GE DW54 MTR —10plus6DB 2 1/2" B'Case. 3.95  
 GE DO40 3 1/2" B'C 2.5&25ma 0 ctr Galvo. 3.95  
 GE DW41 MTR 2000V/1000ohmperV 2 1/2" B'C. 5.95  
 GE AO22 MTR 0-150VAC 3 1/2" B'C. 4.95  
 McCLINTOCK 3 1/2" B'C 0-1ma Meter. 3.95  
 WSTGHSE DUAL 200microma no 0 adj. 1.95  
 WESTON 506 MTR 250ma 2 1/2" B'C. 3.25  
 WSTGHSE 2 1/2" B'C 30VOLTS AIRCRAFT. 2.75  
 SPEECH AMPLIFIER ART13 COLLINS. Line  
 carbon or Dyn Mike; Output to PP class B  
 Grids. Chassis includes inpt transf & 1st  
 Audio. 6V6 sidetone adj AudioOsc AMP &  
 Hdphone jack Wt 51 lbs. 7-1/2 L 3 1/2 W 5" H less  
 tubes & pwr supply includes instructions.  
 SPECIAL. 4.95  
 WITH TWO 6V6 & 6SJ7. 7.49  
 GE Voltage Control Relay P3V/115V/60cy SP  
 self reset Calib 70/85/110/160V NEW. 5.95

## NEW GUARANTEED

MODEL 5053

Mfg'd A. G. Redmond

W. E. Stern  
 Electric KS-5868-L03  
 Input Output Duty  
 28VDC 250V Continuous  
 1.4Amp 60ma  
 Wgt—2 lbs.  
 Qty 1800

"TAB" SPECIAL PRICE  
 \$1.85

Works as 110VDC Motor  
 Can be used on 12VDC input by  
 paralleling field coils.  
 Air Corps Dy.-2B/ARR-2

★ ★ ★ ★ ★

## GENERATOR

MODEL G101

Mfg'd Fractional Motors

Input Output  
 3/16 HP Motor 430VDC  
 RPM 180ma  
 3450 Duty-Continuous  
 Dim. 8" L 5" Dia./SHAFT 2 3/4" x 1/2" D  
 Wgt—17 lbs.  
 QTY 200

"TAB" SPECIAL PRICE  
 \$8.95

Can be used as DC 110V Motor

# DYNAMOTORS

ALL BRAND NEW

"Tab" Specially Priced at a Fraction  
 of Their Original Cost

WRITE FOR QUANTITY PRICES

Can be used as motor or dynamotor



Illustrated Unit

S. C. DM-4 Model D104

Mfg'd Fractional Motors

INPUT RPM Duty Output DC  
 12 or 24 V DC 4000 Continuous 225Volts/100ma  
 440Volts/200ma

Wgt. 21 lbs. Dim. 11" L 5" Dia. Qty., 1500  
 "TAB" SPECIAL PRICE  
 \$6.75

## S. C. NAVY AIR CORP SPECIF

MODEL DA-3A

Mfg'd Bendix & Webster

INPUT RPM Duty  
 28VDC 4700 Continuous  
 10.5Amp  
 Output #1 Output #2 Output #3  
 300VDC 150VDC 14.5V  
 260ma 10ma 5Amp

Wgt—21 lbs. Dim. 12 1/2" L 5"  
 Dia., Qty. 1500

"TAB" SPECIAL PRICE  
 \$3.85

★ ★ ★ ★ ★

MODEL PE-94A

Mfg'd Bendix MG-1A

Aircraft Completely Cased  
 Input & Output Filters, Voltage  
 Regulators & Relays

Input RPM Duty  
 24-28VDC 6000 Continuous  
 13Amps  
 Output #1 Output #2 Output #3  
 300VDC 150VDC 14.5A  
 260ma 10ma 5Amp.

Wgt—34 lbs.  
 Qty. 100

"TAB" SPECIAL PRICE  
 \$9.95

CHOKE GE 12Hy/300ma cased \$2.95  
 KENYON CHOKE 20Hy/300ma or 15Hy/400ma  
 Cased 15000V insulation wt 40 lbs. 7.95  
 CHOKE 20Hy/100ma cased SPECIAL. .98  
 STROBO FLASH Transf 1540V/115V/60cy. 4.95  
 HICKOCK 4" SQ Tube Tester Meter. 6.95  
 PRECISION 1% Wirewrd Onemeg resistors 90c  
 @ 3 for. 2.00  
 1.8meg., 2.0, 4.5, 5.0, 10Meg/1% H.V. SIX for. 3.00  
 WE DYNAMIC MIKE 20ft CABLE. 7.95  
 8mf/660VAC/2000WVDC @ \$3 FOUR for. 8.95  
 2mf/3000WVDC \$4; 4mf/3000WVDC. 5.00  
 2mf/5000WVDC \$10; 1mf/5000WVDC. 15.00  
 1mf/10000WVDC \$20; 1mf/25000WVDC. 75.00  
 RCA 808: 446/2C40/21or\$5; 304TL 2 for. 2.19  
 450TL/329; 807/95c; 813/86.95; 815. 2.19  
 845/83.75; 829B/3E29/\$2.90; 954/50c@ 5 for. 2.00  
 5BP1,5CP1,5BP4/\$3.55@; 3BP1 & SOCKET. 2.99  
 955,56,57,58A,59 & Socket/90c@; 2C26. .75  
 1625/65c; 2V3G/75c; 872A & SOCKET 2 for. 5.40

SEND ORDERS FOR ALL TUBE  
 REQUIREMENTS

Tubes guaranteed exception breakage & Open Fil.  
 WRITE FOR TUBE, PRECISION RESISTORS &  
 CONDENSER LIST

FREQ METER MANUAL SCR211 S.C. 1.00

UTC 8Hy/150ma NEW cracked Bake T' Bd. \$0.89  
 866A Combination transformer, 2sockets&tubes  
 TRANSFORMER ONLY FOR TWO 866A. 5.95  
 TUBES 3.95  
 872A Combination Transformer, 2sockets&tubes 12.00  
 CRYSTAL DIODE TEST SET 268U NEW. 6.95  
 CRYSTAL DIODE IN34 @ \$1.39 TWO for. 2.40  
 CRYSTAL DIODE IN21 @ 45c THREE for. 1.50  
 CRYSTAL DIODE IN26 @ \$1 TWO for. 5.95  
 CRYSTAL STD 200KC/0.1%accy Vacuum. 1.00  
 CRYSTAL STD 7010KC/0.1%accy TWO for. 2.95  
 Vacuum Xtals GE 93.12 or 81.95KC ea. 7.95  
 HANDIE-TALKIE BC611 Chassis. Coils, X. 19.95  
 TRANSF 115 or 230V/50-60cy/1400Watts Csd. 2.95  
 Auto transf 115/160/170/180V/60cy Cased. 2.95  
 IF STRIP 30mcs/85DBgain 8/6AK5 & 1/6AL5  
 2x11x2 3/4"H/12mcs bnd width, outpt Jack &  
 COAXIAL inpt plug ideal IF STRIP TELE-  
 VISION. 9.49  
 TRANS Modulation PP parallel 6L6's or 807's  
 to PP RF 807's/2000ohm load. 2.95  
 Choke Swinging 15-29Hys/150ma. 2.95  
 Trans 115V/60cy 7.5V/12Amp H.V.  
 Choke Swinging 15-29Hys/150ma. 2.95

\$2 Min. order FOB N.Y.C. Add Postage all orders  
 and 25% deposit. Worth 2-7230. Send for catalog 99.  
 Specialists in International Export, School, College  
 & Industrial trade. Money-back "TAB" Guarantee.

KIT SPAGHETTI SLEEVING ASSTD 75ft. \$1.00  
 KIT HARDWARE GOOD ASSMNT ONE LB .99  
 KIT GROMMETS RUBBER 100 ASSTD. .99  
 KIT MOTOR BRUSHES 100 ASSTD. 1.00  
 KIT FUSES ASSTD BUSS & L.F. 300 for. 1.95  
 KIT KNOBS ASSTD WITH BUSHINGS 25 for. 1.25  
 KIT ROTARY SWITCHES SIX for. 1.75  
 KIT POWER RHEOSTATS 25 & 50 WATT  
 6 for. 4.95  
 KIT WW RESISTORS 20 for. 1.00  
 KIT RESISTORS 1/2 & 1W/50to2megs 100 for. 2.50  
 KIT CONTROLS 50—2Megs POTS AB/J  
 10 for. 2.50  
 KIT SILVER & MICA CONDENSERS 50 for. 2.00  
 KIT LUGS GOOD ASSMNT 100 for. 1.00  
 KIT ELASTIC STOP NUTS ASSTD 75 for. 1.00  
 KIT SOCKETS OCTAL, LOCTAL etc 50 for. 2.95  
 KIT G&P Tube Grips ASSTD 50 for. 1.00  
 KIT RADID SOLDER 2 lbs. .98  
 AUTOSYNS TYPES/15V/60c NEW 2 for. 18.00  
 AUTOSYNS Type5/SynchroDifferential. 6.95  
 AUTOSYNS BENDIX TYPE 2/15V/60cy 2 for. 18.00  
 AUTOSYNS TYPE5/50V for 115V/60 c 2 for. 8.95  
 AUTOSYNS 50V Synchro Differential. 3.95  
 FOR AUTOSYNS—SELSYNS—MAGNESYNS  
 C "TAB"

"TAB" Dept. 9RN, Six Church Street, New York 6, N. Y., U.S.A. "TAB"

THAT'S A BUY CORNER CHURCH & LIBERTY STS., ROOM 200 THAT'S A BUY

# BRAND NEW-BC-612 OSCILLOSCOPE \$49.95

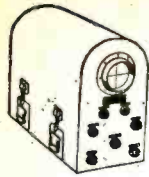

BC-612 Oscilloscope. Brand new factory cartoned. weight 200 lbs. This unit is the most ideal war surplus scope. Works on 110v 60 cycle AC. Only simple changes (conversion in many radio magazines) necessary to convert to a laboratory test scope. Has twin heavy duty plate supplies and tubes 5BF4 5" scope tube, 6-6L6, 2X2, 5T4, 2-6SJ7, 6SC7, 6H6, etc. Schematic diagram with each unit. This may be the last time we have a scoop in a scope like this. Net. \$49.95

## NAVY ARB RECEIVER, \$19.95

You can convert this over, easily to a good ham receiver. It's one of the hottest values in surplus receivers. 28 volts DC input. Covers 4 bands. 195 kc to 9 mc. This is a deluxe type superhet receiver, note that the frequency coverage includes the standard broadcast band. Has 4 gang tuning condenser; can be converted to a 110 volt AC receiver. Priced complete with tubes: 12SF7, 12SA7, 3-12SF7 and 12A6. Has dial built on front of chassis. Electric driven or manual band change switch. Weight 28 lbs. Size 6x7x15 inches.

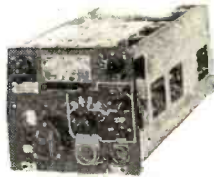

ARB Near new condition, with tubes and dynamotor.....Net \$19.95  
ARB Brand new, factory cartoned, with schematic.....Net 39.95  
New remote control for ARB. \$12.00 extra.

## GLIDE PATH RECEIVER, \$9.95



R-89/ARN-5 Glide Path Receiver 11 tube superhet. Formerly used for blind landing. Adaptable for many uses. Receives 326 to 335 MC. Contains six relays. 11 tubes 7-6AJ5, 12SR7, 2-12SN7, 25D7. Size 13x5x6. Weight 12 lbs. A beautiful piece of equipment. Has three crystals. Priced complete with xtals and tubes.

R-89/ARN-5 Near new condition .....Net \$ 9.95  
R-89/ARN-5 Brand new, factory cartoned .....Net 14.95

### VEEDER-ROOT METER AND CASE

Counts number of feet of trailing wire antennae; number turns when winding on coil; applicable for many uses; beautiful bakelite case, jeweled dialite, pilot light, enclosed, 3 position switch, counts up to 1000.  
Each .....95c



### KEYS—49c

Brand new keys.  
Factory cartoned.  
While they last,  
\$0.49 each  
10 for \$3.95

## BC-654 TRANSMITTER RECEIVER \$12.95

GUARANTEED TO BE IN GOOD CONDITION

7-Tube Superhet Receiver and 6-Tube Trans. with 25 Watts Power.



Order Now at this Scoop Price. Covers 3800 Kc. to 5800 Kc.

Portable voice and CW transmitter and receiver for portable, mobile, and fixed station operation. 7-tube superheterodyne receiver with 3.5 microvolt sensitivity on voice and 0.5 microvolt sensitivity on CW, and 100 milliwatts undistorted power output. 455 KC IF. Uses 3-1N5GT, 1-1A7GT, 2-3Q5GT, 1-1H5GT tubes. 6-tube transmitter, with antenna tuning network, Colpitts thermal compensated oscillator, class C final with 2-307A tubes in parallel, CW and 11.2 watts output on voice. Frequency range, transmitter and receiver. 3800 to 5800 KC. Ideal for Hams! Comes complete with cover; furnished with all tubes necessary for the operation of the trans. and rec. lights. Less power supplies. These units are used but in good condition. Shipping weight 50 lbs. \$12.95; 2 for \$25.00  
Send your order to our Kansas City store. This unit will be shipped from our Chicago warehouse. Immediate delivery. You can hardly tell they are used.  
BC-654 Less all tubes and crystal.....\$7.95

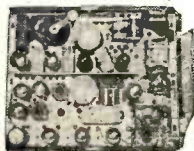

## BC-645, \$14.95 Each Two for \$29.00

Made by General Electric. Factory printed Conversion Diagram. New, factory cartoned.  
15 tubes. Covers 450 mc.

ARMY BC-645 I.F.F. UNIT. Early in the war when radar picked up a plane, there was no way of knowing whether it was friendly or not. That was before BC-645 was invented. BC-645 sent out a signal that identified the plane as American. It probably saved more lives than any other piece of electronic equipment made. With some modifications the set can be used for 2-way communication, voice or code, on the following bands: ham hand 420-450 mc., citizens radio 460-470 mc., fixed and mobile 450-460 mc., television experimental 470-500 mc. Equipment capable of doing the jobs of the modified set sells for hundreds and hundreds of dollars. The 15 tubes alone are worth more than the sale price. 4-7F7, 4-7H7, 2-7E6, 2-6F6, 2-955 and 1-WE316A. It now covers 460 to 490 mc. Each BC-645 is shipped with a Belmont factory printed conversion diagram, showing how to make AC power supply, modulator and how to make Transmitter and Receiver changes. Most Hams and experimenters already have the few parts necessary. New BC-645 with tubes less power supply. Shipping weight 25 lbs. Extra WE316A Tubes \$1.29 each. 12 Volt Dynamotor .....\$4.95



## SWITCH-POT. SALVAGE, 99c

A real salvage scoop. Has 3 toggle switches, 1 band switch, 6 standard size carbon controls, knobs, etc. Scoop price .99. 3 for.....\$2.50

BC-1366 Jack Box 11 bank banana plug jack and socket with 5 position single deck switch and control. 2 phone jacks. Scoop price .59 2 for \$1.00



## SCOOP, \$1.99



Heavy Duty Vibrator—Made for 6-110 volt amplifiers. Freq. 60 CPS. Scoop price. \$2.99  
1135 ma 6-110 volt conventional power transformer, with all windings; will run phone motor.....\$5.95  
(Use with above vibrator.)



## LS-7, \$2.95

Army LS-7 speaker—Heavy Duty Alnico 5 PM. Works on BC-654-a and other receiver. Net. \$2.95



## BOX SCOOP 79c

ARMY SPARE PARTS BOX. Handy for tools or fishing tackle, etc. Has water tight hinged lid. Made of 3/4" water proofed plywood. Size 3 x 11 x 5 1/2. Scoop Price .....79c

## NEW BC-1206 \$7.95

Setchell Carlson Radio Receiver BC-1206C



Designed to receive A-N beam signals. 24-28 vdc. Tube complement: 14H7, 14A7, RF amplifier 14H7, 14I7 mixer, 14A7, 14H7, IF amplifier; 14R7, detector and 1st audio amplifier; 28D7, output amplifier. 195 to 420 KC 4" high x 4" wide x 6 1/2" long. Weight 4 lbs.  
Brand New in Original Cartons. \$7.95

Small Universal output transformer .....\$0.89  
Medium Universal output transformer 6 watt......99  
40 mill 6.3, 5 and h.v. power ..... 1.99  
55 mill 6.3, 5 and h.v. up-rite ..... 2.49  
pwr. trans. .... .99  
2 gang .000365 condenser..... .99  
Same with cut section 456..... .99  
Small loop antenna..... .39  
Oscillator coils ..... .19

## AM-26 \$1.49

INTERPHONE SALVAGE SCOOP



AM 26 interphone amplifier. This unit is nice for parts salvage and the aluminum case is usable for receiver building etc. Size 9 1/2 x 4 1/2 x 5". Has two transformers, four tubes sockets, three filter condensers, three position panel switch, toggle switch, and many small parts. All are in perfect condition.  
\$1.49; 2 for \$2.49

4000 ohm head-phones. Civilian type, with standard 5-foot cord. Finest type made by Trimm. Scoop Price..\$1.69

## R65 SCOPE, \$29.95

Another receiver indicator unit; with gobs of material. Complete with 28 tubes such as: 6SA7, 6SK7, 6H6, 2X2, 5Y3, etc., plus 3BP1 scope tube. A multitude of controls, RF coils, switches, etc. All are in perfect condition; just removed from aircraft. Case size, 9x12x16". Ideal to convert to test scope and beautiful for general salvage. Weight 35 lbs.  
Scoop Price .....\$29.95

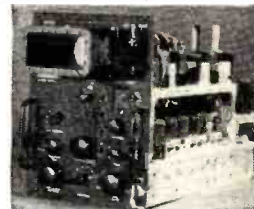

## BC929 RADAR, \$14.95

BC-929 A Radar Indicator Scoop. This unit could be rebuilt into a fine test scope. It is an ideal size. 8x9x14 priced with tubes 2-6SN7, 2-6H6, 6G5, 6X5 and 2X2. This is a red hot buy. However you will have to change the power trans. for 60 cycle use. Guaranteed to be in good condition.



Scoop Price .....\$14.95  
Weight 20 lbs, Has 3 in. Cr Tube.



## NAVY SALVAGE SCOOP! \$3.95

Navy model ZA Glide path receiver. Has 3-6C6 tubes; several controls, transformer and handy case; size 6x7x12 inches. Ideal for salvage, near new condition \$3.95. 2 for.....\$6.95

## SCR-522 TRANS. REC., \$19.95



SCR-522 You are all familiar with this 100 to 156 MC Transmitter, receiver. These 522's that we have are in rough looking cases and some of the outside connectors have been damaged. However, we guarantee that if you separate the transmitter and receiver and remove the case, you will have usable merchandise. There are not many more of these units available; we have just 100 to sell.

## PACKARD BELL PRE-AMP., \$1.99

Housed in a handy aluminum case 5x4x5, priced complete with tubes 6SL7, 28D7, has many usable parts. Relay and control PL68 plug and patch cord.



# McGEE RADIO COMPANY

WRITE FOR CATALOG SEND 20% DEPOSIT—BALANCE C.O.D.  
1225 McGEE ST., KANSAS CITY, MISSOURI

**PERSONAL PORTABLE KIT, \$10.95**

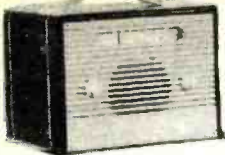

**PERSONAL PORTABLE KIT MODEL K-PX.** 8 m a 1 l size leatherette covered case 8x6x7. Easy to build. Operates on self contained B and A batteries. I t e c . Broadcast 550 to 1600 K. C. Incorporates a standard superhet circuit with AVC. Has 3 inch Alnico five PM speaker. Priced complete with batteries, pictorial diagram and tubes IR5, 1S5, 1T4 and 3S4. Not AC DC, but straight battery operated. Has 2 gang cond. Everyone should have one of these personal portables. Everything furnished. Kit K-PX.....Net \$10.95

**3-WAY PORTABLE KIT, \$17.95**

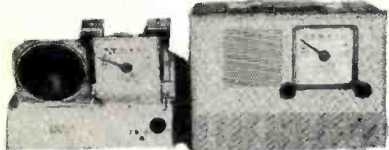

Build this powerful, 4-tube, 3-way portable kit. Operates on 110 volts AC or DC or self contained batteries. Receives broadcast 550 to 1650 K.C. Incorporates a standard superhet circuit with AVC and loop Ant. Has Alnico 5 PM Speaker, 2 gang condenser. All Parts and batteries are furnished including tubes Disc Rectifier, IR5, 1T4, 1S5 and 3S4. Has attractive leatherette portable cabinet size 7x9x9. Weight 14 lbs. Kit model 3-ZA.....Net \$17.95

**BEAUTIFUL PLASTIC KIT \$9.95**

Kit Model P-85. We have finally been able to achieve our goal. Here it is. A good 5-tube broadcast AC DC superhet radio receiver for less than ten dollars. The beautiful 10 inch plastic cabinet is made of the finest material. The chassis is of the standard accepted superhet design. 456 KC IFS AVC and 5 inch Alnico 5 PM speaker. Attractive vernier dial. Two gang tuning condenser. Loop Ant. We defy anyone to offer a better working AC DC receiver kit. Priced complete with diagram, photos and tubes 12BE6, 12BA6, 12AT6, 50B5 and 35W4. Nothing else to buy. You can't go wrong on this value. Kit Model P-85.....Net \$9.95



**NEW SUPER MIDGET KIT, \$12.95 MODEL KP-T**

Build this new super Midget Broadcast Radio. Has beautifully made, highly polished walnut cabinet. Size 7 1/2 x 4 1/2 x 5 1/2. Attractive slide rule dial. Incorporates a standard superhet circuit with 456 KC IFS & AVC. Has 2 gang condenser and loop ant. Every part including Alnico V. P.M. speaker and tubes. 12BE6, 12BA6, 12AT6, 50B5 & 35W4. Furnished as well as photo and easy to follow diagram. Weight 5 lbs. Net \$12.95



**KIT K-7A.** Easily assembled into a fine working, attractive, transformer type AC, broadcast receiver; 550 to 1700 KC. Has push-pull audio, tone control and 6 1/2" Alnico 5 PM speaker. Beautifully made 14" walnut cabinet. Incorporates a standard superhet circuit, with AVC and loop antenna. All parts, schematic and tubes 6SA7, 6SK7, 6H6, 6SN7, 2-6V8's and 5Y3 furnished. Has full 00 mil. power trans. Weight 17 lbs. Dealers Net \$19.95



**Deluxe AC Kit, \$14.95. Model JD5 AC.** Has beautifully made 12" walnut cabinet. All parts furnished to build a powerful broadcast 5 tube AC, power transformer type, superhet. Rec. 440 to 1700 KC. Slide rule dial, 2 gang tuning cond. Loop aerial. Heavy duty Alnico V. PM speaker. Everything furnished including photos, diagram and tubes. 6SA7, 6SD7, 6SQ7, 6K6 and rectifier. Kit JD5 AC. Net.....\$14.95



**20-WATT UTILITY AMP. KIT, \$17.95**

Build this 20 watt utility 110 volt AC, 20 Watt power amplifier. Ready punched aluminum chassis, size 12 x 6 x 2 1/2 inches. Has two input circuits, one mike and one phono. Mike stage has 135 DB gain for crystal or dynamic mike. Has bass and treble controls. Designed for use with PM speakers; has 8-16 ohm output transformer. All parts, controls, transformers and easy-to-follow diagram furnished, including tubes: 2-6SN7, 6J5, 2-6L6GA, 5Z3. Kit Model 20-LX. Net.....\$17.95 12" 12 watt Alnico 5 PM speaker, \$6.95 extra. Astatic crystal mike and desk stand, \$7.95 extra.



**COMMAND RECEIVERS**

The Army Aircraft Receiver BC-454 covers 3 to 6 MC. Has 3 gang tuning condenser and two stages of 1415 KC. intermediate frequency. By removing plates from the gang and re-winding the Ant., R.F. and osc. coils you can have a real hot 10 meter receiver. We have plenty of these in the original factory carton. Priced less the 28 volt dynamotor. Has 3-12SK7, 12SR17, 12K5, and 12A6. Near new BC-454-B 3 to 6 MC receiver with all six tubes.....Net \$3.95

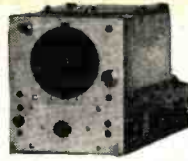

Near new BC-455-B 3 to 6 MC receiver with all six tubes.....Net \$3.95 Brand new factory cartoned BC-454-B 3 to 6 MC with all tubes.....\$5.95 Brand new factory cartoned BC-455-B 6 to 9 MC with all tubes.....\$5.95 Receiver dynamotors 28 volts.....Net \$0.95 **BC-946-B Broadcast receiver with diagram and tubes. Fact. cartoned.....\$12.95**



Triple remote control head for SCR-274 (BC-453-B, BC-454-B, BC-455-B).....\$1.95 Flexible cable for tuning SCR-274.....\$0.79 Mounting Rack for 12 tubes receivers.....\$1.95

**AIRCRAFT TRANSMITTERS**



**BOTTOM VIEW**

Western Electric and really rugged. The oscillator will hold the frequency, even under rough operating conditions. Has 12.5 M. O. and 2-1625 (807) in parallel as final P. A.; or buffer to feed into a high power rig. Built-in crystal dial calibration checker. Antenna loading inductance. Near new BC-457-A Transmitter 4 to 5.5 MC. Complete with 4000 KC crystal and tubes. Your Cost \$3.95 Near new BC-458-A Transmitter 5.3 to 7 MC. Complete with 6200 KC crystal and tubes. Your Cost \$5.95

This really fits the ham's dream. Ideal for a 55 watt transmitter with 575 volts at 250 MA plate supply, or VFO to drive a high power rig. It's a companion unit to the 454-455-453 series aircraft receivers. Made by Western Electric. Price \$3.95

**NEW TRANSMITTERS**

Scr-274 (AN/ARC-5) SCOOP! Brand new, factory cartoned transmitters BC-457-A 4 to 5.3 MC with tubes and crystal.....\$9.95 Brand new, factory cartoned transmitters BC-458-A 5.3 to 7 MC with tubes and crystal.....\$9.95 Brand new, factory cartoned trans. BC-459-A 7 to 9 MC with tubes and crystal.....\$9.95

**NEW NAVY 6-9 MC. REC., \$7.95**

Navy Aircraft Receiver R 27. 6 to 9 MC. Brand new, factory cartoned. Has black wrinkle finish. With tubes 2-12SK7, 12K5, 12SR17, 12SH7 and 12A6. This is the latest model with stabilized oscillator. Priced with tubes, 28 volt dynamotor, remote control, 6 ft control cable. Less the power cable.....\$7.95 Scoop Price.....\$7.95



**Left to Right** New Remote Control Head and volume control CW, MCW, sw. for BC-455-B 6 to 9 MC receiver. Scoop Price, \$0.99 BC-631-13 Jack Box. NEW. Has 10M gain control and Jones 6 screw terminal block. Salvage Price.....\$0.29 Salvage Scoop BC-732-A Radio Control Box. Toggle switch, volume control and 6 position single pole cam-operated switch; phone jack. Scoop Price.....\$0.49



**12 WATT Amplifier Kit, \$10.95.** For recording and utility use. Matched component parts assure low hum level and good bass. One control, fades from record to microphone; tone control. Priced complete with all parts and tubes: 2-6V6, 6SN7, 6SH7, 7Y4. Diagram and photos furnished. 12" Alnico V PM speaker \$6.95 extra. Crystal desk mike \$4.95 extra. Kit AC-12. Net.....\$10.95



**9-TUBE KIT, \$24.95**

AKH-11 Kit. A deluxe 9 tube, twin speaker, high fidelity receiver kit; housed in a beautiful hand rubbed walnut cabinet of latest design, with dual speaker grills in perforated gold tint plastic. Circuit employs push-pull parallel 12A6's delivering 10 watts of undistorted power to twin 6" G.E. Alnico V speakers. Other tubes: 12K8, 12SK7, 12H6, 12J5, 12SR17 and two dry disc rectifiers in voltage doubler circuit (equivalent to 11 tubes in all). Has 10" slide rule dial. Complete with instructions; ready to wire. Your Net.....\$24.95



**DELUXE CONSOLE CABINET, \$39.95**

- Slide Away Changer Comp.
- Record Album Compartment
- Beautiful, All Walnut Construction



This is the first time we have been able to offer a beautiful floor model console, RADIO-PHONO cabinet. Finest 1 1/2" walnut construction; hand rubbed finish. 34" long, 33" high, 16" deep. Holds 12" speaker, large record compartment. Slide away changer compartment will accommodate changer of the Webster 56 class and smaller. Receiver compartment is 15x14 1/2 x 7 1/2 inches. Will accommodate our Model PRK-10 kit; advertised below. Dealers, here is your chance to buy good cabinets at the right price. Convert those low-priced sets into radio-phonos combinations. Weight 50 lbs. Net, \$39.95. Price with Webster 56 changer.....\$59.90

**8-TUBE RADIO AMP. KIT \$29.95**

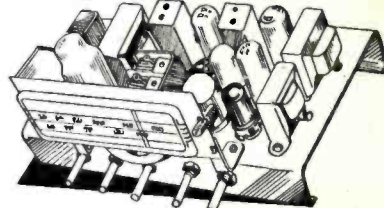

**Build this High-F. Radio Amplifier**

- Beautiful 8" Slide Rule Dial.
- Standard Superhet Circuit covering Broadcast 550 to 1700 K.C.
- 2-Gang Tuning Condenser.
- Offered with 12 or 15 In. PM Speakers. Push-pull 6V6 Output stage giving 15 watts of full range audio.
- Dual Tone Controls (Bass and Treble).
- Inputs for both Mike and Phono pick-up.

Here is something new in radio. A real 15 watt power amplifier with bass and treble controls. Has extra gain stage for crystal or dynamic mikes. And on the same chassis, a standard superhet radio receiver. We furnish all parts, knobs, escutcheon plate and tubes: 6SA7, 6SK7, 6SR7, 6SN7, 6SJ7, two 6V6 and 5Y3. No cabinet. Extra care in designing the power supply section assures low hum level, making this unit ideal for recording as well as P.A. use. We furnish everything as well as schematic diagram and photos of the completed chassis. Weight 35 lbs. PRK-10 Radio Amp. Kit with 12 P.M. Speaker.....Net \$29.95 PRK-10X Radio Amp. Kit with 15 In. \$30.00 value Cinnadograph speaker.....Net \$42.95 **WHY NOT ORDER A G.I. RECORDER MECHANISM AND THE CABINET, SHOWN ABOVE, WITH THIS KIT? PRICES ON G.I. UNITS ELSEWHERE IN THIS AD.**

Walnut mantel type cabinet; made expressly to house the PRK-10 kit. Ready cut. Accommodates receiver chassis only, not speaker. Weight 8 lbs. Net, \$6.95

Army BC-221 Frequency Meter in good condition.....\$39.95

**RADIO-PHONO COMB. KIT, \$24.95**



Build this beautiful portable combination radio phonograph. We furnish everything. Beautiful two tone portable case, latest rim drive phono motor, Astatic crystal pick-up. All parts to build high quality 5 tube AC-DC radio. Tubes broadcast 550 to 1700 KC. has tone control, loop antenna, 6" Alnico 5 PM speaker. Tubes 12SA7, 12SK7, 12SQ7, 50L6 and 3Z5. Simple diagram furnished. Kit Model RP-12. Wt. 20 lbs. Your Cost \$24.95

**RECORD PLAYER SCOOP, \$14.95**

Assemble this single record player. Only a few minutes required to mount pick up, motor and ready wired and tested amplifier. Everything furnished including tubes 12SR7, 50L6 and 3Z5. Has heavy duty Alnico V PM speaker, tone and volume controls. Has latest crystal pick up and 78 RPM phono motor. The attractive Alligator covered case is smart and ruggedly constructed. (15x6 1/2 x 11.) This is our leader in a portable record player. Weight 18 lbs. Kit J-20. Net.....\$14.95



**WALNUT CABINET RECORD PLAYER \$16.95**

Beautifully made, highly polished walnut cabinet with hinged lid. Plays 10" records with 11 d closed. Latest rim drive phono motor and high output. Astatic crystal pick-up. High power 3 tube AC-DC phono amplifier (wired and tested). Heavy duty 4" Alnico 5 PM Speaker. Single record player kit. Model WL-3. Wt. 15 lbs. Your Cost \$16.95



**McGEE RADIO COMPANY** WRITE FOR CATALOG SEND 20% DEPOSIT—BALANCE C.O.D. 1225 McGEE ST., KANSAS CITY, MISSOURI

# "SPECIALS"

## ANTENNA RELAY UNIT BC-442

With antenna current meter, antenna transfer relay with 3 stand-off lead-in terminals. A-1 condition. Only **95c**

### TRANSFORMER

High voltage scope transformer, 90V 60 cps. primary; 6400 V secondary; 4 stand-off terminals.....each **\$2.95**

### ANTENNA TRANSFER SWITCH SW-225

Triple-pole, double-throw, mounted on bakelite base with nine 2" porcelain stand-off mounts. BRAND NEW..... **89c**

### BC 732 CONTROL BOX

With 6 position, selective switch, volume control and toggle switch.....each **79c**

### COAXIAL CABLE

26 ft. of Coaxial Cable RG8, 52 ohm..... **89c**

### OUTPUT TRANSFORMERS

50L6.....39c 6V6.....39c

### FILTER CHOKES

#### All Fully Enclosed

Dual, 15H. @ 100 MA., 400 ohms DC. Each section, 500 VDC insulation test. 3 1/2"x3"x6" High; 4 MTG. Studs and 4 terminals. Each **79c**

59H. Min. @ 100 MA.; 10 V RMS 60 cycles, 850 ohms DC. Res.; 4 MTG. Studs, size 4 1/2"x3 1/2"x3 1/2", each..... **79c**

3.7 H. @ 145 MA. DC., 125 ohms DC. Res. 4 MTG. Studs, each..... **59c**

### I-70-D TUNING METER

Milliammeter for indicating resonance of tuned station, NEW..... **49c ea.**

### INSULATOR

2 Ceramic bowls, 3 1/2" dia..... **29c ea.**

### 400 CYCLE AUTOSYN MOTOR

Ideal for indicating direction of antenna systems—BRAND NEW..... **95c ea.**

### FLEXIBLE CABLE

From 92' to 250' with connectors and spline knobs..... **\$1.95**

### HEADPHONES

Signal Corps, 8000 ohms and 200 ohms, each..... **\$2.49**

2000 ohms, Trimm, each..... **1.79**

EARPHONES, less headband, HS18 high impedance..... **79c**

### INTERPHONE AMPLIFIER

Comes in an aluminum cabinet 9 1/2"x4 1/2"x5 1/2" with two 12J5GT and two 12A6 tubes; also Electric Dynamotor 28DC Volt input and 250 V DC output at 60 MA.

Complete with 4 tubes. Yours for only **\$4.95**

### LP-21 ADF LOOP

Low impedance loop, good for direction finder, one Selsyn motor, one Selsyn transmitter, frequency of loop 100 Kc to 1750 Kc: BRAND NEW in original cartons, each..... **6.95**

### PE-117 UNIVERSAL POWER SUPPLY

6 or 12 volt input; output 145 volts and 90 volts; less vibrator, voltage regulator and rectifier tube; ideal mobile power supply unit; excellent condition, each..... **4.95**

Wholesalers, dealers, institutions and other quantity purchasers, write, wire, phone for quantity prices. All shipments F.O.B. Chicago. 20% deposit required on all orders. Minimum order accepted \$5.00.

#### WRITE FOR CATALOG

Dept. C

## ARROW SALES, INC.

59 WEST HUBBARD STREET  
CHICAGO 10, ILLINOIS  
Telephone: SUPERIOR 5575

# Parts Lists

(FOR CIRCUIT DIAGRAMS APPEARING ON PAGES 76 AND 77)

### ADMIRAL MODELS 7T06, 7T12

Part No.	Code and Description.
60B8-153	R <sub>1</sub> —15,000 ohm, 1/2 w. res.
60B2-474	R <sub>2</sub> —470,000 ohm, 1/4 w. res.
60B8-224	R <sub>3</sub> —220,000 ohm, 1/2 w. res.
60B8-333	R <sub>4</sub> —33,000 ohm, 1/2 w. res.
60B2-475	R <sub>5</sub> , R <sub>6</sub> —4.7 megohm, 1/4 w. res.
60B2-225	R <sub>7</sub> —2.2 megohm, 1/4 w. res.
75B1-1	R <sub>8</sub> —1 megohm vol. control
60B2-105	R <sub>9</sub> , R <sub>10</sub> —1 megohm, 1/4 w. res.
60B2-391	R <sub>11</sub> —390 ohm, 1/4 w. res.
61A2-1	R <sub>12</sub> —75 ohm, 1/2 w. res. (wire)
60B2-222	R <sub>13</sub> —2200 ohm, 1/4 w. res.
64B1-25	C <sub>1</sub> , C <sub>2</sub> , C <sub>13</sub> , C <sub>14</sub> , C <sub>16</sub> , C <sub>17</sub> —.01 μfd., 400 v. cond.
65B5-31	C <sub>3</sub> , C <sub>4</sub> —.0008 μfd. mica cond.
66A9-1	C <sub>5</sub> —Ant. & osc. trimmer
65B7-17	C <sub>6</sub> —.0001 μfd. mica cond.
64B1-14	C <sub>7</sub> —.002 μfd., 600 v. cond.
67A4-2	C <sub>8</sub> —4 μfd., 150 v. elec. cond.
64B1-32	C <sub>9</sub> —.05 μfd., 200 v. cond.
65B7-22	C <sub>10</sub> , C <sub>11</sub> —.00025 μfd. mica cond.
64B1-12	C <sub>12</sub> —.005 μfd., 600 v. cond.
AC105-1	L <sub>1</sub> —Antenna coil
A1020	L <sub>2</sub> —Osc. coil
72B5	L <sub>3</sub> —First i.f. trans.
72B6	L <sub>4</sub> —Second i.f. trans.
AB103-1	L <sub>5</sub> —R.f. choke coil
98A5	T <sub>1</sub> —Output trans.

### EMERSON MODELS 507, 509, 518, 522, 535 CHASSIS MODEL 120005

Part No.	Code and Description.
397000	R <sub>1</sub> , R <sub>2</sub> —15 megohm, 1/4 w. res.
321330	R <sub>3</sub> —3.3 megohm, 1/4 w. res.
390000	R <sub>4</sub> —.5 megohm vol. control
321130	R <sub>5</sub> , R <sub>6</sub> —470,000 ohm, 1/4 w. res.
340290	R <sub>7</sub> —150 ohm, 1/2 w. res.
370490	R <sub>8</sub> —1000 ohm, 1 w. res.
310810	R <sub>9</sub> —22,000 ohm, 1/4 w. res.
340010	R <sub>10</sub> —10 ohm, 1/2 w. res.
397040	R <sub>11</sub> —15 ohm, 1 w. wirewound res.
321050	R <sub>12</sub> —220,000 ohm, 1/4 w. res.
900160	C <sub>1</sub> , C <sub>2</sub> —2-gang var. cond.
	C <sub>3</sub> , C <sub>4</sub> —Trimmers (Part of var. cond.)
	C <sub>5</sub> , C <sub>6</sub> , C <sub>7</sub> , C <sub>8</sub> —Trimmers (Part of i.f. trans.)
920010	C <sub>9</sub> , C <sub>10</sub> —.002 μfd., 600 v. cond.
920249	C <sub>11</sub> —.0005 μfd., 600 v. cond.
920020	C <sub>12</sub> , C <sub>13</sub> —.02 μfd., 400 v. cond.
910000	C <sub>14</sub> —.00022 μfd. mica cond.
920040	C <sub>15</sub> —.1 μfd., 200 v. cond.
920030	C <sub>16</sub> —.05 μfd., 400 v. cond.
925000	C <sub>17</sub> , C <sub>18</sub> —30/50 μfd., 150/150 v. elec. cond.
920050	C <sub>19</sub> —.2 μfd., 200 v. cond.
700000 or 700200	L <sub>1</sub> —Loop ant.
720000	T <sub>1</sub> —First i.f. trans.
720100	T <sub>2</sub> —Second i.f. trans.
734000	T <sub>3</sub> —Output trans.
716010	T <sub>4</sub> —Osc. coil
	SW <sub>1</sub> —Line sw. on vol. control

### CROSLY MODEL 56FC

Part No.	Code and Description.
AC-134898	1A, 1B, 1C—3-section var. cond.
39004-1	2—10 μfd., 500 v. mica cond.
B-132386-12	3A, 3B, 3C, 3D—4-section trimmer cond.
39001-80	4, 5—.02 μfd., 600 v. cond.
39001-17	6—.05 μfd., 600 v. cond.
39001-76	7, 14, 16—.003 μfd., 600 v. cond.
39001-1	8—100 μfd., 600 v. cond.
GC-210685-99	9—600 μfd., 300 v. mica cond.
W-49652-15	10—Trimmer cond.
GC-210685-138	11—480 μfd., 500 v. mica cond.
W-135130	12—Padder cond.
B-226638-54	13—75 μfd., 500 v. mica cond.
W-49664	15A, 15B—15/15 μfd., 140/140 v. elec. cond.
39001-78	17—.006 μfd., 600 v. cond.
39001-74	18—.002 μfd., 600 v. cond.
39294-25	19—100,000 ohm, 1/2 w. res.
39294-23	20—47,000 ohm, 1/2 w. res.
39294-35	21, 32—4.7 megohm, 1/2 w. res.
39294-37	22—10 megohm, 1/2 w. res.
39294-26	23—150,000 ohm, 1/2 w. res.
39294-31	24—1 megohm, 1/2 w. res.
39294-33	25—2.2 megohm, 1/2 w. res.
39294-34	26—3.3 megohm, 1/2 w. res.
39294-27	27—220,000 ohm, 1/2 w. res.
39294-6	28—68 ohm, 1/2 w. res.
39294-17	29—4700 ohm, 1/2 w. res.
B-130520-3	30A, 30B, 30C—1 megohm vol. control & sw. assembly
39294-16	31—3300 ohm, 1/2 w. res.
B-135198	32—100,000 ohm tone control
39014-25	33—1000 ohm, 1/2 w. res.
AW-135133	35—R.f. coil assembly
AW-135147	36—H.f. ant. coil assembly

Part No.	Code and Description.
AW-135134	37—B.c. coil assembly
AW-135140	38—H.f. osc. coil assembly
AW-135141	39—B.c. osc. coil assembly
AW-132803	40—First i.f. trans.
AW-132804	41—Second i.f. trans.

### ARVIN MODELS 555, 555A, 552N, 552AN

Part No.	Code and Description.
C20060-103	R <sub>1</sub> —10,000 ohm, 1/4 w. res.
C20060-106	R <sub>2</sub> —10 megohm, 1/2 w. res.
C20060-223	R <sub>3</sub> —22,000 ohm, 1/4 w. res.
C20060-331	R <sub>4</sub> —330 ohm, 1/4 w. res.
C20060-225	R <sub>5</sub> —2.2 megohm, 1/4 w. res.
C20060-156	R <sub>6</sub> —15 megohm, 1/4 w. res.
C19389	R <sub>7</sub> —Vol. control & sw.
C20060-220	R <sub>8</sub> —22 ohm, 1/4 w. res.
C20060-474	R <sub>9</sub> , R <sub>10</sub> —47 megohm, 1/4 w. res.
C20060-151	R <sub>11</sub> —150 ohm, 1/4 w. res.
C20060-334	R <sub>12</sub> —330,000 ohm, 1/4 w. res.
C20070-123	R <sub>13</sub> —12,000 ohm, 1 w. res.
E19359 or C19840	C <sub>1</sub> , C <sub>2</sub> —2-gang var. cond.
C20068-103	C <sub>3</sub> —.01 μfd., 400 v. cond.
C20065-500	C <sub>4</sub> —.00005 μfd., 500 v. cond.
A19765	C <sub>5</sub> —.2 μfd., 400 v. cond.
C20067-503	C <sub>6</sub> —.05 μfd., 200 v. cond.
C20068-503	C <sub>7</sub> —.05 μfd., 400 v. cond.
C20068-202	C <sub>8</sub> , C <sub>12</sub> —.002 μfd., 400 v. cond.
C20065-251	C <sub>9</sub> —.00025 μfd., 500 v. cond.
C20065-501	C <sub>10</sub> —.0005 μfd., 500 v. cond.
A19360	C <sub>11A</sub> , C <sub>11B</sub> —40/20 μfd., 150/150 v. elec. cond.
C20068-203	C <sub>13</sub> —.02 μfd., 400 v. cond.
AC19207-1	L <sub>1</sub> —Ant. loop assembly
AC19354-1	L <sub>2</sub> —Osc. coil
AC19357-1	L <sub>3</sub> —Iron core "B" choke
AC19355-1	T <sub>1</sub> —First i.f. coil
AC19356-1	T <sub>2</sub> —Second i.f. coil
AC19358-1	T <sub>3</sub> —Output trans.

### GAROD MODEL 5A1

Part No.	Code and Description.
1.443	1—Loop assembly
2.200	2—2-gang var. cond.
1.259	3—First i.f. trans.
1.259	4—Second i.f. trans.
8.200-9 or 8.200-4	5—Vol. control & sw.
30.303	6—4" PM speaker & output trans.
5.415-2	7—20/20/20 μfd. elec. cond.
1.444-1	8—Osc. coil

For other values see circuit diagram

### BELMONT MODEL 5P19

Part No.	Code and Description.
C-9B1-27	R <sub>1</sub> —220,000 ohm, 1/2 w. res.
C-9B1-67	R <sub>2</sub> —2700 ohm, 1/2 w. res.
C-9B1-84	R <sub>3</sub> —68,000 ohm, 1/2 w. res.
C-9B1-302	R <sub>4</sub> —15 megohm, 1/2 w. res.
C-9B1-62	R <sub>5</sub> —1000 ohm, 1/2 w. res.
C-9B1-34	R <sub>6</sub> , R <sub>10</sub> —3.3 megohm, 1/2 w. res.
101252	R <sub>7</sub> , R <sub>9</sub> —1 megohm vol. control & sw.
C-9B1-37	R <sub>8</sub> —10 megohm, 1/2 w. res.
C-9B1-31	R <sub>11</sub> —1 megohm, 1/2 w. res.
C-9B1-42	R <sub>12</sub> —22 ohm, 1/2 w. res.
130343	R <sub>13</sub> —545 ohm, 1/4 w. res.
C-9B1-66	R <sub>14</sub> —2200 ohm, 1/2 w. res.
130344	R <sub>15</sub> —1975 ohm, 6 w. res.
1009	C <sub>1</sub> —.05 μfd., 200 v. cond.
B-8A-10246	C <sub>2A</sub> , C <sub>2B</sub> , C <sub>3</sub> , C <sub>4</sub> —Two-gang cond. including ant. & osc. trimmers. Range of gang 14-452 μfd. (ant.) and 10-198 μfd. (osc.)
1295	C <sub>5</sub> , C <sub>15</sub> —100 μfd. mica cond.
100128	C <sub>6</sub> —.05 μfd., 120 v. cond.
100135	C <sub>7</sub> —.25 μfd., 120 v. cond.
100127	C <sub>8</sub> , C <sub>13</sub> —.01 μfd., 120 v. cond.
	C <sub>9</sub> —Part of i.f. (approx. 100 μfd.)
100134	C <sub>10</sub> —.006 μfd., 120 v. cond.
100133	C <sub>11</sub> —.1 μfd., 120 v. cond.
10025	C <sub>14</sub> —.002 μfd., 600 v. cond.
10013	C <sub>16</sub> —.05 μfd., 400 v. cond.
119123	C <sub>18A</sub> , C <sub>18B</sub> , C <sub>18C</sub> , C <sub>18D</sub> —20 μfd./40 μfd./200 μfd./40 μfd., 50/150/10/150 v. elec. cond.
B-13E-10250	T <sub>1</sub> —Loop antenna assembly
A-13D-10239	T <sub>2</sub> —Osc. coil
108201	T <sub>3</sub> —Input i.f. trans. Range of trimmers 53-97 μfd. each
108200	T <sub>4</sub> , C <sub>17</sub> —Output i.f. trans. Range of trimmers 39-71 μfd. each
105127	T <sub>5</sub> —Output trans.
125153	S <sub>1</sub> —Line-battery sw.

—50—

In the Circuit Page of July, 1947, page 71, the circuit diagrams for the Coronet Model C-2 and the Crosley Models 56PA, 56PB were inadvertently switched. Please make this correction.

# SPECIALS from "ARROW"

## BC-612

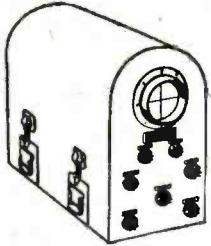

Modified BC-412, 5" Radar Oscilloscope; ideal for first class laboratory instruments; 110V 60 cycles, complete with tubes and power supply brand new in original cartons.

Each... \$49.95

## ARMY AIRCRAFT RECEIVER Model BC-946-B

Broadcast band from 520 to 1500 kc. Tube complement: 3—12SK7, 1—12SR7, 1—12A6, 1—12K8. Designed for dynamotor operation, but is easily converted to 110 or 32 volt operation. Has two I.F. stages and three gang condenser. Comes packed in sealed carton complete with tubes and instruction manual, but less dynamotor.

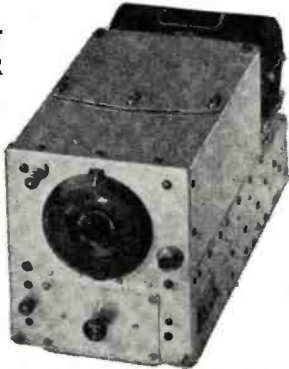

## RADIO RECEIVERS

BC-454-A; 3-6 mc complete with tubes... \$3.95  
 BC-453-A; 190-550 kc complete with tubes \$4.95  
 BC-455-A; 6-9 mc complete with tubes... \$3.95  
 All above used, in A-1 condition.

Brand new in original cartons... 5.95

## ARA NAVY RECEIVER

1.5 to 3 Meg. \$4.95  
 Used, in A-1 condition. Complete with 6 tubes.

## DYNAMOTOR

DM 32A. Each 95c, 3 for \$2.00

## MODULATOR UNIT

BC-456-A \$2.95

## REMOTE CONTROL BOX

BC-450-A \$1.95

## ARB AIRCRAFT RADIO RECEIVER

The ARB is a six tube, four band, superheterodyne Aircraft Radio Receiver with built-in dynamotor, designed for the reception of MCW (tone or voice) or CW within the frequency range 195 Kc to 9.05 megacycles. \$16.95  
 Used.

## AN18/APT-10

Pre-amplifier model K-1, designed to raise output level of magnetic type microphone, complete with 2 tubes 6SL7GT and 28D7 and hand switch, brand new in original cartons.

Each \$1.95 3 for \$5.00

## ART-13 TRANSMITTER

Used, in good condition, complete with tubes and calibrating crystal, freq. range 2,000 Kc to 18 mc: A-1, A-2, A-3 type transmission; power output 100 watts. Each \$75.00

## RAX-1 3-RECEIVER COMBINATION

No. 1—4 bands, tunes from 200-1500 kc. ea. \$15.00  
 No. 2—4 bands, tunes from 1500 kc to 9 mc. ea. 15.00

No. 3—5 bands, tunes from 7 to 27 mc. ea. 19.95  
 Each receiver complete with tubes and 24 V Dynamotor. Used, A-1 condition. 3 Receiver combination... complete \$34.95

## BC-929-A

Contains power supply 110 V, 400 cycles, has 7 tubes such as 3CP1, brand new, complete with tubes. Each... \$17.95  
 Used, ea. 14.95



## APS-15

Has 45 tubes, one 5" scope tube, one 2" scope tube, has 3 meters, 4 power supply units 110V 400 cycles, complete with tubes. Each... \$39.50

## BC-348 RECEIVER P or Q

Brand New in original cartons... \$49.95

## VHF RECEIVER BC-701

Frequency range 170-180 Mc; IF 30.5 Mc; complete with 11 tubes; self-contained power supply. Brand new in beautiful wooden carrying case. \$9.95

## BC-404-C VHF RECEIVER

Frequency range 102-110 Mc; complete with 12 tubes, 110V 60 cps, power supply included. Brand new in original cases. \$19.95  
 Used \$14.95

## NAVY GLIDE PATH RECEIVER

Bolt type, complete with 3 6C6 tubes and tunes from 90 to 95 Mc, operates from 12 or 24V. Brand new \$2.95

## RANGER MODEL 114-C AIRCRAFT RECEIVER

Combination Interphone, Amplifier and 6-Tube Superheterodyne Receiver designed to operate directly from a 24V aircraft battery. Tuning range 200 kc to 550 kc. complete with mounting rack, jackbox and cords. This unit is used as range receiver and interphone amplifier. Brand new... \$14.95

## GF12 and RU 17 NAVY RECEIVER and TRANSMITTER

Complete with receiving and transmitting coils, junction box, control boxes, plugs, power supply, instruction manual and spare parts which include tubes. Brand new in original carton. A real buy... \$24.95

## GO-9

Navy type low and high frequency transmitter with power supply and tubes. Operates from 200 Kc to 18,100 Kc; requires 115V, 800 cycles. Used, complete with tubes... \$39.50

## HAND-TYPE MICROPHONE RS-38

Carbon type, with PL-68 plug, brand new... \$1.95  
 Used... 1.00

## MICROPHONE AND RECEIVER P-60

Dynamic type, 50-ohm impedance; mike and phones interminate in 5-wire male plugs, 3-ft. cord... \$1.49

## OXYGEN MASK MICROPHONE T44C

Used with SCR-522, magnetic type complete with JK-26 and PL-179. NEW... Ea. \$1.29

Wholesalers, dealers, institutions and other quantity purchasers... Write, Wire, Phone for Quantity Prices. All Shipments F.O.B. Chicago—20% Deposit Required on all orders. Minimum order accepted \$5.00.

WRITE FOR OUR COMPLETE CATALOG

DEPT. C

## SCOOP of the Month!

### RCA AVT-112A Aircraft Transmitter

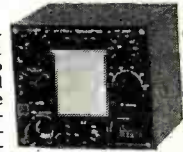

For radio-telephone communication; for 6, 12 or 24 volt source; band of from 2,500 to 6,500 Kc. Small in size and wt. (wt. 6 lbs.). Complete with 6 tubes, oscillator circuit, power amplifier modulators, dual tuning indicator and amplifier, with instruction manual, less crystal. BRAND NEW IN ORIGINAL CARTONS—ONLY \$12.95 each

### APN-9 RADIO RECEIVER INDICATOR UNIT

Complete with SELF-CONTAINED POWER SUPPLY; 29 tubes and 3" scope tube; 110 V. 400 cycles; used, but in excellent condition... \$29.95

Power Supply for the APN-4; complete with 16 tubes; 110 V. 400 cycles... \$14.95

RADIO TRANSMITTER MODEL BC-458  
 Tunes from 5.3 to 7 mc, complete with tubes and crystal. Brand new in original cartons... \$5.95

### SETCHELL CARLSON RADIO RECEIVER BC-1206-C

Designed to receive A-N beam signals. 24-28 vdc 21.6 watts. Tube complement: 14H7 or 14A7, RF amplifier; 14H7 or 14J7, mixer; 14A7 or 14H7, IF amplifier; 14R7, detector and 1st audio amplifier; 28D7, output amplifier. 195 to 420 kc. 4" high x 4" wide x 6 1/2" long—wt. 3 lbs., 4 oz. Used A-1 cond... \$4.95

BRAND NEW in original carton... 7.95

### RADIO TRANSMITTER and RECEIVER APS-13

Light weight air-borne radar system, radio transmitter and receiver APS-13; tube complement: 5—6J6, 9—6AG5, 1—VR105, 2—D21; unit is brand new, complete with tubes, the tubes alone are worth more than this LOW PRICE OF \$15.00 ONLY

### GLIDE PATH RECEIVER R-89/ARN-5

Glide Path Receiver used in the Instrument Landing System covering the frequency range 332 to 335 mc; complete with the following tubes: 7—6AJ5, 1—12SR7, 2—12SN7, 1—28D7, and including three crystals 6497KC, 6522KC, 6547KC units are in A-1 condition for ONLY \$9.95

### SCR-522 TRANSMITTER and RECEIVER

The standard very-high frequency airborne receiver transmitter. 100 to 156 megacycles. 4 channels selected from remote control box. Used, in good condition—"Complete with Tubes" \$19.95 ONLY

### BC-625

VHF transmitter, frequency range 100-156 Mc; four channels. Part of the SCR-522. Complete with tubes less crystals. Used, good condition... ea. \$10.95

### BC-624

VHF Companion receiver for above transmitter. Complete with tubes less crystals. Used, good condition. Diagram with either unit included... ea. \$9.95

### VEEDER-ROOT METER AND CASE

Counts up to 1000. Each... 95c

### WESTON OUTPUT METER No. 687

3 scales 0-50. A-1 Condition... ONLY \$6.95

**ARROW SALES, INC.**  
 59 WEST HUBBARD STREET • CHICAGO 10, ILLINOIS  
 Telephone: SUPERIOR 5575

# RADIOMEN'S HEADQUARTERS \* WORLD WIDE MAIL ORDER SERVICE!!!

## BC-947A ONE KILOWATT HIGH FREQUENCY TRANSMITTER

This relay-controlled transmitter includes a 115V, 60 cycle power supply, protected by 3 magnetic circuit breakers, that alone is worth more than the price we are asking for the whole rig, even on today's surplus market. On the front panel are six 3 1/2" GE or Weston meters, including 250 MA, 50 MA, 1000 MA, 150V AC, and 1500V DC at 1000 ohms per volt for screens and plate. The rack-type 21" x 15" x 36" unit contains six amplifier and rectifier tubes aggregating over \$60.00 at WAA current wholesale prices. Western Electric's price to the government was \$1500.00. Shipping weight 500 lbs. Your cost, as is, only \$69.95.

## ARMY BC 312 COMMUNICATIONS RECEIVER

This receiver covers the frequency range of 1.5 MC to 18 MC in six direct reading bands. The dial, that is driven with split gears to prevent backlash, has 4500 logging divisions per band with approximately 600 divisions on the 20 and 40 meter ham bands and 1000 divisions on 80 meters. Two stages of RF before the converter in this set give it a very high signal to noise ratio and maximum sensitivity. Outstanding features of this receiver are: BFO with pitch control, send-receiver relay, jacks on the front panel for headphones and speaker output and mike and key input, all tubes are standard 6 volt types. This receiver was designed to withstand rough usage in the field and for operation from vehicles while in motion, so it is ruggedly constructed and contains a dynamotor power supply.—Your cost \$49.95. Conversion kit to 110 VAC is available for \$6.50.

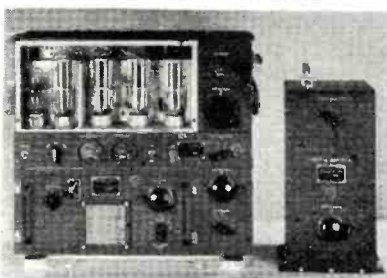

## GENERAL ELECTRIC 150-WATT TRANSMITTER

Cost the Government \$1800.00  
Cost to you \$44.50!!!

This is the famous transmitter used in U. S. Army bombers and ground stations, during the war. Its design and construction have been proved in service, under all kinds of conditions, all over the world. The entire frequency range is covered by means of plug-in tuning units which are included. Each tuning unit has its own oscillator and power amplifier coils and condensers, and antenna tuning circuits—all designed to operate at top efficiency within its particular frequency range.

Transmitter and accessories are finished in black crackle, and the milliammeter, voltmeter, and RF ammeter are mounted on the front panel. Here are the specifications: **FREQUENCY RANGE:** 200 to 500 KC and 1500 to 12,500 KC. (Will operate on 10 and 20 meter band with slight modification.) **OSCILLATOR:** Self-excited, thermo compensated, and hand calibrated. **POWER AMPLIFIER:** Neutralized class "C" stage, using 211 tube, and equipped with antenna coupling circuit which matches practically any length antenna. **MODULATOR:** Class "B"—uses two 211 tubes. **POWER SUPPLY:** Supplied complete with dynamotor which furnishes 1000V at 350 MA. Complete instructions are furnished to operate set from 110V AC. **SIZE:** 21 1/2 x 23 x 9 1/4 inches. Total shipping weight 200 lbs., complete with all tubes, dynamotor power supply, five tuning units, antenna tuning unit and the essential plugs. These units have been removed from unused aircraft and are guaranteed to be in perfect condition.

## GENERAL ELECTRIC RT-1248 15-TUBE TRANSMITTER-RECEIVER

**TERRIFIC POWER**—(20 watts) on any two instantly selected, easily pre-adjusted frequencies from 435 to 500 Mc. Transmitter uses 5 tubes including a Western Electric 316 A as final. Receiver uses 10 tubes including 955's, as first detector and oscillator, and 3 7H7's as IF's, with 4 slug-tuned 40 Mc. IF transformers, plus a 7H7, 7E6's and 7E7's. In addition unit contains 8 relays designed to operate any sort of external equipment when actuated by a received signal from a similar set elsewhere. Originally designed for 12 volt operation, power supply is not included, as it is a cinch for any amateur to connect this unit for 110V AC, using any supply capable of 400V DC at 135 MA. The ideal unit for use in mobile or stationary service in the Citizen's Radio Telephone Band where no license is necessary. Instructions and diagrams supplied for running the RT-1248 transmitter on either code or voice, in AM or FM transmission or reception, for use as a mobile public address system, as an 80 to 110 Mc. FM broadcast receiver, as a Facsimile transmitter or receiver, as an amateur television transmitter or receiver, for remote control relay hook-ups, for Geiger-Mueller counter applications. It sells for only \$29.95 or two for \$53.90. If desired for marine or mobile use, the dynamotor which will work on either 12 or 24V DC and supply all power for the set, is only \$15.00 additional.

## BRAND NEW BC 348 COMMUNICATIONS RECEIVER

Featuring coverage from 200 to 500 Kc. and 1500 to 18000 Kc. on a direct reading dial with the finest vernier drive to be found on any radio at any price—high sensitivity with a high degree of stability—crystal filter—BFO with pitch control—standard 6 volt tubes. Contains a plate supply dynamotor in a compartment within the black crackle finished cabinet, the removal of the dynamotor leaves plenty of room for the installation of a 110V, 25 or 60 cycle power supply. These receivers, which make any civilian communications receiver priced under \$200.00 look cheap and shabby by comparison, are only \$69.95 brand new. Power supply kit for conversion to 110V 25 or 60 cycles is only \$8.50 additional.

RT1463 7 tube amplifiers containing 3-7F7, 1-7Y4, 3-7N7, 4 potentiometers, numerous resistors, filter and bypass condensers, filter chokes, power and audio transformers, and six sensitive plate circuit relays. A military development that provided amazing stepless control proportional to correction required, for ailerons, rudder and elevator. In the original application. A control amplifier of the ordinary type would deflect the rudder by some arbitrary amount when the ship was blown off the course to port or starboard. The result would either be that the correction was insufficient and the plane continued off course, or the correction would be too great, starting a series of tacks that would greatly increase fuel consumption and elapsed time in reaching the objective. This phenomenal unit, with its 3 amplifiers and six 5000 ohm relays in bridge circuits, will accurately control any 3 operations, related or unrelated, in minutely adjustable uniquely quantitative variations in either forward or reverse directions. 9"x7"x8" black crackle aluminum case. Brand new in original carton \$12.95, or used \$9.95.

Minimum order \$3.60—All prices subject to change.—25% deposit with C.O.D. orders

## SERVICEMEN

Check This Column for Lowest Pr.ces on Quality Parts

**TUBES:** all types in stock, 60% off on all tubes if ordered in lots of 10 or more.

**POWER TRANSFORMERS**—Half-shell type, 110V 60 cy. Centertapped HV winding. Specify either 2.5 or 6.3 filament when ordering.

For 4-5 tube sets—650V, 40MA, 5V & 2.5 or 6.3V.....\$1.49

For 5-8 tube sets—650V, 45MA, 5V & 2.5 or 6.3V..... 1.75

For 6-7 tube sets—675V, 50MA, 5V & 2.5 or 6.3V..... 1.90

For 7-8 tube sets—700V, 70MA, 5V & 6.3 or two 2.5..... 2.35

For 8-9 tube sets—700V-00MA; 5V-3A; 2.5V-3.5A; 2.5-10.5A..... 2.85

For 9-11 tube sets—700V, 100MA, 5V & 6.3 or 6.3V-1A... 2.85

For 9-15 tube sets: 600V, 150MA; 5V & 6.3V..... 2.95

**TRANSFORMERS**—All types in stock. **AUTO-TRANSFORMERS:** Steps up 110v to 220v, or steps down 220v to 110v—\$1.95. **FIL. TRANS.:** 6.3r, 8 Amps.—\$1.98; 5v, 10 Amps.—\$1.98; Universal Output Trans. 8 Watt—89c; 18 Watt—\$1.29; 30 Watt—\$1.69. **AUDIO TRANSFORMERS:** S. Plate to S. Grid 3:1—79c; S. Plate to P.P. Grids—79c; Heavy Duty Class AB or B, P.P. inputs—\$1.49; Midget Output for AC-DC sets—69c; MIKE TRANSFORMER for T-17 Shure microphone, similar to UTC oncner type—\$2.00. **CONDENSERS—PAPER TUBULAR** 690 WV—.001; .002; .005—8c; .01; .05—1c; 1—10c; 25—23c; 5—36c. **ELECTROLYTICS:** 8mfd 200v—20c; 10mfd 35v—20c; 30mfd 150v—23c; 20/20mfd 150—35c; 30/20 150v—46c; 50mfd 150v—43c; 8mfd 475v—34c; 16mfd 350v—65c; **OIL CONDENSERS:** 4mfd 600v—49c; **BATH TUB TYPE CONDENSERS:** 3X.1mfd—20c. **RESISTORS:** All types in stock at the lowest prices; Resistor Kits—100 2 watt resistors—\$1.95. **FILTER CHOKES:** 200, 300, 400, 500 ohm light duty—59c; 200 or 300 ohm heavy duty—95c; 250 ma 35 ohm, made for U.S. Navy, fully shielded—\$1.95; 75 ohm 125 ma—25c or 25 for \$4.25; "Melssner type" tapped filter chokes—25c; 8 amp. iron core A filter—25c; Choke-condenser combination, ideal to replace any size speaker field when installing PM speakers—79c. **110 V. CIRCUIT BREAKERS** of Magnetic type: Following Current Ratings in Stock: 1.25, 3, 4, 8 Amps. Please Specify. \$1.95 each. Seven Assorted I.F. Transformers—\$1.98; Five Ass'd. Oscillator Coils—69c. **SPEAKERS-PM** dynamic type-4"—\$1.55; 5"—\$1.55; 6"—\$1.95; 8"—\$3.95; 10"—\$5.95; 12"—\$7.50. **HEADPHONES**—Highest quality Signal Corps headset with 12" cord and plug \$1.25. 5" rubber covered Datchcords with phone plug & socket—45c. **SELENIUM RECTIFIERS**—Dry disc type 1 1/2" by 1" 1.2 Amp. maximum, suitable for converting DC relays to AC, for supplying filament source in portable radios, converting DC meters to AC applications, and also may be used in low current chargers—90c. **METER RECTIFIERS**—Full wave, may be used for replacement, or in construction of all types of test equipment—\$1.25. Half Wave—90c. **LINE FILTERS**—110V—each unit contains two 2 mfd. oil filled condensers and a 15 amp. iron core choke. This filter has innumerable uses such as oil burner line filter, etc. A ten dollar value for 95c. **WILLARD** rechargeable 2v storage batteries for portable radios or any other purpose—\$2.95. **PUBLIC ADDRESS AMPLIFIERS**—25 watts peak output. This unit has separate input circuits for microphone and phono. The gain of the microphone circuit is 122 db. The phono circuit has a gain of 82 db. The frequency response is flat from 50 to 12000 cycles. A \$65 value for only \$32. Miniature pliers set contains one of each of the following: Needle nose, flat nose, parrot nose, standard nose. All contained in a leatherette case. Your cost—\$1.98. **ATR** battery eliminator. Handy for servicing car radios or any other purpose requiring 6 or 12v at 14 amps. Net price—\$36.00. **SOCKET WRENCH** set consisting of 5 sockets ranging in size from 3/16" to 1/2" and a handle 79c. **AUTOMATIC WIRE STRIPPERS** will strip up to 1000 wires per hour, a handy tool for any service job—\$3.50. Six Foot Asbestos Insulated Flat Iron Cords, one end has a male plug, the other end has a standard flat iron socket. Your price—70c each or 10 for \$5. **FREE!!! THIS MONTH ONLY.** A HIGH GRADE CRYSTAL PICK-UP WITH THE PURCHASE OF EACH PHONO MOTOR AT \$4.95.

**MICROPHONES**—All nationally known brands. Bullet crystal—\$5.45; Bullet Dynamic—\$7.45; Mike J.—60c; Shure Mike—90c; Label Mike—93c; **SHURE T-17 MIKES**, with push to talk switch—95c. **20 ASST'D COIL FORMS**, including 11 ceramic, 3 polystyrene, and 6 Aber, all useful sizes—50c. **VARIABLE CONDENSERS:** 350 MMFD, 5 gang—\$1.95; 4 gang—\$1.49; 3 gang—83c; 2 gang—79c; 7.5 to 20 MMFD, 1750v spacing, extra long shaft Hammarlund—69c; miniature variable—25 MMFD—39c; 50 MMFD—46c; 75 MMFD—59c; 100 MMFD—69c; 140 MMFD—79c. **TRANSMITTING RF CHOKES**, 4 PIE, 350 Ma.—25c or 5 for \$1.00. **INTERRUPTION FREQUENCY COILS** for super-regenerative receivers or the tremendously popular FM adaptors for standard broadcast sets. Iron core with a resonant frequency of 50 KC—39c; Air Core, 100 KC—29c. **30 MC IF TRANSFORMERS**, double slug tuned—25c. **VIDEO AMPLIFIER PLATE COILS**—Slug Tuned—25c. **REMOTE CONTROL UNIT:** Aluminum case 4x3x3/4" containing 2 potentiometers, triple pole switch, 4 knobs, gear mechanism, counter and phone jacks—59c. **MODULATION TRANSFORMERS:** 30 watt, open type—\$1.95; 40 watt, cast aluminum case—\$2.95; Class "B" input transformers, cast aluminum case—\$1.95; Transceiver audio transformers—85c; Transceiver modulation transformers—65c.

**BUFFALO RADIO SUPPLY, 219-221 Genesee St., Dept. 9N, BUFFALO 3, N. Y.**  
CABLE ADDRESS BUFRAD

**INTRODUCTORY OFFERING OF OUR OWN BRAND  
CAR RADIO ANTENNAS**

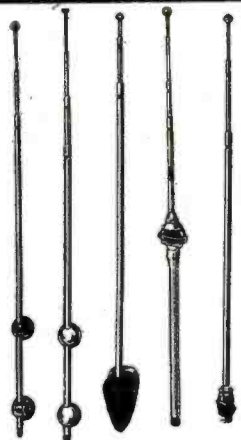

BR1 BR2 BR3 BR4 BR5

All of our car radio antennas are made of triple plated Admiralty Brass Tubing, complete with low loss shielded antenna leads and have high quality fittings.

**SIDE COWL**—BR-1, 3 sections extend to 66". Your price—single units—\$1.50; in lots of 12—\$1.35 ea.

**SKYSCRAPER**—BR-2 has 4 heavy duty sections that extend to 98". Your price—single units—\$2.45; in lots of 12—\$2.25 ea.

**TILT ANGLE**—BR-3, may be adjusted to all body contours. 3 sections extend to 66". Single unit price—\$1.50; 12 lot price—\$1.25 ea.

**VERSATILE**—BR-4, single hole fender or top cowl mounting may be adjusted to conform with all body contours. 4 sections extend to 56". Single unit price—\$2.90; 12 lot price—\$2.75 ea.

**THE MONARCH**—BR-5, single hole top cowl mounting, 3 sections extend to 56". Single unit price—\$1.90; 12 lot price—\$1.75 ea.

**BENDIX SCR 522**—Very High Frequency Voice Transmitter-Receiver—100 to 156 MC. This job was good enough for the Joint Command to make it standard equipment in everything that flew, even though each set cost the Gov't. \$2500.00. Crystal Controlled and Amplitude Modulated—HIGH TRANSMITTER OUTPUT and 3 Microvolt Receiver Sensitivity gave good communication up to 180 miles at high altitude. Receiver has ten tubes and transmitter has seven tubes, including two 832's. Furnished complete with 17 tubes, remote control unit, 4 crystals, 24 volt dynamotor and the special, wide band VHF antenna that was designed for this set. These sets have been removed from unused aircraft and are guaranteed to be in perfect condition. We include free parts and diagrams for the conversion to continuously variable frequency coverage in the receiver. The cost of this unit is only \$37.95. Brand new 12 volt dynamotor for SCR 522—\$12.00, 24 volt dynamotor—\$6.00. Used SCR 522, less dynamotor, remote control unit and antenna—as-is—\$19.95.

**PE-109 32-VOLT DIRECT CURRENT POWER PLANT**

This power plant consists of a gasoline engine that is direct coupled to a 2000 watt 32 volt DC generator. This unit is ideal for use in locations that are not serviced by commercial power or to run many of the surplus items that require 28-32 V. D.C. for operation. The price of this power plant is only \$100. We can also supply a converter that will supply 110v AC from the above unit or from any 28-32v DC source for \$29.95.

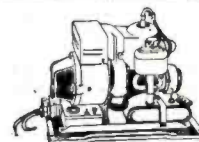

**AT LAST YOU CAN AFFORD A LABORATORY STANDARD  
SIGNAL GENERATOR**

The famous Measurements Corp. Model 78B, 5 Tube Laboratory Standard Signal Generator (currently selling new, FOB Boonton, N. J., for \$310.00 net), is available in perfect condition for 25 to 60 cycle, 115 V AC operation. Until now this is the sort of top-flight lab equipment that discriminating buyers have only vainly hoped would be released at a bargain price. Worth every cent the manufacturer asks, but available FOB Buffalo while our limited supply lasts for only \$79.95.

"REMEMBER THAT A STANDARD IS ONLY AS RELIABLE AS ITS MAKER." **LORAN INDICATOR OSCILLOSCOPE**, complete with 26 tubes and a 5" cathode ray tube, government instruction manual included—\$39.95.

**5" SO RADAR PPI OSCILLOSCOPE**, complete with 9 tubes. This unit contains magnetic deflection yokes and a Selsyn motor—\$39.95. **SO RADAR ECHO BOXES, THE PERFECT CALIBRATED CAVITY WAVEMETER**—\$10.00.

**5" SO RADAR PPI OSCILLOSCOPE**, complete with 9 tubes. This unit contains magnetic deflection yokes and a Selsyn motor—\$39.95. **SO RADAR ECHO BOXES, THE PERFECT CALIBRATED CAVITY WAVEMETER**—\$10.00.

**Range Unit RT-1579** consists of a three stage high gain, high fidelity amplifier and a Helmholtz coil for manually introducing phase shift from 0° to 360°. The amplifier is cascade 6SJ7s driving a 6F6 in the output, also on the same chassis is the 110v 60 cycle power supply. The Helmholtz coil is rotated by a vernier drive mechanism which has a dial that contains 4000 1/4 inch divisions. Your cost—\$14.95.

**RAYTHEON VOLTAGE REGULATOR**, will maintain a constant 115 V AC at the load even though the input voltage varies from 95 to 130 volts. The regulation is 1/2 of 1% with a 75 watt load. Shipping weight 20 pounds. Your cost \$8.95.

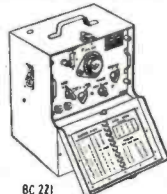

**SCR-610 TRANSMITTER-RECEIVER** ready to operate on 10 meter phone by connecting it to 6, 12 or 24 VDC—\$49.95.

**Relay Box BC-616** contains 3 high speed DPDT DC relays, that may be used as keying relays, resistors and a 150 MFD condenser. The aluminum box, with cover, measures 5 1/2 x 6 1/2 x 2 inches. While this terrific bargain lasts—\$1.95

**BC 221 FREQUENCY METERS** with calibrating Crystal and calibration charts. A precision frequency standard that is useful for innumerable applications for laboratory technician service man, amateur, and experimenter, at the give-away price of only \$39.95.

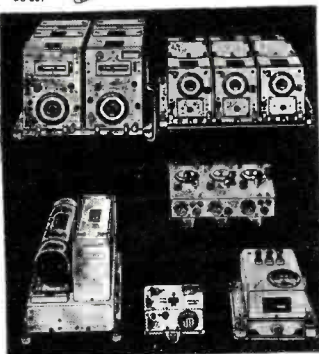

**SCR-274N COMMAND SET**

The greatest radio equipment value in history.

A mountain of valuable equipment that includes 3 receivers covering 190 to 550 KC; 3 to 6 MC; and 6 to 9.1 MC. These receivers use plug-in coils, and consequently can be changed to any frequencies desired without conversion. Also included are two Tuning Control Boxes; 1 Antenna Coupling Box; four 28 V. Dynamotors (easily converted to 110 V. operation); two 40-Watt Transmitters including crystals covering 3 to 4 MC and 4 to 5.3 MC; and Pre-amplifier and Modulator. 29 tubes supplied in all. Only a limited quantity available, so get your order in fast. Removed from unused aircraft and in guaranteed electrical condition. A super value at \$29.95, including crank type tuning knobs for receivers.

Minimum order \$3.00 - - - All prices subject to change - - - 25% deposit with C.O.D. orders

**BUFFALO RADIO SUPPLY, 219-221 Genesee St., Dept. 9N, BUFFALO 3, N. Y.**  
CABLE ADDRESS BUFRAD

**The BEST in SURPLUS**

- Collins AN/ART 13 Autotune 100 watt Transmitters. Brand new in original crates **\$99.50**
- BC 222 Walkie Talkies. Cover 28-52 Mc. Crystal calibrator, range 15 miles. Brand new. The ideal amateur portable unit **\$49.50**
- BC 457A Transmitters Western Electric 4-5.5 Mc. Brand new in sealed cartons with tubes **\$4.95**
- Mine Detectors SCR 625 in excellent used condition **\$19.50**
- BC 729C Antenna Tuning units from BC 610. Matches 500 watt transmitter to antenna made by Hallicrafters. Has O-15 RF Ammeter. Brand new **\$14.95**
- BC 306A Antenna Tuning Units. Mfg. by General Electric. Matches 150 watt transmitter to antenna. Brand new **\$3.95**
- 35' Mast Antenna, Steel, Sectional, with Guys, Base, 50' Coax Lead In, canvas case **\$29.50**
- Weston Model 155 Precision AC Voltmeter 0-30 volts, wood case, new **\$29.50**
- Weston Model 264 Precision Milliammeter 150-0-150 MA D.C. Bakelite case, new **\$19.50**
- Model 62 Measurements Corp. Precision Vacuum Tube Voltmeter used but like new **\$39.50**
- Westinghouse Type PX-14 Precision Milliammeter 50-0-50 MA DC. New sealed cartons **\$14.95**
- U.H.F. Loctal Sockets, Mica filled cinch 10 for **\$1.00**
- Thermocouple for R. F. Ammeters. Brand new 3 for **\$1.00**
- Kit of screw driver type Potentiometers 10 for **\$1.00**
- Kit of Metal Tubular Bypass Condensers 20 for **\$1.00**
- Kit of Bathtub Bypass Condensers 20 for **\$1.00**
- Technical Manual on BC312 and BC342 Receivers, instructions and circuit diagrams, etc. **\$0.50**

**Potentiometers Any 12 for \$2.50**

- Mallory 600 ohm 4 watt W.W. 1" Shaft
- Mallory 1000 ohm 4 watt W.W. 1/2" Shaft
- Mallory 5000 ohm 4 watt W.W. 3/4" Shaft
- W.E. 10,000 ohm 4 watt W.W. 3" Shaft
- C.T.S. 10,000 ohm Carbon 3/8" Shaft
- Mallory 20,000 ohm 4 watt W.W. 1" Shaft
- Mallory 25,000 ohm 4 watt 3/4" Shaft
- Clarostat 40,000 ohm 3 watt W.W. 1 1/2" Shaft
- Centralab 100,000 ohm carbon 2" Shaft

**29¢**  
EACH

**Any 12 above, 12 for \$2.50**

- Extension phone cords with plugs 6 ft. **\$0.25**
- Extension microphone cords with switch and plugs, 7 ft. **\$0.25**
- Kit of Relays, excellent assortment 5 for **\$2.50**
- Kit of Rotary Switches, Mallory, Centralab, etc. 5 for **\$1.00**
- 4.3 Mc. IF Transformers, double slug tuned. 25c, 5 for **\$1.00**

**We will ship C.O.D.  
No order under \$2.00**

**THE HEATH COMPANY**  
BENTON HARBOR, MICHIGAN

# Simple TROUBLESHOOTING AID

**A useful test instrument—it combines several practical servicing kinks into a single unit.**

By **SALVATORE J. MONDELLO**

**A** SIMPLE device which can be built quickly and inexpensively has proved to be a very useful and rugged test instrument in the radio repair shop. The idea is to combine various favorite and practical radio servicing kinks into one unit. Then by inserting test leads into the proper pin jacks, by trying the test prods across the various units in the receiver, a very convenient method for substituting parts by "cut and try" can be achieved.

The 8  $\mu$ fd. and 30  $\mu$ fd., 350 volt electrolytic condensers can be used to bridge open or leaky filter condensers in power supplies or power tube bypass electrolytics. Symptoms of such conditions include: bad hum, distortion, motorboating and low audio gain. If the receiver appears normal after this test you have located the defective condenser which should then be replaced by one of the correct value. In this manner the trouble can be located quickly and without annoying shocks to the serviceman or an accidental short across the rectifier plates which so often occurs when handling a large electrolytic while trying to get the leads across the defective one. The .05  $\mu$ fd. tubular can be used conveniently to bridge any suspected tubular of the approximate value in the set. In substituting a coupling condenser, unsolder one end of the condenser in the set, insert leads in the jacks connected to the .05  $\mu$ fd. tubular,

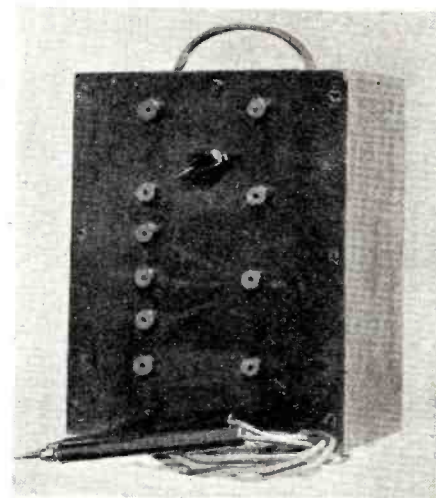

Over-all view of completed instrument.

and bridge the ends of the test leads from the plate of the detector to the grid of the power tube. With the test leads it is easy to "dig in" under a closely crowded spot without causing an accidental short. The 100  $\mu$ fd. mica condenser, although part of the crystal detector circuit, may be used across a suspected mica. This is particularly applicable to shorting or periodic oscillator grid leaks and in r.f. filters. For these tests it is best to prepare test leads with a clip on one end so that the prod may be held in

Diagram shows panel layout and circuits that are incorporated in this unit.

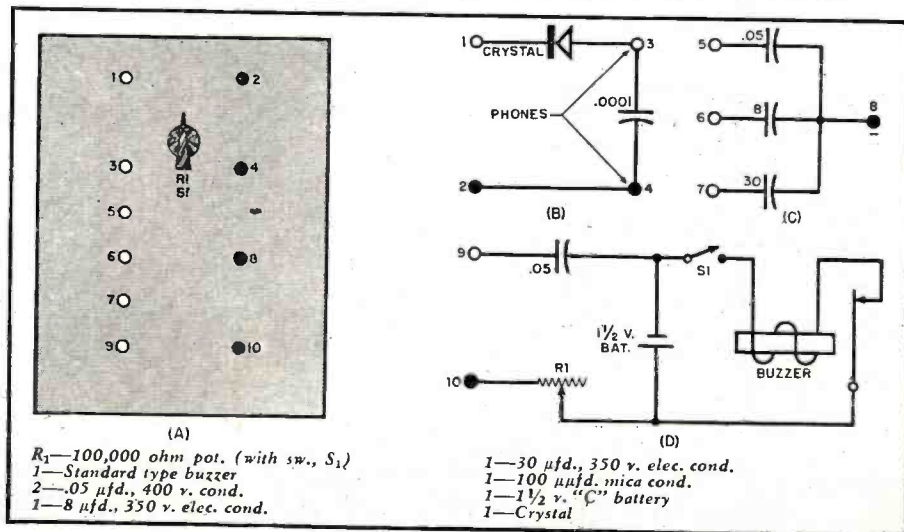



# ★ ★ *The* BEST in SURPLUS ★ ★

## HEATHKIT 5" OSCILLOSCOPE



Complete kit to build a beautiful 5" scope, cabinet, chassis and panel punched, formed and lettered. Every part supplied, including tubes with 5BP1, cased power transformer, oil condenser. Frequency compensated amplifier, 15 to 30 M cy. sweep, all controls, blueprint and instructions. This kit makes an excellent training course.  
Complete.....**\$39.50**

## OIL FILLED CONDENSERS

Bargain Prices on G.E., Pyranol, C-D, Solar, etc

CAP	W.V.D.C.	PRICE	CAP	W.V.D.C.	PRICE
4	500	\$ .49	4	1000	\$ .90
5	600	.59	8	1000	1.00
8	600	1.00	8-8	1000	1.95
2.5-2.5-5	600	1.50	8	2000	1.95
5-5-5	600	1.95	4	2000	1.50
8-8-8-8	600	3.95	2	2500	1.95
5-5	600	1.00	.05	7500	2.50

Write for list of high voltage condensers.

## PE 103A POWER UNIT



A 6 and 12 volt dynamotor complete with relays, filters, circuit breakers, switches and cables, supplies 500 volts at 160 mills. Ideal for mobile P.A. systems and transmitters. Lowest price ever offered.....**\$6.95**

## KITS

- Kit of ten ceramic variable air trimmers, 12 M.M.F. to 50 M.M.F.....**\$1.95**
- Kit of assorted mica and silver mica condensers, all marked..... **25 for 1.00**
- Kit of assorted ceramic condensers..... **20 for 1.00**
- Kit of Potentiometers long shafts, 6000 ohms to 200M ohms..... **10 for 1.95**
- Kit of tube sockets, miniature, octal, octal..... **20 for 1.00**
- Kit of power rheostats, 25 and 50 watt..... **6 for 2.95**
- Kit of 4 Dynamotors, easily converted to motors for fans, movie projectors, toy sets, etc..... **4 for 4.95**
- Experimenter's Kit, a paradise of condensers, coils, transformers, resistors, etc., all useful parts. **5 full pounds for 1.00**
- Resistor Kit, 1/2-1-2 Watt, all excellent sizes, color coded..... **100 for 1.95**
- Kit of Microswitches..... **3 for 1.00**
- Kit of amphenol connectors, excellent for converting military sets..... **10 for 1.00**
- Kit of bypass condensers, .01 to .25 MFD, 200 to 600 volts, all marked..... **15 for 1.00**
- Kit of toggle switches, SPDT, SPST, DPST, etc..... **6 for 1.00**
- Kit of vitreous resistors, 5 and 10 Watt..... **15 for 1.00**
- Kit of Selenium Rectifiers..... **4 for 1.00**
- Kit of transmitter crystals, assorted between 2000 and 6000 KC in holders..... **4 for 1.00**
- Kit of R.F. Chokes, excellent assortment **10 for 1.00**
- Kit of power, microphone and head-phone cords, rubber covered, with plugs..... **10 for 2.95**

## PUSH BUTTON TUNER

A ten push button assembly, operating a 4 gang silver plated variable condenser. Each shielded section has silver plated APC type ceramic air trimmers. Drum dial manual tuning. An outstanding surplus value at lowest price ever offered.....**\$2.50**



## TEST EQUIPMENT

Signal Generator—Measurements Corp. 78B, standard signal generator, covers 2 bands between 15-250 megacycles, new cost \$310.00, out price only slightly used...**\$39.50**  
BC221 Frequency Meters, cannot be told from new, complete.....**29.50**  
Send for Test Equipment List

## METERS



Weston, 2 1/2 0-60 amps DC, incl. shunt.....**\$2.95**  
Westinghouse, 2 1/2 0-240 amps DC, incl. shunt.....**2.95**  
G.E. 3 1/2 50-0-50 amps DC.....**2.95**  
Triplet Model 321 0-300 MA.....**3.45**  
Weston output meter 2" in wood case, used.....**1.00**  
Ammeter 0-6 amps 2" Flg. Mtg.....**1.00**  
Simpson 2 1/2 0-3V DC.....**1.95**  
Weston Model 507 2 1/2 0-1 amps RF.....**2.45**  
Meter Kit containing one R.F. Ammeter, one D.C. Voltmeter and one D.C. Milliammeter. Removed from air craft radios.....**4.95**  
Send for Meter List

## RG-8/U FLEXIBLE COAXIAL CABLE



RG-8/U is the ideal cable for feeding receiving and transmitting antennae for all frequencies up to 250 mc, and can be used up to 3,000 mc and down to dc. Priced at less than WAA wholesale. This is the last big lot—order while available.

Only 4¢ PER FT.

## MICA TRANS. CONDENSERS

CAP	W.V.D.C.	PRICE	CAP	W.V.D.C.	PRICE
.002	6000	\$3.49	.005	1200	\$0.39
.0002	5000	1.49	.02	1200	.59
.0001 ±2%	3000 A.C.	.75	.01	1200	.39
.002	2500	.69			

Send for list on high voltage micas.

## BC 223 TRANSMITTER

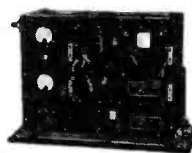

One of the most desirable military transmitters, 4 crystal-controlled frequencies and master oscillator. Meters for Osc., Ant., and total current. Uses 46 speech amplifier, 2-46 modulators, 801 each as oscillator and power amplifier. Practically no conversion necessary, plug in crystal, mike and connect power supply and it's ready to operate. Brand new, with tubes and tuning units.....**\$14.95**

## BC 455B RECEIVER

Six-Tube Western Electric superheterodyne, 3 gang condenser, R.F. stage, two I.F. stages, tunes 6-9.1 MC. Offered brand new in original carton for the price others ask for used war-weary sets, with six new tubes, 3-12SK7, 1-12SR7, 1-12A6, 1-12K8. Our price.....**\$4.95**  
Dynamotor for BC455B Each.....**\$1.95**

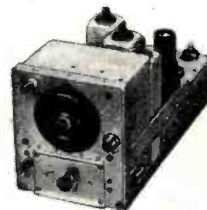

## TUBES

New Bulk Packed  
6SN7 6H6 6J5 }  
6SJ7 6J6 1G6GT } **49¢**  
6SL7 6AQ6 1LH4 }  
6SA7 6AK6 12C8 }  
6A6 3A4 1619 }  
6Y6 955 }  
3B7/1291 V.H.F. Twin Triode.....**\$1.50**  
3D6/1299 V.H.F. Tetrode.....**1.50**  
814 Transmitting Beam Power.....**3.95**  
6AC7, 6AG7.....**.89**  
Send for Tube List

## BC-605 INTERPHONE AMPLIFIER

The famous tank interphone, thousands bought for intercom communicating systems, call systems, etc. Uses two 1619 tubes (2.5V fil. 6L6's) used, in excellent condition, lowest price ever offered, with tubes.....**\$2.95**



## SPECIALS

- 455 KC slug tuned I.F.'s square can.**39¢, 3 for \$1.00**
- 4-gang 147 MMF silver plated variable condensers, long shaft, a buy at.....**1.00**
- Ceramic variable condensers, 50 MMF. Screw driver adj.....**Special 5 for 1.00**
- Choke, 20 henry 50 MA, cased.....**1.00**
- Choke, 10 henry, 200 MA, cased.....**1.50**
- HS30 miniature type headphones, similar to hearing aids with band and cord.....**1.00**
- 12 MFD 150V Mallory electrolytics, extra special.....**6 for 1.00**
- 8 MFD 450 Volt Illinois Cond. electrolytics.....**3 for 1.00**
- Power Transformer, 110V 60 cy. pri. from Hammarlund Super-Pro, cased, supplies 465V at 160 MA, 300V via at 11MA, 6.3V at 7.5A, 5V at 3A, and 5F at 2A. Ideal for PA systems and quality amplifiers.....**4.95**
- Power Transformer, 110V 60 cy. pri., General Trans. Corp., cased, 500V at 25MA, 6.3V at 3.25A, 5V at 2A.....**1.49**
- .01-600V paper tubular condensers.....**20 for 1.00**
- .05-600V paper tubular condensers.....**15 for 1.00**
- 16 position rotary switch with knob.....**.59**
- Interphone control box, BC606, contains potentiometer, pilot lite, switch, etc.....**2 for 1.00**
- Tuning Unit, BC-746, contains receiver ant. coil, tuning condenser, and crystal, transmitter crystal, slug tuned tank coil sockets, etc. Ideal foundation for Walkie-Talkie or small amateur rig.....**1.00**
- Dynamotors, Western Electric, 12V input, 220V at 80MA output in original carton.....**1.95**
- Dynamotors, Western Electric, 24V input, 220V at 80 MA output in original carton.....**1.50**
- Dynamotors, BD-77, 12V input, 1000V at 350 MA output.....**7.95**
- Circuit Breakers, G.E., 50 Amp. 220V 2 pole, in original carton.....**2.95**
- Lip Microphones in original sealed cartons.....**1.00**

*Free* AT 30 throat microphone with each order of over \$10.00.

NO ORDER UNDER \$2.00

WE WILL SHIP C. O. D.



# The HEATH COMPANY

BENTON HARBOR, MICHIGAN

# Whether RADIO AMPLIFIER or QUANTOMETER



PHOTO COURTESY RADIO STATION WOR & WESTERN ELECTRIC

Cannon Electric Type DPB Connector using gold-plated contacts in Studio Control Booth Console, Type 120 Amplifier in the low level side. Plug-in connector greatly increases ease of servicing and maintenance.

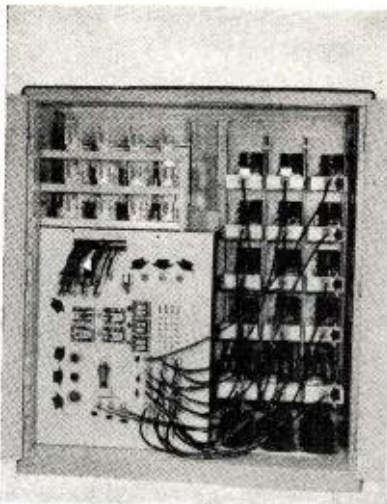

PHOTO COURTESY APPLIED RESEARCH LAB., GLENDALE, CALIF.

Arrows point to Cannon Electric Type "K" fittings connecting a maze of circuits on the Quantometer, a direct-reading spectrometer which determines chemical analysis of metals in 45 seconds. Rear view shown.

## Plug-in with CANNON PLUGS



K-21 Plug



RK-24C Plug

**TYPE "K"**—made in 3 general shell types with nearly 190 insert arrangements available for a wide variety of wire sizes, including coaxials.



**TYPE DPB**—rack type pin and socket assemblies (both for fixed mounting) carry standard, coaxial and twinax contacts. Six basic layouts available in DPB, many more in the larger DPD shell size.



**NEW EDITION C-46-A CATALOG**—For a complete survey of the majority of Cannon Electric products, send for this C-46-A Catalog, containing prices on many items. Also included are the names and addresses of our distributors. Write Department J-228.



### CANNON ELECTRIC DEVELOPMENT COMPANY

3209 Humboldt Street, Los Angeles 31, California

Canada & British Empire—Cannon Electric Co., Ltd., Toronto, Ontario • World Export Agents (excepting British Empire) Frazar & Hansen, 301 Clay St., San Francisco 11, Calif.

place directly across the condenser being substituted.

The crystal detector circuit uses a Philmore "fixed" crystal detector and is designed for signal tracing r.f. circuits. The output may be heard either through a pair of earphones or by means of an audio amplifier with a small speaker. The phones or amplifier are connected from the pin jacks at the top of the box. In signal tracing the first tank circuit the rectified signal will be weak or not heard at all since it is not amplified at this stage. To remedy this situation the receiver should be connected to a strong outside antenna. When working with the crystal detector signal tracer circuit, this will strengthen the signal and allow it to be heard in the headset or amplifier. Of course one of the input test leads should be connected to ground and the other probed back progressively from antenna primary to the detector of the receiver being tested.

The buzzer circuit is used for signal injection at various stages of the receiver being tested to locate "dead" stages or points where the signal is being blocked. In this case one lead is grounded to the set and the other probed back from speaker voice coil to antenna. The output of the buzzer can often be effectively used to actually "blow open" stubborn intermittents since the signal generated is very strong, irregular, and choppy, thus producing a great variation of frequencies and harmonics. By placing the lead at the mixer grid of a superhet, the i.f.'s can be aligned with good results and maximum response. The volume control in this circuit is used as an "on-off" switch and an attenuation control when aligning the i.f.'s. A sensitive receiver should pick up the generated buzzer noise without the leads being connected to the instrument. In this way you can determine the sensitivity of a receiver by slowly moving the instrument away from the receiver while the buzzer is on. This is especially helpful when a location, such as tall buildings with a steel framework, is suspected of shielding radio signals.

This handy test unit is housed in a box, which may be of any suitable size, but large enough to accommodate the battery and buzzer.

After the unit has been completely wired and before the cover of the box is fastened down, cotton should be packed around the buzzer in order to muffle its sound. The usable signal should be that which is picked up from the end of the test prod. Four rubber cushions or grommets should be used to support the bottom of the box in order to eliminate, as much as possible, vibrations which might occur when the buzzer is being used. The battery used to power the buzzer is an ordinary 1½ volt dry cell. The cover of the buzzer should be removed leaving the coils and vibrating hammer exposed, thus when the box is stuffed with cotton the buzzer will operate without noise.

**RADIO NEWS**

**POWER TRANSFORMER**  
1600v-0-1600v, 350 ma. Gov't rating. **\$12.95**  
7x6 1/2 x 5 1/4 - 31 lbs.



G.E.—Rotary Switch, 2 deck—each deck SP3P Mycel wafers. Can be used in HI-frequencies up to 250 Mcs. Perfect for band switching in an exciter or final. Heavy silver plated spring contacts. Positive action by spring controlled roller bearing. **\$1.29**

**TRANSFORMERS—115v 60 cyc**

**Hi-Voltage Insulation**

1600v @ 4ma; 700VCT @ 150ma; 6.3v @ 8a.	\$8.50
2500v @ 10ma.	6.50
3710v @ 10ma; 2.5v @ 3 amp; 2.5v @ 3 amp.	9.95
3950v @ 4ma; tap at 1250v @ 1ma.	7.50
550-0-550v @ 150ma; 5v @ 3a; 2X-6.3v @ 5a	7.95
6300v @ 4ma.	9.95
500-0-500v @ 100ma; 5vct @ 3a.	4.95
442-0-442v @ 1000ma.	9.95
425-0-425v @ 150ma; 6.3v @ 7.5a; 6.3v @ 3a;	5.95
5v @ 3a.	4.95
400-0-400v @ 200ma; 5v @ 3a.	4.95
350-0-350v @ 150ma; 6.3v @ 6a; 5v @ 3a; 78v	4.95
@ 1a.	1.49
350-0-350v @ 35ma—XLNT for Volt Doubler	1.49
300-0-300v @ 65ma; 2X-5v @ 2a; 6.3v @	3.49
2 1/2; 6.3v @ 1a.	2.49
120-0-120v @ 50ma.	3.95
2.5v @ 3a, 15KV test.	3.25
2.5v @ 10a, 10KV test.	14.95
5v @ 115a.	17.50
5v @ 190a.	3.25
6.3v @ 6.6a.	1.95
6.3v @ 3.1a.	6.95
6.3v @ 21.5a; 6.3v @ 2a; 2.5v @ 2a.	6.95

**FILTER CHOKES—  
HI-VOLTAGE INSULATION**

4 Hy @ 250ma.	\$1.98	12 Hy @ 300ms.	\$3.95
10 Hy @ 250ma.	2.49	15 Hy @ 100ma.	2.95
10 Hy @ 400ma.	4.95	15 Hy @ 125ma.	3.25
12 Hy @ 100ma.	2.95	30 Hy @ 70ma.	1.95
4 Hy @ 600ma.	5.95	1 Hy—5 amps.	6.95

**SCR-522 100-156 MC.  
RECEIVER AND TRANSMITTER**

Licensed for Railway and Taxicab Use

The ideal all-purpose transmitter-receiver for work in the 100-156 mc spectrum. Four channel push-button operation, crystal-controlled, AM, phone, mobile or fixed station service. Ideal for amateur, aircraft, marine, railroad, taxicabs, police and experimental. Amplitude modulated—High transmitter output. Receiver has 10 tubes and transmitter has 7 tubes including two 832's. Easily converted to full 110 volt 60 cycle operation. Complete conversion instructions and schematic furnished with each unit.

Tube complement 2—832; 3—12A6; 1—6G6; 2—6557; 1—12J5GT; 1—12C8; 1—9002; 3—9003; 1—12AH7GT and 3—12SG7.

Complete with tubes. **\$14.95**

**BC-348 RECEIVER**

Built for continuous duty, this band switching, six band receiver with a freq. range of 200 to 500 kc. and complete 1500 kc. to 18,000 kc. Has automatic noise compensator—constant sensitivity on all bands—output at 300 or 4000 ohms—xtal filter AVC-MVC-BFO; Smooth vernier tuning; 90 turns of tuning for each band. Complete with built-in dynamotor for 28 v DC. 8 tubes. Conversion instructions and schematics. **\$49.50**

Conversion kit for 110v-60 cyc. operation. complete. \$7.50

**'SILVER BALL' ANTENNA SWITCH**

100 Amp. 2500 V. Navy Rating

Terrific Buy **\$1.79**

**BLOWER**

Hi-air blast, designed for transmitting tube service. Motor operates on 100-125v 60 cycle at 7000 RPM. Noise free with self contained chokes and filters. Enclosed in satin finish, aluminum cabinet. Measures 4" high x 2 3/4 x 3 1/4" Many uses. **Super buy at \$5.95**

**PERMALLOY SHIELDS  
for  
CATHODE RAY TUBES**

3" Shield.	\$1.49
5" Shield.	1.98

**TUBES (Brand New)**

**Army-Navy Inspected**

1B24.	\$13.95	311.	\$ 5.95
2AP1.	2.25	371B.	5.95
2C40.	2.79	450TH.	44.50
2D21.	1.49	703A.	1.50
2V3G.	1.25	705A.	4.95
2X2.	.84	715B.	4.95
3AP1.	3.00	721A.	4.95
3BP1.	2.95	726/AC.	7.50
3E29.	2.95	801.	1.75
5BP1.	3.95	802.	1.75
5BP4.	4.95	803.	8.95
5CP1.	3.95	804.	9.95
5JP1.	9.95	805.	3.75
5LP1.	9.95	806.	14.95
5R4GY.	.98	807.	.95
5Y3.	.59	808.	2.95
6AB7.	.99	809.	1.50
6AC7.	.99	810.	3.50
6AG5.	.99	811.	1.95
6AG7.	.99	812.	3.95
6AJ5.	1.89	812H.	6.95
6AK5.	.90	813.	5.95
6AL5.	.99	814.	4.45
6AR6.	1.29	815.	3.95
6B4G.	1.29	826.	2.25
6C4.	.69	829-A-B.	3.00
6C5.	.49	832.	2.25
6F6.	.89	833A.	49.50
6F6G.	.59	834.	2.95
6J4.	1.50	835.	2.95
6J5.	.59	836.	1.75
6J6.	.89	837.	2.50
6L6.	1.25	838.	3.75
6L7.	.98	841.	1.20
6N7.	1.39	861.	89.95
6SH7.	.59	866.	.99
6SL7.	.89	872A.	2.50
6SN7.	.69	884.	1.10
6SR7.	.89	885.	1.10
7A4.	.95	902.	2.25
7B7.	1.25	913.	3.00
7L7.	1.59	954.	.75
9JP1.	14.95	955.	.75
10Y.	1.50	956.	.75
12X3.	1.50	957.	.75
15E.	1.50	958.	.75
24C.	1.75	959.	.75
28D7.	.75	1005.	1.98
30.	.75	1616.	2.95
35T/TG.	3.50	1619.	.75
VR90.	.75	1624.	.90
VR105.	.75	1625.	.75
VR150.	.75	1626.	.75
100TH.	7.95	8001.	8.95
100TS.	3.00	8003.	9.95
211.	1.25	8005.	4.95
250TH.	14.95	8011.	3.75
257B.	14.95	8016.	1.65
304TH.	9.95	8025A.	3.95
		F128A.	75.00

**SELENIUM RECTIFIERS**

**Full Wave Bridge Types**

INPUT	OUTPUT	
up to 18v A.C.	up to 12v D.C.	1 amp... \$1.95
up to 18v A.C.	up to 12v D.C.	5 amp... 4.45
up to 18v A.C.	up to 12v D.C.	10 amp... 7.45
up to 18v A.C.	up to 12v D.C.	15 amp... 9.95
up to 18v A.C.	up to 12v D.C.	30 amp... 14.95
up to 36v A.C.	up to 28v D.C.	1 amp... 3.45
up to 36v A.C.	up to 28v D.C.	5 amp... 7.45
up to 36v A.C.	up to 28v D.C.	10 amp... 12.95
up to 36v A.C.	up to 28v D.C.	15 amp... 18.95
up to 115v A.C.	up to 100v D.C.	25 amp... 2.95
up to 115v A.C.	up to 100v D.C.	6 amp... 6.95
up to 115v A.C.	up to 100v D.C.	5 amp... 19.95

**HIGH CAPACITY CONDENSERS**

4000 mfd.—18WVDC.	\$1.95
4000 mfd.—30WVDC.	2.95
1000 mfd.—15WVDC.	.99
2000 mfd.—50WVDC.	1.95

**OIL CONDENSERS:**

**G.E., AEROVOX, CD., ETC.**

**ALL RATINGS, D. C.**

1mfd. 600v.	\$0.35	2mfd. 2000v.	\$1.75
2mfd. 600v.	.35	3mfd. 2000v.	2.75
4mfd. 600v.	.60	4mfd. 2000v.	3.75
8mfd. 600v.	1.10	15mfd. 2000v.	4.95
10mfd. 600v.	1.15	1mfd. 2500v.	1.25
1mfd. 1000v.	.60	25mfd. 2500v.	1.45
2mfd. 1000v.	.70	5mfd. 2500v.	1.75
4mfd. 1000v.	.95	05mfd. 3000v.	1.95
8mfd. 1000v.	1.95	1mfd. 3000v.	2.25
10mfd. 1000v.	2.10	25mfd. 3000v.	2.65
15mfd. 1000v.	2.25	5mfd. 3000v.	2.85
20mfd. 1000v.	2.95	1mfd. 3000v.	3.50
24mfd. 1500v.	6.95	12mfd. 3000v.	6.95
25mfd. 2000v.	1.05	2mfd. 4000v.	5.95
5mfd. 2000v.	1.15	1mfd. 5000v.	4.95
1mfd. 2000v.	.95	1mfd. 7000v.	2.95

**HI VOLTAGE MICAS**

**ALL RATINGS, D. C.**

01 mfd. 15000v—	\$12.95	02 mfd. 12000v—	\$9.95
02 mfd. 20000v—	10.95	0005 mfd. 20000v—	9.95

**SCR-274-N COMMAND SET**

This unit consists of 3 receivers, 2 transmitters, 4 dynamotors, 1 modulator, 2 tuning control boxes, 1 antenna coupling box with RF ammeter, antenna relay and 5000v., 50 mmfd. W.E. vacuum condenser. Also complete set of 29 tubes with each unit. The receivers cover frequencies of 190-550 Kc; 3-6 mc; 6-9.1 mc; a calibrating crystal is also included. Each receiver has its own dynamotor and another dynamotor powers the transmitter and modulator. Terrific Value. Complete. **\$39.00** ready to operate.

**NEW SOCKETS**

Type 212 for RCA 833 or 833A. Type 234 for Western Electric 5D21, 705A, 715A, 715B. Raytheon RKR72 and RK72. Steatite base and special locking device for retaining tube in socket. Type 212. Net Price Each. **\$4.67**

Type 234. Net Price Each. **\$1.07**

All merchandise guaranteed. Mail orders promptly filled.  
All prices F.O.B. New York City. Send money order or check.  
Shipping charges sent C.O.D. Minimum order \$5.00.

**ATTENTION!**

**INDUSTRIALS—LABS—  
SCHOOLS—AMATEURS**

Let us quote on components and equipment that you require. We have too many items to be listed on this page. Place your name on our mailing list now for new catalog.

**RADIO HAM SHACK Inc.**  
63 DEY STREET • NEW YORK 7, N. Y.

# FLYING DISCS?



*Federated Values*

**ARE NO ILLUSION!**

If you're looking for "down-to-earth" values in communications receivers, SHOP AT FEDERATED! We maintain one of the largest, most complete stocks of standard brand receivers in the country. You're sure to find the set you want, in our stocks . . . and our competent, friendly technical personnel is at your service, to help you choose wisely!

Buy on

## TIME PAYMENTS

if you wish

Pay 20% down, balance in twelve monthly payments. Get the set you want now . . . pay for it later.

These are but a few of the models we stock—

All Available for Immediate Delivery

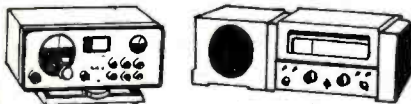

### HALLICRAFTERS

Model	Cash Price	Down Payment
S-38	\$ 47.50	\$ 9.50
S-40A	89.50	17.90
SX-42	275.00	55.00
SP-44	99.50	19.90
HT-9	350.00	70.00

### NATIONAL

NC-46	\$ 97.50	\$19.50
NC-173	179.50	35.90
J-10A	67.50	13.50
NC-240D	225.00	45.00
HRO	274.35	54.87

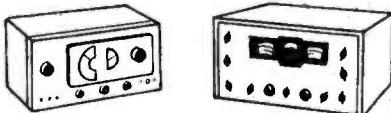

### HAMMARLUND

HQ-129X	\$161.40	\$32.28
SPC-400X	334.05	66.81

### RME

VHF-152	\$ 86.60	\$17.32
RME-84	98.70	19.74
RME-45	198.70	39.74

### MEISSNER

Signal Shifter	\$99.50	\$19.90
----------------	---------	---------

**Federated Purchaser**  
 INCORPORATED  
 Cable FEDERPURCH  
 distributors of RADIO-ELECTRONIC  
 and SOUND EQUIPMENT  
 80-NN PARK PLACE, N. Y. 7  
 Phone: WH 4-2080

Four black pin jacks and six red ones were set into the wooden cover. All of the components, including the condensers, crystal, and jacks, are mounted under this cover with the exception of the buzzer which is not fastened to the case in any way but merely lies on the cotton stuffing where it can operate freely without causing any unnecessary noise.

A multiple click switch, if one is available, can be used to eliminate the necessity for changing the test leads. This set-up is especially recommended for the condenser combination.

This entire unit was built in less than two-hours and cost only \$1.65 for parts. With this gadget it is possible to check receivers without using any other type of test equipment.

## RADIO REUNION

BY MAJOR HAL CONNER, USMC

"THIS is W6YB in Oceanside calling."

U. S. Marines in amateur radio stations throughout the Pacific hear these words each day and know that Marine Warrant Officer Charles D. Pierce of Camp Pendleton, Oceanside, California, is about to melt the 6000 miles separating Leathernecks from their families.

For over two hours each night Pierce sits at the microphone of his living room radio station in his home in Oceanside, California, and talks to Marine operators on Guam, Saipan and Hawaii.

Usually present at these broadcasts are the wives and children of Marines stationed there, who use Station W6YB to hold family reunions by radio. On other occasions, Camp Pendleton Marines and their families exchange news of local events with families stationed overseas.

Since he began operation of his radio station several months ago Pierce has contacted over 200 amateur broadcasters throughout the world.

Pierce built the transmitter himself. The first station that he talked to was operated by two G.I.'s occupying Japan. Most of the Marine's broadcasts are done on a regular nightly schedule with Guam, Saipan and Hawaii, although he often makes contact with amateur radiomen in China, Australia, the Marshall Islands, and other points.

The Camp Pendleton warrant officer, who is in charge of the low-speed radio operator's school here at the world's largest Marine training center, is an ex-prisoner of war. He was caught by the Japanese in Peking, China, when World War II started and spent nearly four years behind barbed wire in Shanghai and Kyushu, Japan.

Fourteen years ago, Pierce enlisted in the Marines. When he left "boot camp" at Parris Island, S. C., he was assigned to signal duty and has been a communicator ever since. He first went to China in 1934, where he was on duty as a radio operator at the American Embassy in Peking. Later, in 1938 Pierce was put in charge of the Marine amateur radio station on Guam and was there until shortly before December 7.

The Warrant Officer stated that he could talk to stations in Europe and the eastern United States only when it's daylight there. Early evening has proved to be the best time to contact Guam and Saipan inasmuch as it is noon the following day there.

"This is W6YB signing off."

When "Jack" on Saipan, "Joe" on Guam and "Stan" on Hawaii hear these words and close down their short-wave station they know that "Charlie" in Oceanside has made a lot of Marines happy by reuniting families, who otherwise would have had an ocean between them.

Marine Warrant Officer Charles D. Pierce, W6YB, provides radio reunions for Marine pals.



# SPRAGUE TRADING POST

**FOR SALE**—Philco table model receiver with speaker and tubes. Robert Rouse, 57 Water St., Geneva, Ohio.

**WANTED**—New or used Hallicrafter HT-6 transmitter. State price and condition. Les. Allen W2QK, 25 S. Warren St., Trenton, N. J.

**FOR SALE**—RME DB-20 preselector in perfect condition. Used only 3 months, \$35 prepaid. C. W. Wade, W3MKL, 1605 Palm Drive, Corpus Christi, Texas.

**WANTED**—Transformer similar to Stancor P-6318 that will deliver 250 and 400 volts at 200 ma. simultaneously. Cash or trade. Charles B. Remer, 838 Riverside Drive, New York 32, N. Y.

**FOR SALE**—Millen 50-watt transmitter, 90800, in black table cabinet with r-f amp, tubes, xtal and coils, but less power supply, \$50. Also Navy TBY-8 transmitter receiver and 6v power supply, \$25. F. Laughlin, 1040 Persia Ave., San Francisco 12, Calif.

**FOR SALE**—Prevar parts, 375-watt 4—20-10 meter c.w. transmitter—all good parts. Breting 12 receiver good condition. Reasonable. D. Shaw, 126 Elm Parkway, Lexington, Ky.

**FOR SALE**—Hallicrafters S-38 receiver in A-1 shape used only 3 months. Has wiring diagram. \$40. Antone L. Oliveira W1PWL, 94 Potomska St., New Bedford, Mass.

**FOR SALE**—R.M.E. 69 receiver good condition, complete less speaker; 838 tube never used but out of carton. Clarence A. Resch, Jr., WOFTD, 1214 West Maple Ave., Independence, Mo.

**SELL OR TRADE**—Holmes 16mm "H" projector complete with screen. Used only 30 days. \$490 or will take Meissner analyst and precision tube checker as part pay. J. A. Quarles, R 7, Box 78, Pine Bluff, Ark.

**FOR SALE**—Radio magazines and books; over 500. Write for list, Hillery, W2GNK/9, Elmwood, Ill.

**WANTED**—S22R receiver. State price and condition. Would like to trade 10 volume set. The Complete Photographer for radio books or what have you? Paul W. Kercher, 119 North St., Elkton, Md.

**FOR SALE**—Meissner B-150 transmitter with signal shifter, spare parts, data for conversion to 10-20 meters. Local buyers preferred, \$325. John J. Gillen, W3NFG, 2329 St. Albans St., Philadelphia 46, Pa.

**WANTED**—Communications receiver HQ129X, HQ120, SX25, SX28A, S40 in good condition. W. Littenberg, 731 Greenwich St., New York 14, N. Y.

**WILL TRADE**—National NC44 receiver and separate speaker in cabinet for good quality service oscillator in good condition or will sell for \$50 cash. George Moore, W3PFD, 907 14th St., Beaver Falls, Pa.

**WANTED**—Good used Hickok 49225 jumbo voltohmmilliammeter. A. J. Welter, Gonvick, Minn.

**WILL TRADE**—Complete Candler code system consisting of both be-

## DOUBLY SEALED AGAINST HEAT and MOISTURE

Sprague High-Voltage Paper Tubular Vibrator Condensers are especially designed in every respect to stand the severe conditions of auto radio operation. They're oil impregnated against intense heat. They're over-all wax dipped—and they've got special end seals for really top notch humidity protection. The working voltage rating of 1600V.



**SPRAGUE  
VIBRATOR  
CONDENSERS**

D.C. is honestly conservative. Capacity ratings mean exactly what they say.

Use 'em on all auto radio jobs—and other high-voltage applications as well. They'll stand the gaff! They will not let you down! As always, we'll appreciate it if you order them by name—*Sprague Type TR High-Voltage Paper Tubulars.*

ginners' and high-speed courses. Want transmitter parts. All letters answered. Daniel D. Lewis, 101 Constitution St., Emporia, Kans.

**WANTED**—Meissner 14-tube traffic master communications or similar receiver. State price and condition. R. E. Bond, 49 NE 110th St., Miami, Fla.

**WANTED**—Meissner 14-tube Traffic Master communications receiver or similar. State price and condition. Bond, 49 NE 110th St., Miami, Fla.

**FOR SALE**—BC-406 with speaker, for 110v. operation; 13 tubes inc., perfect condition. Partly converted for 5, 10 and 20 meters. Has heavy steel case. \$35 with speaker, line cord and plug. Peter H. Parkhurst, 2207 Shore Rd., Northfield, N. J.

**FOR SALE**—New 7-tube super-heterodyne, built as shown in 1946 Handbook. Complete with power supply, speaker, 80, 40, 20 and 10 meter coils and 21 x 21 wooden rack. Exceptional value \$25. B. E. Martin, 25 Martling Ave., Pleasantville, N. Y.

**WILL TRADE**—0-5 G-E r-f meter never used, for good used bug, any make. Hartwell B. Burner, W00EL, Mayville, N. Dak.

**WANTED**—Used SW receiver in good condition. Give complete description and price. H. L. Spence, Gen. Del., Winston-Salem, N. C.

**FOR SALE**—40-watt rig without tubes, power supply, crystals but with all plug-in coils for 40-80 meter band, \$15. Monitor \$3. F. Bou, W3ESX, 3131 N. Percy St., Phila. 33, Pa.

**FOR SALE**—RME-69 with black crackle matching speaker in excellent condition. \$100. W9LNQ, 6311 W. Grand, Chicago 39, Ill.

**WANTED**—HW-120X receiver in good condition. Will pay cash. Robert R. Payne, 145 Highland Drive, Williamsville 21, N. Y.

**FOR SALE**—National NC-46 with speaker good condition. Looks like new, \$80. John Jacezko, 4030 N. 9th St., St. Louis 7, Mo.

**FOR SALE**—Code practice machine in red leatherette covered case, complete with tapes, key, buzzer and batteries. Very good condition, \$10 postpaid. Vern Anderson, 304 Pine, Lewistown, Mont.

**WANTED**—FM and AM receiver R44/ARR-5S. Harold Francis, % Manasquan Police, Manasquan, N. J.

**FOR SALE**—Communications receiver, Navy surplus RAO-6 (same as NC-100XA except for additional T.R.F. stage). Standard coverage, 540kc to 30mc. Little used, \$80. H. Davies, 36 Jefferson Ave., Hasbrouck Heights, N. J.

**FOR SALE**—Supreme oscilloscope No. 530 with complete instructions. Good condition, \$35. L. K. Drum, 785 Mt. Vernon, Lake Orion, Mich.

**WANTED**—BC342 receiver or equivalent, Vomax, or first class tube tester. Will trade Winchester 54, .30-06 rifle with Redfield peep sight, sling, and ammunition. Complete descriptions exchanged. W4BVZ, Needham C. Crow, 312 Johnson St., New Bern, N. C.

**FOR SALE**—BC348 receiver for 100v, 60 cycles a-c with many improvements. \$65. James E. Kietzer, 2035 West Berwyn Ave., Chicago 25, Ill.

**WANTED**—Good used signal generator covering standard and short wave bands. Must include instruction manual and be reasonably priced. W. H. Davidson, Pendleton, Ore.

**FOR SALE OR TRADE**—McElroy 60w transmitter-exciter, built in eco, and all coils. Excellent condition.

Also dual power supply. Need 15-25 watt amplifier, signal generator, 1800v, 300ma transformer or what have you? G. H. Perry, W5LVX, Box 6743, L.S.U., Baton Rouge, La.

**FOR SALE**—Signal corps radio receiver BC-348-R converted for 110v. use; complete with speaker \$67.50. Charles Markham Morris, P.O. Box 294, Bastrop, La.

**SELL OR TRADE**—Transformers, output, mike and vibrator, various tubes, 1N23 crystals. O. John Zethmeier, 1123 Woodycrest Ave., New York 52, N. Y.

**FOR SALE**—BC-191, 150-watt phone/CV 40/80 meter transmitter easily changed to include 10/20 meters by altering coils, with 4 plug-in coils and 12 volt dynamotor, \$60. R. Shibe, 1103 Grandview Blvd., Kansas City, Kans.

**TRADE**—Class C airplane engine like new, 2 propellers, fly-wheel, coil, condenser, battery box and spark plug wrench for ham gear or what have you? Nile Smith, 316 W. Franklin St., White Hall, Ill.

**WANTED**—Diagram of model 54 General Television radio. Clarence Stinnett, 1721 Elm Ave., Lynchburg, Va.

**SELL OR TRADE**—Small sensitive relays, 5,000 and 8,000 ohm. Want other radio parts. Melvin Younguan, 515 South Blvd., Oak Park, Ill.

**SELL OR TRADE**—McMurdo Silver model 900 Vomax, used 3 weeks. Guaranteed — \$50 or good portable typewriter or ham receiver. James Lanterman, Box 609, Lake Charles, La.

**FOR SALE**—ACR-111 (RCA) 16 tube comm. receiver with 12" speaker, covers 550 kc to 30 mc. \$130 or will swap and pay difference for SX-28A. Robert F. Lindstaedt, 438-A 14th St., San Francisco, Calif.

**WILL TRADE**—Hallicrafters S-27 receiver, tuning 27-145 mc. for Hallicrafters S-27-B receiver, tuning 35-165 mc. in working order or repairable condition. Al. Birch, Box 13, Parkland, Wash.

**FOR SALE**—Eleven 9003 (vt-203) radio tubes (Ken Rad) and adapters for 50L6, 35A6. \$5. Williamson Radio Service, Copper, Texas.

### YOUR OWN AD RUN HERE FREE

The Sprague Trading Post is a free advertising service for the benefit of our radio friends. Providing only that it fits in with the spirit of this service, we'll gladly run your own ad in the first available issue of one of the six radio magazines in which this feature appears. Write CAREFULLY or print. Hold it to 40 words or less. Confine it to radio subjects. Make sure your meaning is clear. No commercial advertising or the offering of merchandise to the highest bidder is acceptable. Sprague, of course, assumes no responsibility in connection with merchandise bought or sold through these columns or for the resulting transactions.

**Dept. RN-97, SPRAGUE PRODUCTS COMPANY  
North Adams, Mass.**

(Jobbing distributing organization for products of the  
SPRAGUE ELECTRIC CO.)

**ASK FOR SPRAGUE CAPACITORS and \*KOOLOHM RESISTORS by name!**

\*Trademark Reg. U. S. Pat. Off.

# R & M RADIO COMPANY

1426 N. QUINCY STREET • ARLINGTON, VIRGINIA

## Famous "PUTT-PUTT"

(HRU-28) DC POWER SUPPLY  
24-28 VOLT at 70 AMPS—2000 WATTS

This unit is just fine for your Field Day, to operate your BC 375, ART/13 Collins trans., BC 348 Rec., and all your gear.

This gasoline engine generator power supply is a one-cylinder, two-cycle gasoline engine, approximately 4 horsepower. Automatic starting when 24-volt battery is attached. Voltage regulator adjustment can adjust from 12 volts to 35 volts, DC. Ideal power supply to operate all war surplus radio equipment (24 volt DC).

These units are slightly used but in excellent condition and guaranteed operative. Each power supply is given an operating test before being shipped. They are substantially crated for domestic shipment. Complete as shown; ready to operate.

"OPERATES EVERYTHING"

only \$6950

- STARTING AIRPLANE ENGINES
- CHARGES BATTERIES (FAST CHARGE)
- FARM IMPLEMENTS
- POWER MOWERS
- WELDERS

- AMATEUR RADIO STATIONS
- BOATS, LIGHT SYSTEMS
- FARM LIGHTING (AUXILIARY)

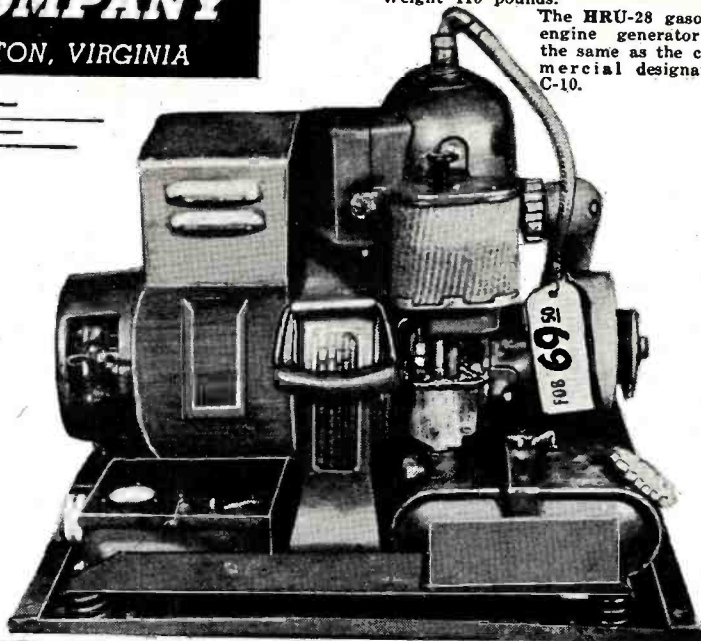

Over-all dimensions: Height 21 1/2 inches. Width 17 1/2 inches. Length 24 1/2 inches. Weight 115 pounds.

The HRU-28 gasoline engine generator is the same as the commercial designation C-10.



RADIO CONTROL BOX

BC-451. Two microphone jacks, four-position selector switch, telegraph key, and numerous other parts, all for \$1.50



BRAND NEW DIAMOND T BELTS

Length 52" OD dimensions. Ideal for driving dynamotors and generators and many other special jobs. Special each \$1.00

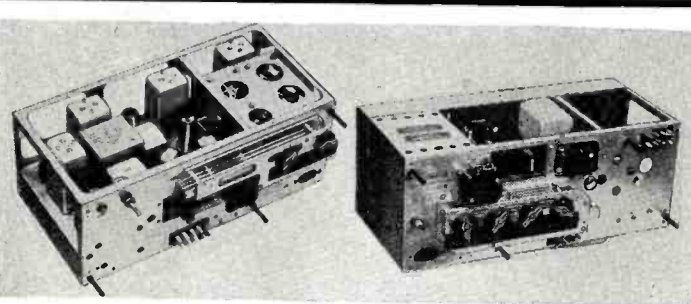

BC-624 VHF RECEIVER  
2 METER

10 tubes, 4 crystal channels, tunes from 100 to 156 mc. Excellent receiver for the VHF experimenter. Does a fine job on 144 mc. Makes basic unit for conversion of FM or television. only \$12.50

2 or 6 METER RADIO TRANSMITTER  
BC-625-A

The famous SCR-522 transmitter only, covers from 100-156 mc., crystal control, four crystal channels, seven tubes, two of which are 832's. 8 watts power output, 100% modulation, built-in modulator. Steady, reliable, beautifully made of finest components. Can be made to furnish 50 mc and 144 mc. Can be used as drive for any frequency above. only \$12.50

APN-4 RECEIVER-OSCILLOSCOPE POWER SUPPLY

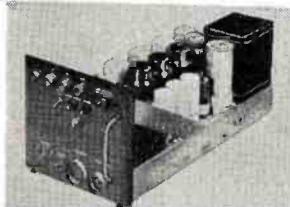

Has four screw driver tuned R.F. channels selected by switch— I.F. frequency 1050 kc, I.F. band width 45 to 60 kc, R.F. frequencies 1600 kc to 2000 kc. Tube lineup: (2) 2Y2, (1) 5U4, (3) 6B4, (1) 6SU7, (1) 6SA7, (4) 6SK7, (1) 6SN7, (1) 6SL7, (1) 6H6 and (1) VR150.

The components of this receiver are the finest money can buy. Makes excellent fixed tuner for medium frequency police calls or public address system. Has power supply for 5 inch scope—just the set to make a panoramic scope for those high frequency I.F. receivers—power transformer 400 cycle. Low voltage supply is electronically controlled and delivers 260 v.d.c. 150 mils regulated to .01%. The power supply alone is worth more than the price. Only \$18.25

APN-4 INDICATOR—PRECISION OSCILLOSCOPE

Special for radio amateurs, experimenters and radio repairmen. This APN-4 scope can be converted into a 5-inch panoramic set with marker pips at 100 kc - 20 kc - 2 kc - that will enable you to observe the crystal and V.F.O. drift and the width of frequency deviation of FM. A precision sweep scope that is accurate. It has within it an electronic switch that enables you to observe two signals simultaneously, and 100 kc lab. type crystal with TPTG oscillator circuit feeding six frequency divider stages. Tube lineup: (1) 5CP1, (3) 6SL7, (14) 6SN7, (6) 6H6 and (1) 6SJ7. Only \$38.50

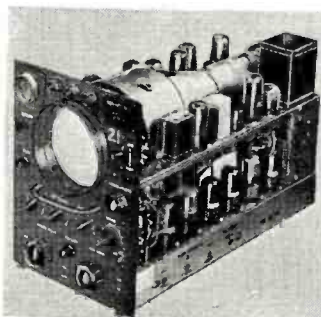

*note*  
All tubes and dynamotors furnished with all units.



T-17 CARBON MICROPHONE

Brand new, \$1.85 each. Used \$1.00 each.



HS-33 HEADPHONES

Headphone with extension cord approximately 72" long as shown. 600 ohms, brand new, \$1.50 each. Used, each \$1.69

HEADSET EXTENSION CORDS

Approximately 72" long, rubber covered with JK-26 and PL-55 plugs. Each \$2.5

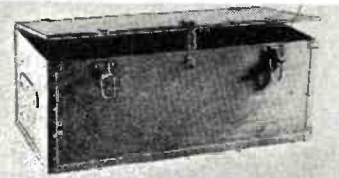

GI FOOTLOCKER— ALL WOOD

Hinge and clasp for lock. Ideal for tool chest and storing parts. \$2.75

# SAVE TIME!

*Free!*

A book full of schematic diagrams and conversion information on war surplus equipment such as BC-375-E, SCR-274-N, SCR-522, BC-221, APN-4, APN-1 and many others.

R & M Engineering Department has worked out the latest and many new ways to eliminate the worry and headaches of converting surplus equipment. This book contains wiring diagrams of each equipment and conversion information on how to adapt with wiring changes. One of these books *free* with each equipment you purchase. We have selected the most desirable and choice radio gear and present them to you with a **SATISFACTION GUARANTEE!** You save money when you deal with us.

## IMMEDIATE DELIVERY!

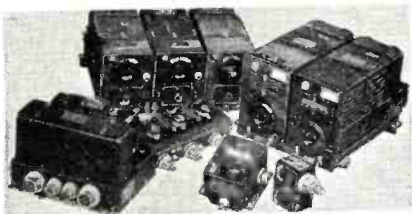

### SCR-274-N COMMAND SET COMPANION OR STANDBY

Here are a couple of things you can do with equipment included in the SCR-274-N Command Set. The transmitter VFO driver stage gives you the BC-375-E higher RF output—as high as 150 watts. Make swell standby receivers with the BC-348 on round table "rag chews." Includes all this equipment: 3 Receivers—190-550 kc, 3-6 and 6-9.1 mc; two transmitters, 4-5.3 mc, 5.3-7 mc; four dynamotors—28 volts DC input; 1 modulator with carbon mike input; two tuning control boxes; one antenna coupling box with r-f ammeter; antenna relay and 5000 volt 50 mmfd. WE vacuum condenser (antenna relay can be used with most rigs); and a complete set of tubes for each unit—29 POPULAR TUBES in all. Mechanical cables with tuning receivers supplied for \$1.00 extra. Complete diagrams and instructions on other conversions and uses furnished with set. only **\$19.50**

### 2 METER OR 6 METER RIG

The Army Air Force SCR-522 transmitter-receiver designed to operate from 100 to 156 mc. However, two small changes incorporated will easily convert to 6 meter operation.

When used as mobile unit or ground station, the dynamotor (supplied with set) has complete instructions for conversion to auto engine driven self-excited generator. Also used 115-volt AC, 60 cycle motor drive. Can be converted to FM receiving and transmitting. Furnished complete with transmitter-receiver, dynamotor, remote control box, plugs and tubes. only **\$24.50**

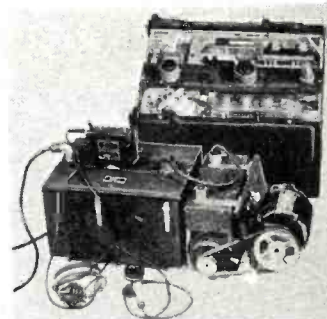

### BC-221 FREQUENCY METER

Here's something to add to your equipment. A heterodyne frequency meter complete with tubes and guaranteed accuracy of 0.01% or 500 cycles, whichever is greater. Dial readable one part in 50,000. Better than two dial division per kc. Fundamental ranges are 125-250 and 200-400 kc. Can be used with 110 volts AC power pack batteries, or vibrapack. Makes a fine signal generator—or converts to VFO.

Used ----- **\$39.50**  
 Brand New ----- **\$59.50**  
 With Modulation ----- **\$74.50**

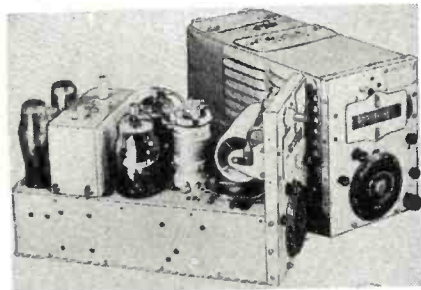

### VFO DRIVER—40 WATTS OUTPUT

BC-696-A 3-7 mc.....\$8.50 each  
 BC-457-A 4-5.3 mc.....\$6.00 each  
 BC-458-A 5.3-7 mc.....\$6.00 each

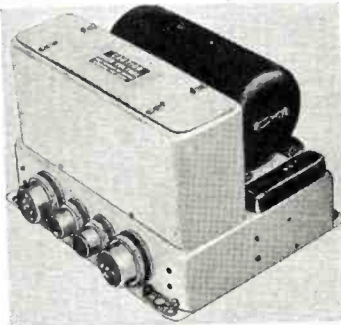

### SPEECH AMPLIFIER

Modulator for Transmitter, High Voltage DC Power Supply. Model unit, BC-456-A or V with dynamotor DM-33-A. Approximate wt. 17 lbs. Tube line-up, 12J5GT, 1625, VR150 and many other parts that make an ideal parts buy besides the above mentioned items. Diagram furnished. **\$2.75**



### ANTENNA SWITCHES

1. **\$1.19**      2. **\$2.29**      3. **\$7.75**

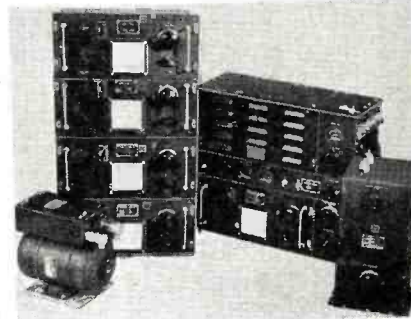

### ARMY AIR FORCE BC-375-E TRANSMITTER

It's been written about and talked about—just the thing for beginner or old-timer. Has five tubes, 5 tuning units. Transmitter designed to operate from 200 kc to 12 mc (less BC band). Equipped with antenna tuning unit—BC-306-A—variometer and tap switch. Dynamotor (PE-73-C) complete with relay, fuses and filter. Diagram and instructions for its use supplied with each set. Weight approximately 275 lbs. only **\$29.50**

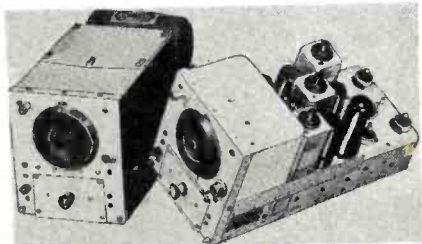

### BEAUTIFUL SUPER-HET RECEIVERS

Ideal companion or standby receiver for your shack. The following receivers are available:

BC-454 3-6 mc.....\$5.50 each  
 BC-453 190-550 kc.....\$5.50 each  
 BC-455 6-9.1 mc.....\$5.50 each

SAVE C.O.D. CHARGES BY REMITTING IN FULL DIRECT . . . TO R & M RADIO CO. . . . OR SEND 25% DEPOSIT ON ALL ORDERS

We save you time and money by shipping direct to you from our nearest warehouse . . . located in the East, Mid-West and West Coast.

### CASE CS-48

Storage case for 375 tuning coils. VERY HEAVY GAUGE ALUMINUM, smooth surface, black crackle finish, 7 7/8" x 16 3/4" x 7 29/32". These cases are tops for all around use as chassis. each **\$1.75**

# R & M RADIO COMPANY

1426 N. QUINCY STREET • ARLINGTON, VIRGINIA

**D&H HAS**  
**SUPER Values!**

**A REAL BUY!!**

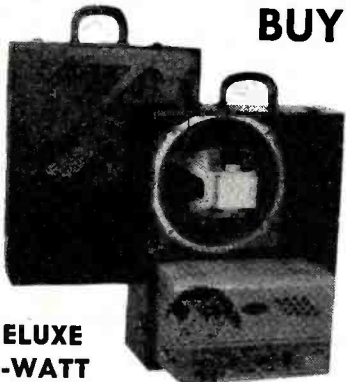

**DELUXE 35-WATT**

**AMPLIFIER with tubes**

2-12" P.M. Speakers—Alnico Slug Deluxe Portable Case (black leatherette). Completely mounted, ready to use. Only.....

**\$59.50**

**Accessories for above:**

Microphone—Dynamic 11Z, Special.....\$12.36  
Table Stand for above..... 1.50  
2-Wire Cable, Weatherproof, 250 feet.... 7.25

**BC-654A RECEIVER-TRANSMITTER**

Use it for While They Last

- PARTS
- TUBES
- TRANSMITTER
- RECEIVER

**\$14.95**

as is less dynamotor  
One-third deposit with order, balance C.O.D., F.O.B. shipping point.

**PARTS AND EQUIPMENT**

Siltronic Portable Amplifier complete with mike less batteries.....\$52.12  
Phono Motors with turntable..... \$3.75  
Alliance Non-Directional F.M. Antenna..... \$8.97  
Boren 2-way Intercom with cable  
1S-2 with switch.....\$24.60  
1S-2 less switch..... 23.10  
12" PM Speaker \$10.49 10" PM Speaker \$10.19  
SV 18/2 Service Cord, formerly \$8.75.....\$7.25  
Now 250 ft..... 5.25  
Zip Cord, POSSI, 250 ft..... 5.25

Ask for quotations on Sound Equipment. Every inquiry answered.

**It's D & H for Dependable Parts Service"**

**D&H**

RADIO PARTS DIVISION

**DISTRIBUTING CO., Inc.**

311 S. Cameron St., Harrisburg, Pa.

31 East Lee St., Baltimore 2, Md.

# Short Change Workers

By **HAROLD ZIEGLER**

**You can help stamp out short change rackets by being on the alert for these workers' methods.**

**T**HE SHORT CHANGE artists aren't mad at the radio and appliances dealers, and they'll visit you just as quickly and as often as they visit the corner grocery dealer, druggists, and other merchants and dealers.

Short change artists specialize in certain short change manipulations just as other types of criminals stay with their specialty, be it burglary, forgery, picking pockets, shoplifting, etc.

There are more than two dozen totally different forms of the short change racket. This article isn't meant to alarm you, but to acquaint you with the exact manner in which these various short change rackets are worked.

This article is being especially prepared for the readers of RADIO NEWS in an effort to prevent future losses by acquainting the radio and appliance dealer with each and every short change racket that has been worked on appliance dealers before and will be worked again.

As you know, millions of people tried to turn into short change artists overnight when the white pennies made their appearance. The government received so many complaints from merchants that they stopped minting them. This should serve as a warning as to *who* would try to short change you.

The following short change rackets are worked by two short change artists, which are usually a man and a woman instead of two men or two women. A customer will be looking around your accessory department and will eventually buy a radio tube or some other small part and will pay for it with a ten dollar bill. The next customer will quickly enter your store or come from another part of your store and will immediately and hurriedly make a small purchase and pay for it with a single.

The customer who gave you the single takes his change and quickly starts for the door. The second you shut the cash register the customer will stall and immediately return to you and say, "Say, I gave you a ten dollar bill and you only gave me change for a dollar."

If you look a little doubtful or hesitate but a second then the customer will press his claim by saying, "I'm positive I gave you a ten dollar bill and I can identify the bill I gave you because I have a telephone number written on it. I wanted to call a

cab and I looked the number up in the telephone book at the drug store a few minutes ago, and I wrote the cab number on my ten dollar bill."

The customer may even bring out a fountain pen that has an odd colored ink in it, such as green, red, or purple, and will say that the telephone number is written on the ten dollar bill with that same colored ink. If you accept this as proof enough, then you are going to be short changed for nine dollars because you have a ten dollar bill in your register that has the same telephone number on it that the customer says is on it and the number was written on the bill with the same colored ink that is in the customer's fountain pen but—it is the ten dollar bill that was given to you by the first customer who has already left the store.

Naturally, you never suspect that these two customers are working in collusion. If this one is tried on you tell the customer that you can't do anything about the mistake until the register is checked at closing time. You needn't worry about the short changer coming back—they always suspect a trap will be waiting for them.

The "counterfeit bill" short change racket pops up occasionally to victimize quite a few retailers in a short period. A woman will enter your store and will pay for her purchase with a new twenty dollar bill, or sometimes an old twenty dollar. She stalls around for a few minutes so you can get a good look at her.

A few minutes after she leaves your store an elderly man will enter and will call you aside and flash a badge or some other credentials and will identify himself as a Secret Service man. He then shows you a picture of the woman who has just left your store or he describes her and asks you if she could have possibly been in your store during the last three or four days.

The "Secret Service man" acts a little excited and pleased when you identify the woman and tell him that the same woman was in your store but a few minutes ago. He now quickly pulls a slip of paper that has some serial numbers and face plate numbers written on it and he tells you that the woman you identified is a notorious passer of counterfeit money and that she has been flooding your section of the country with counterfeit twenty dollar bills.

He shows you the numbers on the



*Six Months  
from Today*

# Which will YOU hold?

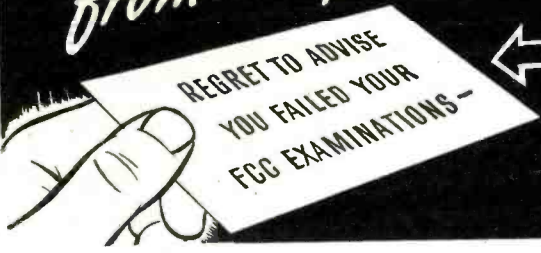

← THIS  
OR THIS →



## WANT YOUR FCC COMMERCIAL LICENSE IN A HURRY?

Use CIRE Training and Coaching Service—and Get Your "Ticket" in a Few Short Weeks!

Thousands of new jobs are opening up—FM, Television, Mobile Communication Systems. These are only a few of the radio fields which require licensed radio technicians and operators.

Get your license without delay. Let Cleveland Institute prepare you to pass FCC license examinations, and hold the jobs which a license entitles you to, with CIRE streamlined, post-war methods of coaching and training.

### Your FCC Ticket Is Recognized in All Radio Fields as Proof of Your Technical Ability

More than ever before an FCC Commercial Operator License is a sure passport to many of the better paying jobs in this New World of Electronics.

Employers frequently give preference to the license holder, even though a license is not required for the job. Hold an FCC "ticket" and the job is yours!

### Hundreds of Satisfied, Successful Students

"I have taken the first class phone license examination and received my first class ticket last Saturday, May 31. In closing I must say yours is an excellent radio course, and I really appreciate your help and the fine service you have rendered me."  
Student #2876N12

"I passed the FCC examination in radiotelephone 2nd class, at Detroit on June 3rd, and I want to thank you for your ready assistance as my instructor on Section I of Nilson's Master Course."  
Student #2799N12

"I have had my 1st class radiotelephone license since March of this year, and plan to continue with your course since I find it a great help in studying transmitters."  
Student #2779N12

"After sending in Lesson E-9 I took the commercial operator's license examination for 2nd class radiotelephone, and passed O.K. I received the license last week."  
Student #2772N1

**FREE BOOKLET**—Tells you the Government requirements for all classes of FCC commercial licenses. (Does not cover Amateur License examinations.) Use coupon below for Booklet B.

## OTHER Cleveland Institute Home Study Courses Offer Complete Technical Radio Training from Low-Level to College-Level, for the Radioman with Practical Experience!

**COURSE A—Master Course in Radio Communication**  
A complete course covering the technical fundamentals of radio-electronics, for the radioman who wants a general review. Includes preparation for Broadcast station employment.

**COURSE C—Specialized Television Engineering**  
An advanced college-level course for the radioman who has had formal training equivalent to A and B.

**COURSE B—Advanced Course in Radio Communication Engineering**  
A genuine college-level radio engineering course, completely mathematical in treatment. For the advanced radioman with considerable practical experience and training.

These three courses in radio-electronics offer a complete, thorough technical training for radioman who wants to cover the field. Available separately or combined.

**FREE CATALOG**—Describes all Cleveland Institute home study courses—tells of CIRE unique, post-war methods of training. Use coupon below for Catalog A.



# HOW TO PASS Commercial Radio Operators' FCC LICENSE EXAMINATIONS...

**CLEVELAND INSTITUTE OF RADIO ELECTRONICS**  
Contractors to the Canadian Broadcasting Corporation CLEVELAND 13, OHIO

**RN-9 TERMINAL TOWER**

Cleveland Institute of Radio Electronics  
RN-9 Terminal Tower, Cleveland 13, Ohio

Gentlemen:  Please send me your Booklet B, "HOW TO PASS THE FCC COMMERCIAL LICENSE EXAMINATIONS," and information about your home study course for preparation for FCC License Examinations. (Does not cover Amateur License Examinations.)

Please send me your Catalog A, describing all of your home study radio-electronics courses.

I desire training in course  A  B  C.

Veterans check for enrollment information under G-1 Bill. NO OBLIGATION—NO SALESMEN.

NAME \_\_\_\_\_

ADDRESS \_\_\_\_\_

CITY \_\_\_\_\_ ZONE \_\_\_\_\_ STATE \_\_\_\_\_

Approved for Training Under "G-1 Bill of Rights"

**Don't Delay—Write Today!**

PACKED WITH *Smooth Power*  
 PRICED FOR POPULARITY

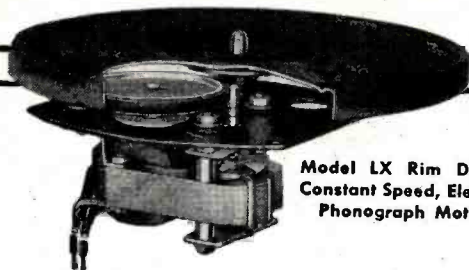

Model LX Rim Drive,  
 Constant Speed, Electric  
 Phonograph Motor

Smooth operation, sturdy dependability and low price of this General Industries Model LX Phonomotor account for its wide acceptance and popularity.

Although compact and lightweight, it has ample power for quick pickup and faithful reproduction of either 10-inch or 12-inch records. Constant speed,

quiet and smooth performance please every customer.

Send for details. Let us help you select the *right* units for your products from the complete GI line of *Smooth Power* Phonomotors, Recorders and Combination Record-Changer Recorders. Prompt deliveries are now available.

Note to individual users: *Smooth Power* motors are sold only through established trade channels.



THE GENERAL  
 INDUSTRIES CO.

DEPT. MR

ELYRIA, OHIO

*Built so You  
 Can Read it!*

**MULTIPLEX**  
 VOLT - OHM - MILLIAMMETER



This is your instrument for all day, every day use. The Multiplex Model 458 is a rugged, accurate, portable, bench-type V.O.M. built to high industrial standards by one of America's pioneer makers of test equipment.

**Multiplex Features:**

Big 5½" d'Arsonval movement meter. 1000 ohms per volt. Multipliers accurate within 1%. Rotary range selector. Copper oxide rectifier for A.C. range accuracy. Priced remarkably low for **\$26.00** NET an instrument of this quality—only.

See Your Jobber or Write for Bulletin 458

**CHICAGO INDUSTRIAL INSTRUMENT CO.**  
 536 West Elm Street - Chicago 10, Illinois

**All Popular Ranges**

- Volts D. C. . . . . 0-5/10/50/100/500/2000
- Volts A. C. . . . . 0-12.5/25/125/250/1250
- Milliamperes D. C. . . . . 0-1/10/100
- Milliamperes A. C. . . . . 0-2.5/25/250
- Ohms Full Scale 1000/200,000/2,000,000
- Ohms Center Scale . . . . . 50/2250/22,500
- Output . . . . . -5 to +55 Decibels

slip and tells you that all twenty dollar bills with these numbers on them are counterfeit, and he acts apprehensive as he asks you if the woman possibly gave you a twenty. He asks you to check up on your twenties in the register to make sure. You look at your twenties in the register and to your dismay you see that the twenty on top in your register has the same serial number and face plate on it.

The "Secret Service man" is pleased at this as he tells you the trail is hot now and that the woman couldn't possibly escape arrest that day because a half dozen men from the department have surrounded that particular locality. He tells you he will have to take the counterfeit bill with him to be used as evidence as he writes out a receipt for you.

He tells you that someone from his department will bring a genuine bill to you for the counterfeit that you turned over to him, and he thanks you for your cooperation as he quickly leaves your store to take up the "chase" for the woman.

The woman wasn't a passer of counterfeit money and the man wasn't a Secret Service man—and the bill that you turned over wasn't counterfeit. The bill was genuine but the man and woman were phonies—just a couple of more short change artists. If this one is tried on you tell the make-believe Secret Service man that you turn over all spurious bills to your banker—and then call the police as soon as he leaves your store.

The "flim-flam" is worked in the following manner: A customer will enter your store and will ask you to give him a five dollar bill for five singles that he has in his hand. If you oblige the customer he will roll the bills in a small wad when you go to your register for the five. When you give the customer the five he tosses his bills on the counter. At this stage a woman will approach you and excitedly ask you the whereabouts or the address of some former employee. The name she gives you is a fictitious one, and she continues to ask questions about this fictitious employee as she confides that she is from the press and that the employee in question is about to be cited for some act of bravery by the president or is about to be given the Congressional Medal of Honor.

While you have mental pictures of heroes floating through your mind and are racking your brains to figure out which of your former employees she could possibly be looking for—you are still straightening out the bills that the man gave you. When you get them straightened out you notice that the man gave you too much money. He had a five and four singles in his wad instead of five singles.

He acts as though he has just realized too that he gave you too much money. Now he fishes another single from his pocket and tosses it to you and says, "Here's another dollar. Just

**NOW AVAILABLE FOR IMMEDIATE SHIPMENT!**

# TELEVISION Values!

## TELEVISION FOUNDATION KIT

The television foundation kit consists of the most essential (and expensive) parts needed in the construction of a television receiver starting with the high voltage power supply, for the picture tube, right through to the antenna. The kit contains the high voltage picture tube transformer (for five or seven inch tube), 2X2 filament transformer, low voltage transformer for the receiver, cathode ray filament transformer, filter choke, 6.3 filament transformer for the 16 six volt tubes along with the five volt transformer for the 5U4. The two high voltage filter condensers, blocking oscillator, transformer all R.F.'s sound and video I.F.'s, peaking coils, discriminator transformer. Rectifier tubes 2X2 and 5U4, the picture tube 5BP4, an all aluminum Elinor dipole antenna are also included. Of course there is the easy-to-follow 26-page instruction book, with a large 12 by 18 schematic diagram. The instructions include television theory, circuit functions, explain scanning, give preliminary voltage measurements, parts layout and final adjustment of the television receiver which facilitates easy alignment without the use of elaborate test equipment. The only knowledge necessary to build this set is the ability to read a simple schematic diagram. Most radio men will have many or all of the minor parts not included in the foundation kit.

**\$34.75**

Remaining set of necessary tubes..... \$16.95

## TRANSVISION TELEVISION KITS

Complete with 7" tube. Thousands of satisfied users. **\$159.50**  
12" Kit Available Soon—Write for Price

## RAY-LECTRON COIL KIT

**INCLUDES:**  
1 Oscillator Tank Coil, 1 Antenna Coil, 6 RF Tuning Coils, all mounted on Switch Assembly Plate; 5 Video IF Coils, Shielded, Permeability Tuned; 1 Shielded Discriminator Coil; 3 Video Tuning Coils; and Instruction Manual containing Peaking Coils and 20 Tube Seven inch Picture Tube Set, together with detailed Assembly Instructions, and Parts list.  
The design of these Coils makes it possible to obtain satisfactory operation within the EN-TIRE service range of ANY Television Station. Complete. **\$23.50**

## NEW TELEVISION COIL KIT 510

Build a 10" or 15" television receiver. Complete kit of permeability tuned video IF, RF, and Sound Coils for high quality television receiver designs. Contains all necessary coils for 3 stages 4mc. wide video, 2 stages sound, discriminator, peaking, oscillator, and RF. Complete instructions included. **\$9.95**  
Priced at Only.....

## NIAGARA COMPONENTS

**CONDENSERS**  
CF 45—.1 mfd—3500 volt DC..... \$ 1.98  
CF 48—.05 mfd—2500 volt DC..... 1.09  
CB 18—.25 mfd—1000 volt DC..... 2.95  
ER25AD—dual 25 mmf per sect. variable condenser..... 2.04

**SOCKETS**  
11 prong isolant scope socket..... \$ .59  
Octal socket..... .12  
Special hi. voltage socket for 2X2..... .59

**TRANSFORMERS**  
TS.6—Scope transformer—2500 v. @ .4 a., 2.5 v. @ 1.75 a., 6.3 v. @ .6 a. \$ 9.95  
TS.5—Western Electric D303184—hi. volt 4200 v. @ 9 ma. lo. volt. 640 v. @ 200 ma.—hi. 6.4 v. @ 5 a., 5.4 v. @ 3 a., 5.1 v. @ 3 a., 2.5 v. @ 1.75 a.—complete television hi. & lo. volt. trans. in one compact oil filled unit—will handle any television tube..... 12.95  
TCH 2—Scope transformer 1750 v. @ 4 ma and matching hi. trans 6.3 v. @ .8 a., 2.5 v. @ 1.75 a., 2.5 v. @ 1.25 a. 1.95  
HF 16—Filter choke 10 hy @ 150 ma..... .59  
LC 2—25 ma R.F. choke..... .59

## MISCELLANEOUS

Pots—all sizes less switch..... \$0.69  
Pots—all sizes with switch..... 1.09  
Trimmers—single 3—30 uf..... .20  
                  dual 5—50 uf..... .35  
13" x 17" x 3" steel chassis cadmium plated..... 1.95  
High voltage wire—50 ft. roll..... 1.00  
Peaking coil..... .45

## NEW, STANDARD BRAND TUBES

TYPE	PRICE	TYPE	PRICE	TYPE	PRICE
1A3	\$0.98	12K7	\$0.89	813	\$5.95
7A7GT	1.10	12SN7GT	.79	814	4.49
1A4G	.90	9520GT	1.25	826	2.25
1L4	1.10	12K8	.99	828	2.25
1R4	1.29	14B6	.99	828B	3.95
1T4	1.10	30	.78	830B	5.25
1M5	.99	34	.98	832	3.95
1N5GT	1.10	35Z3	.99	832A	3.95
1LNS	1.90	35L6	.99	835	3.00
1S5	1.10	32L7	1.50	837	3.75
30A	1.10	35W4	.89	838	3.00
30SGT	1.10	37	.69	860	4.95
6AB7/1853	.99	38	.89	7193	4.95
6AC7	.99	39/44	.89	8011	1.25
6AD5	.99	41	.64	824	1.95
6AG7	.99	45	.89	824	1.95
6AK5	.99	47	.90	4C 35	4.95
6AL5	.99	50B5	1.59	5R4Q3	1.75
6AT5	.98	5085	.89	5U4	.98
6BA	1.29	70L7	1.59	5U4	.98
6BG6	.89	71A	1.69	5W4	.99
6C4	.64	71A	1.69	5W4	.99
6CS	1.10	75	.75	5Y4G	.59
6C6	.75	955	.75	5Z3	.89
6D6	.75	957	.75	2526	.99
6E5	.81	958A	.75	3574	.99
6F7	1.25	958A	.75	3574	.99
6F8	1.10	9001	1.15	80	.75
6G6	1.10	100T5	.98	82	.75
6H6	.59	9002	.98	82	.75
6HG6T	.89	9003	.98	83	.75
6J5	1.59	9004	.98	84	.98
6J6	.89	9005	.98	84	.98
6J7	.89	4E08	.89	217C	7.50
6K6	.89	10Y	1.50	250R	3.95
6K7	.89	15E	1.50	836	1.50
6L6	1.29	HF100	.89	856A	.75
6L7	1.25	HY615	.89	872A	2.25
6L8	1.25	V70D	.60	884	.75
6L9	1.20	713A	1.65	5V3	.90
6N7	1.25	2C26A	.75	2051	.60
6R7	.98	2C34	1.15	8K80	1.25
6S7	.85	2J32	20.00	VR78	.75
6SC7	.85	2J32	20.00	VR90	.75
6SF5	.79	811	1.25	VR158	.75
6SH7	.89	2J56	20.00	2225	1.95
6SK7	.79	3E29	2.95	1613	.95
6SL7	.89	3047M	9.85	1618	2.95
6SN7GT	.89	3047M	9.85	1618	2.95
6SQ7	.89	4A6A	2.80	1624	.98
6SR7	.89	6C4	.64	1625	.98
6SS7	.75	6C4	.64	1625	.98
6QS	.98	705A	22.50	17A	1.95
6R5	.98	803	2.25	3AP1	2.25
6US	.98	800	2.25	3AP1	2.25
6V6GT	.99	801A	6.95	3BP1	3.95
6V8	1.50	805	3.75	5BP4	5.45
7C4	1.25	807	2.95	5CP1	3.95
7F7	1.39	809	1.50	797	7.95
12AT7	1.10	811	1.95	913	3.00
12SA7GT	.99	824H	6.90	7EP4	23.50

**NO MAIL ORDERS FOR LESS THAN \$5.00.**  
All Tubes are guaranteed with exception of open filament, which are checked before they leave our warehouse. All tubes shipped via Rail Express.

## SELSYN MOTORS—Synchronous Type

Pair in Series for 110 v. AC.  
Type I—5 1/2" long, 3/4" dia.—50 v. AC. 50  
Type II—6 1/2" long, 1 1/4" dia.—115 v. AC. 12.95 pr.  
Type III—2 3/4" long, 2 1/2" dia.—50 v. AC. 8.95 pr.

## JOHNSON EDGEWOOD COILS

No. 2263HM4  
Just the thing for your antenna tuner. Heavy duty Hi-volt insul. coil—ruggedly built—handles up to 750 watts R.F.—Turns can be removed to resonate at any amateur band. Heavy mycalex insulation, air winding. Efficiently made to give lower surface resistance by flat winding. 26 turns spread 1/4" apart. Complete with two 4" mounting lugs..... Excellent buy, 2 for **\$3.95**

## DYNAMOTOR

12 v. dynamotor—ideal for portable 2 meter rig—low battery drain. 235 v. output at 90 mls. Can be run at 50% overload—gives up to 110 mls at 215 v. without damage for continuous duty—complete with filter..... **\$4.95**

Micro Switch—can be used on AC with ratings of 1200 watts up to 600 v. AC also for DC work—normally open. Die Cast..... **\$1.25**  
BZE-2RQ9TN.....

Blower 6 v. AC or DC hi speed blower made by John Oster. Rated at 5000 RPM—1 1/2 AMP—made for continuous duty—1 1/2" overall diameter—1" blower output—1/4" blower intake..... **\$5.95**

## AMPHENOL COAX CONNECTORS

83-15PN..... \$0.45  
83-1R..... .45  
UG-12/U..... 1.49  
83-1T..... .79  
83-1AP..... 1.49  
UG-28U..... .99  
83-1F..... .99  
Birnback No. 1475 feed thru insulator..... \$0.29

Rotary Switch—3 deck—9 position non-shorting ceramic wafers. Each..... **\$1.25**

CF27—Filter Condensers—1 MFD 2500V, DC..... **\$1.19**

R.F. Choke—R154—1MH @ 600 MA with mounting bracket..... **\$1.25**

R.F. Choke—312 MH @ 150 MA on ceramic with threaded mounting hole..... **.18**



## FULL WAVE SELENIUM RECTIFIER

Perfect for bias application—Use your DC relay from an AC source. Full wave selenium space Rectifier for input up to 300V @ 40 ma out-put. **\$.89 or 5 for \$4.00**

## ROTARY ANTENNA DEVICE

Here is the answer to that rotary antenna joint problem for 360°. A compact unit with four slip rings & contacts, silver plated, of course. Can be used for a stacked array—10 & 20, 6 & 10, 2 & 6, etc..... **\$1.89**



## CARBON THROAT MICROPHONE

This microphone will work into any 200 ohm impedance input circuit. Has adjustable strap to fit any neck. In operation this microphone is strapped around the throat thereby facilitating full freedom of both hands and head movement. Ideal for ultra high frequency mobile work for hams. Supplied with strap, 10' cord and plug. **.49**  
Your Cost.....

300 ohm twinex—unaffected by moisture—will handle 3 kilowatts of R.F.—losses at 40 MC per 100 ft., are 3/10 DB. Best buy in the house at .08 per foot.

## SOCKETS

- KS-3—Amphenol—octal type, ceramic, chassis type elastic stop nuts..... \$0.12
- KS-5—Isolantite—5 prong, ceramic, large chassis type..... .12
- KS-6—Isolantite—6 prong, ceramic, large chassis type..... .12
- KS-7—Johnson—1 prong ux base, bayonet, ceramic 25 watt..... .75
- KS-8—Hammarlund—S7—isolantite, with hardware..... .19
- KS-14—Chassis type octal mica filled bakelite, for 6 volt tubes..... .29
- KS-16—UHF octal steatite for 6F4, 955 etc. (metal shield with spring—10 cents extra)..... .09
- KS-17—Johnson—5 prong socket for RK-28, 803 ceramic, bayonet..... 1.49
- KS-20—Johnson—ceramic for 304TH, 304TL..... 1.00
- KS-21—7 prong for RCA 813, mykroy, 2 3/4" square..... .69
- KS-22—Magnal—14 prong scope socket, mica filled low-loss bakelite..... 1.00
- KS-24—Ucinite 829, 832 socket, recessed aluminum case for sub chassis mounting. Socket has built in by-pass condensers..... 1.75
- KS-25—Johnson—7 prong for 829, 832 tubes, ceramic..... .29
- KS-27—Mykroy socket for VT127/100TS..... 1.25
- KS-28—7 prong miniature with shield..... .39

OTHER TYPES IN STOCK—PRICES ON REQUEST

Weston meters—0-130 V. AC—25 to 125 cy—\$3.95  
#476UM—3/2"

## DO YOU OWN AN SCR-522?

We have a complete power supply, including a separate voltage regulated bias supply chassis and schematic—all in kit form. This kit will supply all voltage necessary for normal operation of the set. All parts guaranteed. Complete at the amazingly low price of..... **\$14.95**

## BC-348 Owners

## CONVERTER FOR BROADCAST BAND

Convert that BC-348 without any alteration in your circuit. Our special converter takes power from receiver. Just tune your set to 455 kc. and forget it. All tuning is done on a converter panel covering 550 to 1600 kc.—double conversion means High Sensitivity, Excellent Fidelity, and Higher Selectivity—complete basic kit with schematic and full instructions—less chassis dial and tuning knobs. **\$6.50**  
Terrific Buy at.....

## POWER SUPPLY KIT FOR AC Conversion

Complete—Contains all necessary components for 110 v. 60 cy. conversion of BC-348. **\$7.50**  
A Not Special.....

## HS-16 HEADSET

- 8000 ohms Hi-impedance
- Noise proof
- Most sensitive phone built
- May be used as a sound powered intercom

Light, durable, efficient. Molded neoprene earcups, padded to completely envelop entire ear. Adjustable steel headband extends & retracts. Especially suited to hams, commercial operators, aircraft pilots, recording engineers and many others.

Can be used with simple Xtal to make complete radio receiver. **\$1.89**

Special..... Original cost \$25.00. **\$0.49**  
6 foot extension cord.....

20% Deposit on all orders unless rated. We prepay freight on \$100.00 orders in U.S.A.

# NIAGARA RADIO SUPPLY CORP.

160 Greenwich St. New York City 6, N. Y.

Write for latest Bulletin 9 RN. All prices F.O.B. New York City.

# Faster Easier Servicing



PRECISION  ELECTRONICS

## SIGNAL TRACER WITH V.T.V. METER

- Electronic Vacuum Tube Volt Meter (4 stage)
- Highest gain unit on the market (gain 12000).
- Lowest input capacity 3mmf (no detuning effects).
- Small, easy to handle Probe, 7" x 7/8" dia.
- AC operated 105-120 V. 50-60 cycle (no batteries).
- Probe tip made of Polystyrene, with aluminum barrel.
- Audio input—quality amplifier—checks pickups, microphones, etc.
- Frequency range from 20 cycles to 300 M.C.
- For intermittents and faders, gives complete over-all picture.
- Only real means of checking noise in vacuum tube, in the set.
- Locates motor-boating and squeals.
- Isolated from AC line, may be used on AC or DC sets.
- The ONLY Signal Tracer to meet all requirements for performance and quality of parts.

Only  
**\$44.95**  
NET

SEND FOR FREE CATALOG OF RADIO SUPPLIES

**THE RADOLEK COMPANY**  
601 W. RANDOLPH STREET  
Dept. B230  
CHICAGO 6, ILL.

IN STOCK  
ORDER  
TODAY  
STOCK NO. 17111

## CUT HOLES 1/2" to 3 1/2" IN RADIO CHASSIS



WITH A GREENLEE  
RADIO CHASSIS PUNCH

• Save hours of work . . . no reaming or tedious filing. Punch cuts through chassis quickly . . . makes accurate, clean holes for sockets, plugs, and other receptacles. Just turn with an ordinary wrench. There's a GREENLEE Punch in each of these sizes: 1/2"; 3/8"; 3/4"; 7/8"; 1"; 1 1/8"; 1 1/4"; 1 3/8"; 1 1/2"; 1 3/4"; 1 7/8"; 1 3/2"; 2 1/4". Write for complete facts. Also get information on Knockout Punches and Cutters for conduit and meter holes up to 3 1/2". Greenlee Tool Co., 1889 Columbia Avenue, Rockford, Illinois.

TOOLS FOR CRAFTSMEN  
**GREENLEE**  

## "America's Best Buy"

### TUBULAR ELECTROLYTICS

Fresh Stock. Fully Guaranteed

	Each	10	100
20 mfd. . . . . 150V	\$0.21	\$1.79	\$16.95
20-20 mfd. . . . . 150V	.29	2.49	22.98
8 mfd. . . . . 450V	.19	1.85	17.98

### BY-PASS CONDENSERS

.01 . . . . . 600V	\$0.06	\$0.55	\$ 4.60
.02 . . . . . 600V	.06	.55	4.75
.05 . . . . . 600V	.06	.55	4.95
.1 . . . . . 600V	.07	.65	5.49
.25 . . . . . 600V	.11	.98	8.95
.005 . . . . . 1700V	.14	1.25	9.95
.01 . . . . . 1700V	.15	1.30	10.20
.02 . . . . . 1700V	.16	1.40	10.95

### RESISTOR ASSORTMENT

100 assorted 1/4-1/2 watt carbon resistors.  
All RMA color coded. Special \$1.29.

### CRYSTALS 74c each

Your frequency plus or minus 10 KC



80 Meter, 3500-4000KC
40 Meter, 7000-7300KC for multiplying into
20 Meter, 7300-7425KC
10 Meter, 7300-7425KC
6 Meter, 6250-6750KC
2 1/2 Meter, 8000-8222KC

Postage extra. 20% deposit on COD.  
Write for latest bargain list featuring

"America's Best Buys."

**POTTER RADIO CO.**  
1314 McGee St., Kansas City 6, Mo.

put it with my other nine and give me a ten spot for my ten dollars while you're at it." Since he actually does give you nine dollars the first time and another dollar a minute later—ten dollars in all, you can easily see why you can be short changed on this one. Naturally, with the short changer's woman companion keeping up a continuous line of chatter and questioning you without pause in an effort to confuse you and keep your mind off the money transaction, you can understand and sympathize with the retailers who get short changed this way.

The "important letter" short change racket is often worked by women. A woman will enter your store and anxiously ask you if you would please give her a ten dollar bill for the ten dollars in change she has in her hand. She shows you a stamped, addressed, special delivery letter and tells you that she has to send the ten dollar bill in the special delivery letter immediately to a son or daughter, who is stranded in a nearby city without funds, or to a sick or injured mother or father, etc.

She always gives you a plausible excuse for wanting the ten dollar bill, and since it will cost you nothing to oblige the woman you will head for your register to get a ten for her. She starts to count her change when you go to your register. She counts it from one pile to another and keeps her hand on the pile she is counting to prevent you from counting the money before she finishes. She finishes her count and calls out, "And ten dollars even!"

You either hand the woman the ten dollar bill or place the bill on the counter for her. Of course you are going to count the change again. While you are counting the change the woman picks up the bill and calls your attention to it when she places the bill in her special delivery letter. After she has made sure that you saw her place the bill in the letter she takes a folded newspaper from under her arm and places it on the counter. She attracts your attention again as she wets the gummed flap of the letter. She then quickly places the letter between the folds of the newspaper and presses across the paper a few times to seal the letter tightly.

She now takes a special delivery letter from the folds of the paper and places it on the counter near you as you continue to count the change. When you finish counting the change you discover a twenty-five or fifty cent shortage. The woman says she is almost sure that she had the correct amount of change and asks for the change so she can count it again.

She quickly counts the change and this time she counts it from the counter to her hand. When she finishes counting she has all the change in her hand and she agrees with you that there is a shortage. Now she acts as though she has just realized that the bill is already sealed in her special

**RADIO NEWS**

# WHAT SERVICEMAN COULDN'T MAKE MORE MONEY THIS WAY?

The business-like way to make money is to keep plugging ahead at your bench. If your stock is lean and you have to run to the distributor every time you need a volume control, you're frittering away your valuable "bench time" and income. Stock up too high on "special" volume controls and you may wind up behind an inventory 8-ball.

## HERE'S THE RIGHT ANSWER 9 OUT OF 10 TIMES

The sensible solution to your volume control replacements is the IRC *Century Line*. Over 90% (by actual analysis) of all jobs can be taken care of by these 112 types of volume controls. As a matter of fact, you don't even need the entire 112; a selection of only 70 Type D IRC Volume Controls and 11 Tap-In Shafts may handle most of your work. So see your IRC Distributor right away and save your bench time, patience, and money with IRC.

### THE IRC CENTURY LINE

The 112 Volume Controls and 5 Switches That Solve Over 90% of Your Replacement Problems . . . . .

- 70 Universal Type D Controls with 11 easily installed Tap-in Shafts
- 16 Popular Type Controls with Fixed Shafts
- 8 Clutch Type Controls with Fixed Shafts
- 7 Dual Controls with Fixed Shafts
- 9 Controls for Specific Service Used with Fixed Shafts
- 2 Special Controls for Power Requirements with Tap-in Shafts
- 5 Switches



Bring yourself up to date with the new No. 4 Edition of this amazingly popular and useful manual. Contains detailed replacement information on nearly all models up to 1946. Complete listing of 1941-42 models . . . the ones now coming in for repair. 156 pages. 25c at your IRC Distributor.

**INTERNATIONAL RESISTANCE COMPANY**

401 N. BROAD STREET PHILADELPHIA 8, PA.

Wherever the Circuit says 

In Canada: International Resistance Co., Ltd., Toronto, Licensee

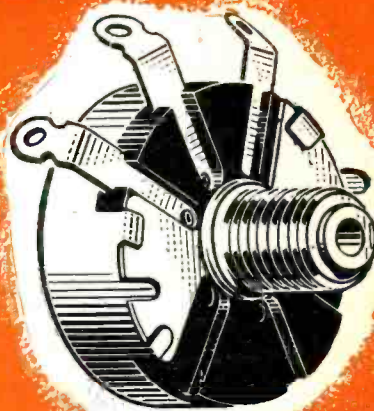

ONE OF THE 70 BASIC  
TYPE D IRC VOLUME  
CONTROLS



NOW THE CONVENIENCE OF 11 IRC TAP-IN SHAFTS  
— FOR ALMOST EVERY REPLACEMENT NEED.

# 30,000 SERVICEMEN READ

DEVOTED ENTIRELY TO THE 25 CENTS  
**RADIO SERVICEMAN**

**RADIO MAINTENANCE**

AM - FM - TELEVISION  
SOUND EQUIPMENT  
RECORD CHANGERS  
ELECTRONIC DEVICES  
TESTING  
ALIGNING  
TRACING

A BOLAND AND BOYCE PUBLICATION

## EVERY MONTH

RADIO MAINTENANCE today fills a breach that has existed in the radio field for a long time. Already 30,000 servicemen read RADIO MAINTENANCE every month because it is devoted entirely to the radio serviceman.

The RADIO MAINTENANCE staff specializes in the preparation of articles on every phase of Radio Maintenance in series form which may be filed and used for reference. The leading articles cover everything for the radio serviceman on Television, FM and AM; Test Equipment; Electronic Appliances; Tools; Antennas; Alignment; Troubleshooting; Repair; Construction; Pick-Ups and Sound Amplification and Reproduction Equipment. Also, in RADIO MAINTENANCE each month there are departments on hints and kinks, the latest news of the trade, review of trade literature, radiomen's opinions, new products and news from the organizations. All articles are presented in a step-by-step precision style, clearly illustrated, with schematics, accurate photographs, specially prepared drawings, white on black plots, color diagrams, isometric projections and exploded views.

Tear off coupon below and mail today.

Your first issue will be mailed immediately on receipt of this coupon. One issue FREE if payment is enclosed.

Same  
day  
Service

RADIO MAINTENANCE  
MAGAZINE  
460 Bloomfield Avenue,  
Montclair 3, N. J.

Please send me RADIO MAINTENANCE every month for

- 1 year at \$2.50       Payment enclosed  
 2 years at \$4.00       Bill me later

Name.....

Address.....

City—State.....

\* Occupation.....

Title.....

Employed by.....

\* Independent Serviceman—Dealer Serviceman—Service Manager—Dealer—Distributor—Jobber.

**BOLAND & BOYCE INC., PUBLISHERS**

delivery letter and also that she doesn't have another penny change with her.

She says she is so worried about her injured relative or stranded child that she hardly knows what she is doing. The important letter is on the counter near you and she picks it up and says to you, "Must I tear open my letter and get your ten dollar bill out, or would you please put my letter in a safe place for me while I run down the street a few squares to my home and get you the few nickels I'm short?"

Ninety-nine out of a hundred dealers will agree to put the letter in their cash register for safe keeping for the woman while she runs down to her home for the needed change. When the woman leaves she has the ten dollars in change in her hand. And, sad to relate, she will never return for her letter. You may think you are not taking any chances when the woman leaves the letter with you because you actually saw her place the bill in the letter and seal it shut before your eyes and therefore aren't taking any chances, but you will be doomed and disappointed when the woman fails to return for her letter because the letter you have in your

register is a duplicate letter that she had concealed in the folds of her paper. When she wet the gummed flap of the first letter and put it in the paper to seal it she switched letters and took the duplicate letter from the next fold of the paper and placed it on the counter for you.

The "Quarter Switch" is one of the cheap short change rackets and is worked in the following manner. The short changer always keeps a nickel concealed between his fingers and switches it for one of the quarters that have been given to him as change. He quickly steps away from the change and points at it as he calls your attention to it. He laughingly suggests that a nickel probably got mixed in the quarter compartment of your register, thereby causing the mistake. Since the amount is so small and the customer's explanation a plausible one you usually give the worker of this racket the additional twenty cents. One short changer arrested for working this racket admitted that he had worked it thousands of times on unsuspecting merchants. He had worked it on seventeen merchants the day he was arrested. So, you see a short change racket can be worked on you if you're not on your toes.

-30-

## NEW TYPE FM TUNER UNIT

THE development of a new and different FM tuner unit has recently been revealed to the trade.

The system from the mixer through the 10.7 mc. i.f. circuit is of conventional design, but the front end assembly features a completely new tuning system. It consists of a modified form of long lines, using an L-C combination in series to cover the 88 to 108 mc. range. The line tuners are semicircular brass rod assemblies with .0005 inch silver overlay, and with the use of

offer relatively negligible initial drift.

The co-engineers, Mr. Burley and Mr. Cossman of Approved Electronics Instrument Corporation of New York are now planning amateur equipment based on this same principle.

They have already had test setups working on the two-meter band and the 144-148 mc. spectrum was spread over more than 2 inches of the 16 to 1 ratio dial.

Production on the FM tuner started in July.

-30-

Manufacturer claims 200,000 revolutions of the slider without contact trouble.

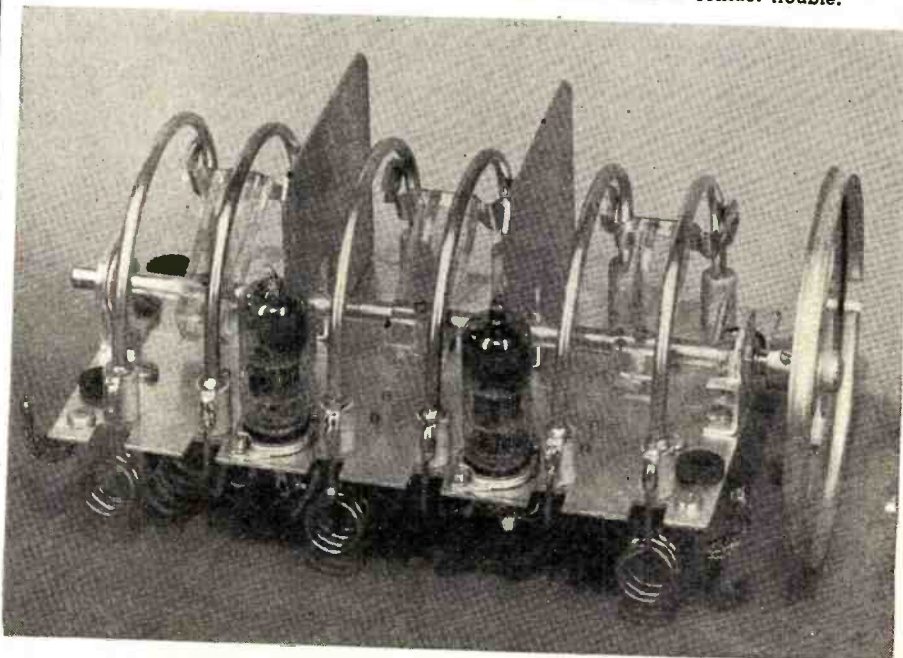

## HIGH VOLTAGE COMPONENTS

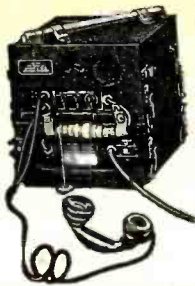

SCR-610 low power FM trans-rec. Battery operation on 27mc to 38.9 mc. Less crystals. \$39.50

**2.6 KVA Amertran Rectifier**—output: 0 to 25 KV. at 1A 10% regulation, 2.5% Ripple Input: 208 V, 3 PH., 60 to 60 C.

**FIL. TRANSFORMER** 29,000 V. test. Pri. 115 v. Two Sec. 5 v. at 5 amp. Raytheon. \$16.50

**2 KVA Transformer and choke**—115v/50 to 70c input, single phase. Output 17,000v at 144 mils. Amertran. Dimensions: 26x29x13. \$74.50

Capacitor—continuous phase shift; effective range 100 cy to 800 kc. \$1.95

Condenser—butterfly, 13 plate, 1 1/2 x 1 1/2", ball bearing. .95

WE 1-138 Sig. Gen. 2700-2950 mc. CW provision for pulse modulation, 115-VAC regulated power supply, output meter, attenuator. \$50.00

## HEADSETS

**New insert type**—comfortable, lightweight, efficient. 500 ohms impedance. \$0.85

Output trans. to match 500-8000 ohms imp. .25 extra.

**Headgear Dynamic mike and headset combination**, sound powered. From B-10. Mike and earphones complete. \$2.75

**Lapp Bowl Type entrance insulator** 7" diam. 4.5" high, 9/16" hole. \$1.48

## TUNING UNITS

From BC191 and 375

—contains: coils, chokes, dials, condensers. Range of frequency from 400 KC to 12.5MC. State your approximate frequency. Only \$2.75

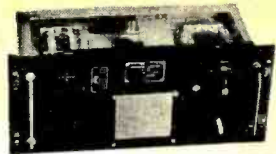

### Ideal Basis For E.C.O. Rig

Tuning units for TCE & GP7 in the following frequencies: A—350 to 800 kes; B—800 to 1500 kes; C—1500 to 3000 kes; E—4525 to 6500 kes; F—6200 to 9050 kes. Contains all coils, etc. for these frequencies. Complete set of five \$11.00

Units C, F, Each \$2.75

Units A, B, E, Each \$2.00

## DEPENDABLE EQUIPMENT

# "Communications"

REASONABLE PRICES

MFRS  
WIRE  
FOR  
QUANTITY  
PRICES

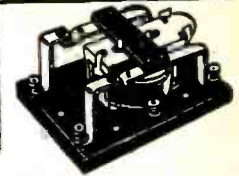

**Remote Control Unit RM-29.** Ideal for telephone inter-communication over distances up to several miles. Includes ringer. Two units complete with handsets for 2-way communication. \$14.00  
RM-29, each \$5.50  
Handsets, each \$2.00

**OIL CONDENSERS**  
Sprague, Aerovox, Cornell-Dubilier  
15mf 220 vac, 600 vdc CD. \$ 1.75  
1 mf 300 vdc. .20  
2 mf 300 vdc. .25  
4 mf 300 vdc. .30  
4 mf 400 vdc. .50  
5-5 mf 400 vdc. 1.05  
1 mf 500 vdc GE. .25  
2 mf 550 vdc. .25  
25 mf 600 vdc. .20  
85 mf 600 vdc. .25  
1 mf 600 vdc. .30  
1-1 mf 7000 vdc G.E. Pyr. 2.00  
In lots of 50. 1.50  
2 mf 600 vdc. .35  
6 sect. ceramic stack variable 35-460 mmf 500v. 1.79  
1 & 5 mf 2000 vdc. 1.25  
10 mf 600 vdc. .85  
5-5 mf 600 vdc Tobe. 1.00  
5-2.5-2.5 mf 600 vdc. .75  
8-8-4 mf 650 vdc Sprague. 1.45  
7 mf 800 vdc. .90  
3.5-5 mf 1000 vdc. 1.00  
4-1.5 mf 1000 vdc. 1.00  
5 mf 1000 vdc G.E. .55  
1 mf 1000 vdc. .75  
1 mf 1000 vdc. .25  
2 mf 1000 vdc. .89  
10 mf 1000 vdc. 1.40  
1 mf 1500 vdc. .95  
4 mf 1500 vdc. .15  
2 mf 660 ac/1000. .85  
1-1 mf 2000 vdc. 1.00  
1 mf 2000 vdc. 1.00  
1 mf 3000 vdc. 3.50  
1 mf 7500 vdc. 12.50  
25 mf 20,000 vdc. 17.50  
1 mfd 6000 vdc G.E. 1.05  
1.5 mf 6000 vdc. 12.50  
4 mf, Solar, 50 WVDC. .49

**Mica**  
.002 mf 15,000v Sangamo. 20.00  
.002 mf 6000v. 8.50  
.005 mf 15000v. 22.00  
.006 mf 10000v. 17.50  
**Electrolytics**  
2 mf 1000 vdc Sprague. .50  
2 mf 600 vdc CD. .40  
10-10-10 mf 90 vac. 1.95  
200 mfd 250v. 2.00  
4000 mfd 30v CD. 2.50

**Dynamotors**  
For that Emergency Rig  
DM-21: In 14VDC 3.3A Out 235VDC 90 ma with filter. \$2.59  
DM-25: In 12VDC 2.3A Out 250VDC 50ma. \$2.49  
DM-34: In 14VDC 2.8A Out 220VDC 80ma. \$2.49  
DM-42: In 14VDC, Out 515/1030 VDC 215/260ma & 2/8VDC \$3.95

**Hand Generators**  
GN-45 Plate & fil supply. Output 500VDC 140 ma and 6V 3A. Dim. 8"x8"x6". \$4.95  
GN-35 2.5 amp at 8V, 100 ma at 325 to 365V; or 1.25 amp at 10V, 70 to 880 to 420V. \$3.50

## MICROWAVE PLUMBING

### 1.25 CENTIMETER

Wave Guide Section 1" cover to cover. \$ 2.00  
T section choke to cover. 4.50  
Mitred Elbow cover to cover. 3.00  
Mitred Elbow and "S" sections choke to cover. 3.50  
Flexible Section 1" long choke to choke. 3.00  
Tunable Cavity with Coax input and output. 6.00

### 3 CENTIMETER

T Sections. \$ 5.50  
Wave Guide Sections 2.5" long silver plated with choke flange. 5.75  
Wave Guide 90 deg. bend E plane 18" long. 4.00  
Wave Guide 90 deg. bend E plane with 20DB directional coupler. 4.75  
Wave Guide 18" long "S" curve. 2.00  
Feedback Dipple Antenna, choke input. (used with parabola). 4.50  
Rotary joint wave guide in/out choke to choke joint. 6.00  
Rotary Coupler choke input: round guide output. 5.25  
S curve Wave Guide 8" long cover to choke flange. 5.95  
Wave Guide 2.5" long, silver plate, 180 deg. bend choke to cover. 10.00  
Duplexer section using 1B24. 4.00  
Wave Guide with slotted section and rotary joint. 1.50  
Wave Guide 5" length per foot. 1.50  
Pick-up loop with adjustable tuning section, used in duplexer. 1.50

### 10 CENTIMETER

Sand Load (Dummy Antenna) wave guide section with cooling fins app 23" high. \$28.00  
Wave Guide to coax with flange, gold plated app. 10" high. 17.50  
Rigid Coax Directional Coupler CU-90/UP 20 DB drop, has short right angle, about 8". 5.50  
Standing Wave Detector rigid coax 58 ohms Coax Rotary Joint with mounting plate. 5.50  
Antenna in lucite ball for use with parabola. 8.00  
Flexible Coaxial Connector, rigid coax to rigid coax 3/8" diam. 5.00  
Flexible Coaxial Connector, rigid coax to rigid coax 1/2" diam. 2.50

**SPECIAL**  
Maguire Wavemeter—No. 1539TFX, 3cm, vernier dial and resonant cavity. \$20.00

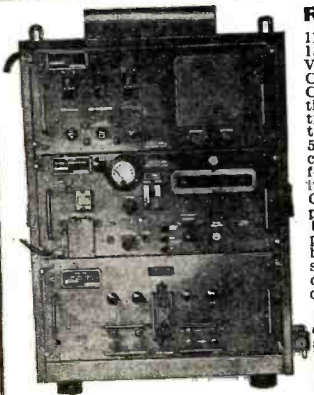

**RC-145, NEW,** complete with instruction book, including set-up, rotary beam direction indicator unit. \$200.00  
**RC-148,** consists only of transceiver and power supply. Both units with tubes. Slightly used. \$47.50

## Relay Miniatures

SPDT 24VDC. \$ .40  
SPST 28VDC. .40  
DPDT 28VDC. .45  
SPST 100V overload 380/1800cy. .40  
SPDT 110VAC 380/1800cy. .40  
Discount on Lots

## Telephone Relays

SPDT—with cover. 1.05  
DPST. 1.05

## Miscellaneous Types

SPDT 5VDC in can with 5 pr. base. .85  
DPDT 6VAC Struthers-Dunn 1.45  
DPST 6VAC Struthers-Dunn. 1.35  
2 Section SPDT 6 VAC Wheelock type. 1.10  
SPDT 115 VAC Leach. 1.00

## SPICIALS

**RG-9U Coax,** GE, silver coated copper, 51 ohm surge impedance. Sold in 100 ft. lengths and 500 ft. reels. Per ft. \$0.07 1/2  
**Rectifier transformer**—117VAC input; output 62V at 3.5A. AC. Rectify and use with filter and rheostat to run your 6, 12, and 24VDC equipment. \$1.50  
**Capacitor**—continuous phase shift; effective range 100 cy to 800 kc. \$1.95  
**Vibrator Transformer**—Primary: 6, 12 and 24V; secondaries: (2) 120V @ 175ma, (1) 11V. Dimensions: 3.25"x3"x3"  
**Selsyns**—Type 5G 115V, 60CAC Dim: 3 3/4"x5 1/2". Special: a pair. \$7.75  
**Toggle sw**—4PDT, bat handle. \$0.69  
**Power Pair**—Transformer 470V CT @ 60ma; two 6.3V windings @ 1.65A and two 5V @ 2A.—Primary: 115V 50 to 1200 Cy. PLUS a 6 Hy, 50 ma choke. Both. \$1.99  
**Tunable Packaged Magnetrons**  
each with calibrated tuning chart  
QK59 2675-2900 mc  
QK60 2800-3025 mc  
QK61 2975-3200 mc  
QK62 3150-3375 mc  
Set of 4. \$160.00  
Each. 45.00

## SPDT 115 VAC, WE Wheelock type. \$1.25

SPDT 115 VAC, Kurman latch type. 2.49  
SPDT 115VAC GE, with SPST thermal delay section. 1.95  
DPDT 24VDC Allied. .75  
DPST Leach antenna relay with SPST revr section 24 VDC & 12VDC. 1.25  
4PDT 24VDC GM. .85  
Solenoid contactor 24VDC Leach. 1.05  
Thermal delay, 45 to 60 sec. Edison type 1503 with 4 prong base. 2.95

## 6 VDC Relay Panel

3-DPST; 2-SPST 6 vdc relays mtd on 10"x7" panel. 2.75

## Microwave Tubes MAGNETRONS

3J31 1cm. \$17.50  
2J26 10cm. 25.00  
2J32 10cm. 25.00  
2J38 10cm with magnet. 37.50  
WE 700A L Band. 35.00  
WE 720BY S band with magnet. 20.00  
38.50  
**KLYSTRONS**  
2K25/723ab. 7.75  
2C40 Lighthouse tube. 2.50

## ARC-5 Receiver Accessories

Triple head control box. \$1.00  
Plug-in coil unit 19-.52 mc or .52-1.5 mc ea. .50  
Mounting rack. 1.00  
Double mounting rack. 1.65  
Shock mounts. .95  
All parts interchangeable with SCR-274-N.

## RCA 12 Tube Superhet

100 to 1500KC, 115V operation Dim: 24"x18"x13". Used in excellent condition guaranteed. \$29.95

## TRANSFORMERS

All Primaries 117V 60 cy Secondaries  
No. 5084—1000V CT and 280V CT @ 250ma, 6.3V @ 15A. \$ 6.95  
No. 6114—1900 V CT @ 350 MA by using 2 trans. Per. Pr. 10.00  
No. 5190—6180V @ 200 ma. 2.75  
No. 5057—6.3 CT 1A, 5V CT 3A, 5V CT 3A. 2.45  
No. 5104—6.3V @ 1A, 6.3V @ 1A, 6.3V @ 1A. 2.25  
No. 5126—5V CT 3A, 5V CT 3A, 5V CT 6A. 2.45

## CHOKES

Amertran—RMS test 15KV, 1 Hy. 8 amp DC, DC resistance 7.5 ohms. \$8.85  
8.5 Hy. 125ma, 1780 V Test. 1.95  
Dual: 7Hy. 75ma, 11Hy. 60 ma, 1780V test. .90  
Dual: 2hy 100 ma each section. Utah. .45  
Filter choke. CTC. 5hy 40 ma. (Conservative Ratings)

## PULSE TRANSFORMERS

GE Type K2450A. Will receive 13KV, 4 microsecond pulse on prim-secondary delivers 14 KV. Peak power out 100KW. \$15.00  
Hi Volt. Magnetron input transformer. W.E. No. D-166173 with cooling fins. 12.60  
Raytheon UX 4298E—Pri. 4 KV, 1 microsecond Sec. 16 KV. 16 Amps. Fil. pri. 115V. 400 Cycle. 15.00  
W.E. Hi Volt input pulse transformer No. D 169271. 9.95  
GE Radar pulse Transformer K2731 Diameter App. 11" vertical cooling fins. 19.50  
Utah Blocking Oscillator transformer, 3 windings. No. 9280 or 9318. ea. 7.75  
Pulse Input line to magnetron GE K2748A. 12.00

## THERMISTORS

D167332 bead. \$0.95  
D170396 bead. .95  
D168391 button. .95  
D167613 button. .95

ALL MERCHANDISE GUARANTEED. Mail orders promptly filled. All prices F.O.B., N.Y.C. Send Money Order or Check. Rated Firms send P.O. Shipping charges only sent C.O.D.

# COMMUNICATIONS EQUIPMENT CO.

131-N LIBERTY ST., WH 4-7658, NEW YORK CITY 7, N. Y.

**Are You Missing  
The Best Values  
In Radio?  
SEND FOR THIS NEW  
FREE  
CATALOG NOW!**

Here's the handiest, most complete radio buying guide in America. Contains over 10,000 items of nationally known quality. Brings to your door step the world's largest and most complete stocks of radio and electronic equipment. *Save time, work and money—send for your free copy.*



**MAIL COUPON  
BELOW FOR  
144  
VALUE-PACKED  
PAGES**

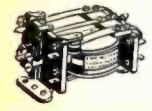

**PARTS.** America's biggest stock of quality parts and equipment. Everything for hams, soundmen, engineers, servicemen, experimenters. All leading makes at economy prices.



**RADIO SETS.** The new Lafayette Catalog is a regular parade of all the latest 1947 models, including phonoradios, portables, communication receivers. Latest styling—outstanding performance—wonderful values.



**P.A.** Sound systems for every type of public address installation. Complete listing of amplifiers, microphones, speakers, accessories. Many new developments listed for the first time.

**Lafayette Radio**  
RADIO WIRE TELEVISION, INC.  
100 Sixth Ave. • N. Y. 13  
110 Federal St. • Boston 10  
24 Central Ave. • Newark 2, N.J.

Paste Coupon on Penny Post Card

**LAFAYETTE RADIO, Dept. RJ-7**  
100 Sixth Ave., New York 13, N. Y.  
Please send new Lafayette Radio Catalog at once.

Name.....  
Address.....  
City.....Zone.....State.....

**Broadcasting from  
Planes**

(Continued from page 67)

of inaccessibility to any portion of the crankshaft for power transmission.

In large planes it is possible to install a complete gasoline driven generating plant. This requires careful precautions against fire hazards.

Wind driven generators, if procurable, are an excellent solution. Propeller-driven d.c. generators can be used to keep the batteries up to full charge where a storage battery converter has been installed. If the owner can obtain a 60-cycle wind-driven generator with a 110 volt a.c. output, any conventional amplifier could be used. Wind-driven generators of 400 cycles have been built for aircraft electrical requirements. These are lighter in weight than the 60 cycle models, and would be most suitable, especially where the amplifier is designed for 400 cycle supply. For 100 audio watts to operate a 100-watt loudspeaker, the generator should have a capacity of 300-500 watts. Where 200 to 300 audio watts are required the generator should have a capacity of 750 watts.

**Amplifier**

As pointed out elsewhere, weight can be saved where the amplifier is custom-built to the precise requirements of the installation. Assuming a carbon microphone of the close talking type is to be employed, the amplifier need have no more than 70-80 db. gain. This is easily obtained in a 3-stage amplifier. It is recommended that the output stage be designed around a pair of 811 tubes operating in push-pull "Class B." This will afford power output in the neighborhood of 150-200 audio watts when using a plate supply of 1500 volts. The generator delivering the high voltage for the plate supply should, of course, be capable of meeting the peak current requirements.

Of course, high-powered amplifiers can also be designed to operate around a group of 6L6 tubes with a plate voltage of 400-450 volts. This lower plate voltage may be found more desirable because of the availability of genmotors delivering this output. The output stage should consist of six 6L6's arranged in push-pull multiparallel. This should be designed for "Class AB" conditions and will deliver close to 100 watts.

**Loudspeaker Installation**

Since loudspeakers of the order of 100 watts or more are designed to utilize a group of individual driver units mounted on a common mixing chamber and air column, a great deal of flexibility in wiring is available. This makes it possible to utilize a group of medium-powered amplifiers. For instance, the University Model 4A4, 100-watt loudspeaker contains



**New NZ-10  
NEUTRALIZING  
CONDENSER**

The improved design of the NZ-10 features smooth micrometer capacity adjustment and positive locking. Suitable for either single ended or push pull stages the NZ-10 has particular application in high frequency circuits where very fine capacity adjustment is required.



**HAMMARLUND**

THE HAMMARLUND MFG. CO., INC., 460 W. 34TH ST., NEW YORK 1, N. Y.  
MANUFACTURERS OF PRECISION COMMUNICATIONS EQUIPMENT

**SURPLUS SAVERS**

- TRANSFORMERS—115v, 60 cycle; 430-0-430-510 mls; 5.2v at 6 amps. NEW; grey case, Acme porc. terminals **\$6.75**
- 350-0-350—250 mls; 5.0v C.T. at 3 amp; New; cased Langevin... **\$3.50**
- AUTO TRANSFORMER—Acme—220-110 (6 taps) step-up or step-down. 500-watt. New **\$9.95**
- 25-watt SIGNAL CORPS TRUMPETS complete with driver unit and UTC output transformer, tapped at 250-500-1000-2500 ohms. New. Each **\$20.**

- Also packed in lots of 4 in H.D. trunk for portable. Complete 4 in trunk. New **\$65.**
- I.R.C. wire-wound RHEOSTAT 100-watt 1.1 ohm; off-on toggle switch, mtd. on control shaft. Excellent for filament control, etc. New with knob **\$1.75**
- UTC Band Pass FILTER passband; 500-2000 cycles. Useful as filter in peak clipper circuit. Second method of connection band-pass of 900-1200 cycles; use for Audio selectivity in CW reception. New, with hookups **\$1.25**
- Control box for Collins transmitter. Contains plug & 7 deck SP, 10 pos. sw. and SPDT rotary sw. New. Each **\$0.75**
- Control box for 2A gear. Contains switches, plugs, pilot lamp, etc. Each **\$1.00**

25% deposit required on all C.O.D. orders. Prompt delivery assured. Write Dept. RNS.

**GREENWICH SALES CO.**

59 Cortland St. Whitehall 3-3052  
NEW YORK CITY 7, N. Y.



# BIG NEWS

EXTRAY!!

# ... FOR RADIO SERVICEMEN AND DEALERS!

Here are the Extra Special Deals on top condition, slightly-used Test Equipment typical of the amazing bargains Walter Ashe is in a position to offer. Let us quote you on the deal of your choice.

## DEAL No. 1

Feiler Signal Tracer, regular price \$ 9.85  
 Jackson 637TT and VOM, regular price 80.00  
 Philco 670 Signal Generator, regular price 39.95  
 Total Value \$129.80  
**OUR SPECIAL PRICE ONLY \$65.00**  
 YOU SAVE \$64.80.  
 (Subject to prior sale)

## DEAL No. 2

McMurdo Silver Sparx, regular price \$ 39.90  
 Superior PB-100 Volt-OHM-Milliammeter 27.50  
 Monitor Crystaliner, regular price 57.50  
 Simpson 305 Tube Tester 48.50  
 Total Value \$173.40  
**OUR SPECIAL PRICE ONLY \$85.00**  
 YOU SAVE \$88.40.  
 (Subject to prior sale)

## YOUR FAVORITE BRANDS OF TEST EQUIPMENT

Hickok  
 Jackson  
 Precision  
 Simpson  
 McMurdo Silver  
 Radio City Products  
 Robson-Burgess  
 Chicago Industrial  
 Special Products Co.  
 Industrial Equip't  
 Cornell Dubilier  
 Coastwise Electronic  
 Waterman

Du Mont  
 Feller  
 Meissner  
 Triplett  
 Reiner  
 R.C.A.  
 Billey  
 Hanlan  
 Monitor  
 Flies  
 Weston  
 Sprague

Other used Test Equipment combinations at comparable savings are generally available. Write for complete details or use the handy coupon below. And if you're interested in trading new for old, our complete stocks and bigger-than-ever trade-in allowances on your used equipment are sure to please expert and apprentice alike.

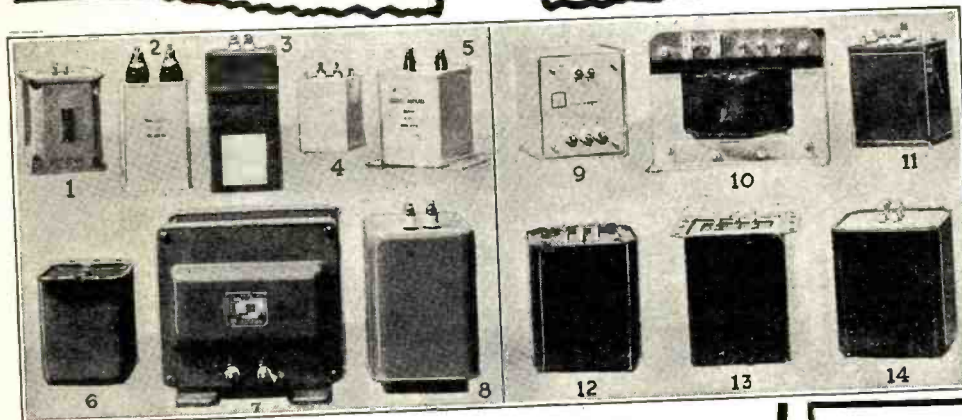

### SURPLUS CHOKES, TRANSFORMERS AND CONDENSERS

- (1) FILTER CHOKE. 12HY @ 200 MA, 200 ohms DC Res. Steel Case. \$3.50
- (2) TRANSMITTING FILTER CONDENSER. 2 Mfd. 5000 VDC. Dykanol. regular net price \$29.63. Our low bargain price \$7.51
- (3) DUAL CHOKE. 12 HY @ 200 MA per section. 150 Ohms DC res. Steel case with standoff insulators. No. 2785. \$4.95
- (4) FILTER CHOKE. 4 1/2 Hy. 150 MA. 70 ohms Res. DC. Hermetically sealed in case. Stand-off insulators. No. 5209. \$1.29
- (5) TRANSMITTING FILTER CONDENSER. 2 Mfd. 4000 VDC. oil filled. Regular net price \$25.44. Our give away bargain price \$4.50
- (6) FILTER CHOKE. 4 Hy. 300 MA. 40 ohms DC resistance. Hermetically sealed in case, screw terminals. No. 6317. \$4.95
- (7) HIGH VOLTAGE FILTER CHOKE. 6 Hy. at 1.2 Amps. 27 ohms. DC resistance. 12500 volt breakdown insulation. Shielded case and standoffs. No. 6813. A super buy at \$17.95
- (8) FILTER CHOKE. 8 Hy. at 500 MA. 55 Ohms DC res. Very high quality. Hermetically sealed. No. 8056. Net \$11.85
- (9) PLATE TRANSFORMER. 2500 VCT. 150 MA. Pri. 115 VAC. 60 CY. Steel case with standoff insulators. No. 161919. \$9.95
- (10) RCA 1 KW MODULATION TRANSFORMER. Primary will match class "B" tubes up to 10000 ohms plate to plate. Secondary No. 1. 450 MA for beam tube plate. Secondary No. 2. 80 MA for screen grid. \$14.95
- (11) SCOPE / TELEVISION TRANSFORMER. 2100 volts at 10 MA. Pri 115 VAC, 60 Cy. Steel case with standoff insulator. No. ST. 1. \$4.25
- (12) PLATE TRANSFORMER. 2010 VCT 200 MA Pri. 105-125 VAC 60 Cy. Steel case, screw terminals. No. 8275. \$9.95
- (13) PLATE TRANSFORMER. 1400/1200 VCT at 200 MA. Pri. 115 VAC 60 Cy. Steel Case, screw terminals. No. 4891-N. \$7.45
- (14) PLATE TRANSFORMER. 1400/1200 VCT at 200 MA. Pri. 115 VAC 60 Cy. Hermetically shielded steel case, screw terminals. No. 8931. \$7.95

## ARMY SURPLUS HEADPHONES



Type HS-23. 8000 ohms impedance. Adjustable leather headband. Rubber cushions. Brand new. In original box. \$1.29  
 When ordering, add 20c to cover cost of postage and insurance.

- Throat Mikes. 200 Ohm carbon. 35c
- WHEN ORDERING, ADD 17c TO COVER COST OF POSTAGE AND INSURANCE.
- PE-103 Generator. Brand new Dynamotor Power Supply. Operates from 6 or 12 volt. Delivers 500 volts D.C. at 160 M.A. \$9.95
- Amphenol All-Wave Antenna. Provides interference-free reception on FM Standard Broadcast and Short Wave Bands. No. 124-001. \$17.49
- Selsyn Motors. 115 VAC 60 CY. Navy Surplus Selsyn Motors, large, continuous duty type. No. 806, per pair. \$12.50



## HI POWER FOTO FLASH KIT

### THOROUGHLY PROVED AND TESTED

1. Uses AMGLOW 54R4X 200 watt second flash tube.
  2. Uses parallel bank condensers. 25% safety factor. No costly replacements.
  3. Synchronizer adjustment control.
  4. Light Weight, Heavy Duty, Army Surplus, High Voltage Transformer.
  5. Unit can be fired every 3 seconds if necessary.
  6. Neon bulb charge indicator.
  7. 1/10,000 Second exposure.
  8. Triggered by hand switch or synchronizer.
  9. Sockets for connecting all cables.
- Complete Kit including AMGLOW tube, carrying case, etc. with simple assembly and operating instructions. Price subject to change without notice. \$77.50  
 Write for detailed description and parts list.

## MAIL THIS SPECIAL COUPON TODAY!

Walter Ashe Radio Co. RN-9  
 1125 Pine St., St. Louis 1, Mo.

Please send money-saving details covering your Extra-Special Deals on Top Condition, slightly used Test Equipment. I am particularly interested in the following equipment:

Send details of your liberal Trade-In offer. I would like to trade \_\_\_\_\_ for \_\_\_\_\_ (describe equipment) (make, model)

Put my name on your mailing list to receive the new, bigger, better Walter Ashe Catalog when issued.

NAME.....  
 ADDRESS.....  
 CITY..... ZONE..... STATE.....

WØJWD WØULH WØWTM W9NRF WØ1YD WØPGI WØQDF

# Walter Ashe RADIO CO.

1125 PINE ST. • ST. LOUIS, MO.

*For Faster Soldering*

**5-SECOND HEATING**

Ready to solder in 5 seconds.

**LESS TIP RETINNING**

Heats only when needed.

**FAST COOLING**

Ideal for service calls.

# WELLER

## SOLDERING GUN

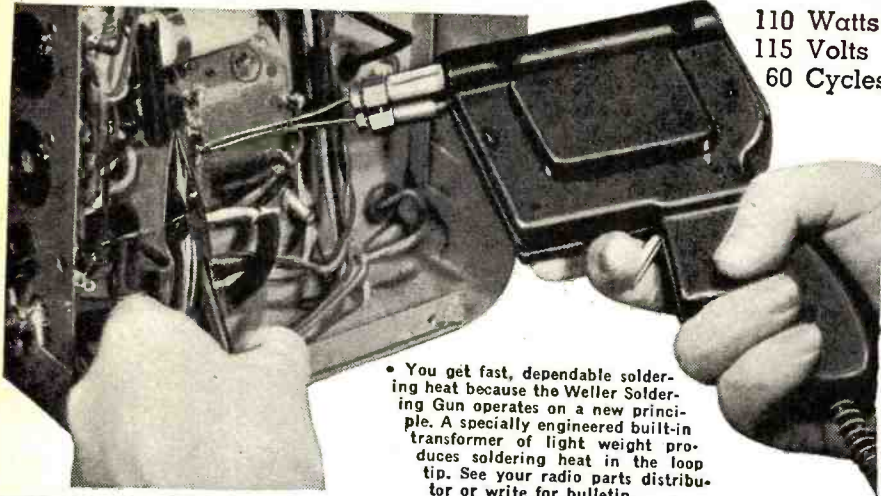

110 Watts  
115 Volts  
60 Cycles

• You get fast, dependable soldering heat because the Weller Soldering Gun operates on a new principle. A specially engineered built-in transformer of light weight produces soldering heat in the loop tip. See your radio parts distributor or write for bulletin.

**WELLER MFG. CO. 810 Packer St., Easton, Pa.**

In Canada: Atlas Radio Corp., Ltd., 560 King St., N. W., Toronto, Ont.  
Export Dept.: 25 Warren St., New York 7, N. Y.

### WANTED

#### Your Name for Our Mailing List

*Write for our latest bargain catalog of parts and equipment.*

Aerovox GL Can Condensers. 8 Mfd at 600 V. From Stock .....	\$1.69
Ward SC-1 Side Cowl. 66". 36" Low-Loss Lead....	2.35
Bypass Condensers. Manufacturer surplus—no G.I. .005 and .01 at 600. Fresh—Clean. 10 for.....	.49

20% deposit on all C.O.D.  
Please include Postage.

**RADIO EQUIPMENT CO.**

377 E. Main St.

Lexington 34, Kentucky



## Save the easy, automatic way —with U.S. Savings Bonds

Of all the ways of saving up a tidy sum of money, one of the *easiest* and *safest* ways is to invest your money in U. S. Bonds.

You can buy Bonds either through the Payroll Savings Plan at your place of business—or if the Payroll Plan is not available

to you, but you *do* have a checking account, through the Bond-a-Month Plan at your local bank.

Both ways repay you \$4 for every \$3 you save, by the time your Bonds mature. Choose the sum you can afford—and start saving today!

four driver units, each rated at 25 watts. They can thus be wired to four amplifiers each with 25 watts output power, or connected so as to be fed from two amplifiers of 50 watts output each.

The *University* Model B-6 loudspeaker rated at 150 watts contains six individual driver units inside the housing. The Model B-12 loudspeaker rated at 300 watts contains 12 driver units, each of 25 watts capacity. Thus, a number of output stages or boosters of, say, 50 watts each can be used and these are commercially available from a number of amplifier manufacturers. This type of installation, namely the utilization of several power output stages, affords a great deal of safety factor since if one of the power stages should fail, there remains sufficient power to keep the equipment operating without complete interruption of the service.

#### Installation in the Piper Cub

When the installation is to be temporary, the door of the plane should be removed and the loudspeaker mounted at such an angle that the sound can be projected downward and somewhat to the rear. The mouth of the horn should project six inches to 1 foot outside of the cabin.

For a more permanent installation in a Cub, the rear seat and the rear floorboard should be removed and a hole corresponding to the diameter of the loudspeaker should be cut into the fabric at this point on the bottom of the fuselage, just back of the rear control stick. The loudspeaker should be securely braced inside the cabin, standing directly over the opening of the fuselage. This type of installation offers no parasitic drag to the aircraft but may cause acoustic feedback. The edges of the hole in the fabric must be properly protected against possible wind damage and must conform with CAA requirements. A wire mesh screen should be used across the hole, held down with two plywood escutcheons or large washers, one inside and one outside which would reinforce the fabric edges.

In other models of ships it is possible to locate the loudspeaker under the fuselage between the wheel struts. This is an excellent location. In all cases the airplane must have adequate pay load for the weight of the sound equipment and this equipment must be so located in the plane that it does not upset its center of gravity, especially laterally. For a longitudinal displacement of the center of gravity, the trim tab or stabilizer can, of course, be adjusted for correction.

The removal of the door, the opening of the fabric, and the installation of heavy equipment may involve special permission from the Civil Aeronautics Authority. Whenever changes in the plane structure or serious redistribution of weight results, the CAA should be notified. Generally such permission, with special restrictions, is given but in many cases the

NC license is replaced by a NR or "restricted" one.

A complete high-powered sound system for reliable high altitude operation would weigh almost 300 pounds. This is proportioned as follows: Loudspeaker (100 watts)—60 pounds; Amplifier—75 pounds; Storage Batteries and Converter—150 pounds; a total of 285 pounds. —50—

### CITIZENS' BAND OPENING NEARS

THE day when individuals will be able to use small radio receiver-transmitters for private purposes moved a step nearer reality today when the Federal Communications Commission proposed technical requirements and procedure for obtaining type approval of equipment to be used in this contemplated new service.

In its frequency allocations report of May 25, 1945, the Commission set apart the band of 460-470 mc. for this purpose. Subsequently, and in cooperation with manufacturers and others interested, the Commission's engineering staff worked out technical standards for the equipment to be employed. Every effort has been made to keep these requirements to a minimum consistent with the need for apparatus that is reasonably low in price and whose operation will not require technical skill, yet will permit the widest possible use with the least amount of interference to other radio operations.

Pending the establishment of the Citizens' Radio Service, no licenses are being issued to the general public except on an experimental basis. However, as soon as approved equipment is available for operation in the assigned band and when the Commission has drafted rules and regulations governing such use, the public will be notified that the new service is here and that applications from interested individuals will be received.

(Editor's Note: The FCC technical report as it stands now definitely indicates that only commercially built equipment can be used for operation in the Citizens' Band.)

As in the case with all types of radio operation, authorization will be necessary. In the case of the Citizens' Radio Service, the Commission contemplates a simple procedure requiring no technical knowledge by the prospective user.

It should be pointed out that war surplus "walkie-talkies" will not operate in the band designated for citizen's use. This military equipment was designed for particular frequencies which could be used overseas but which, if employed in this country, would interfere with marine, police, fire, and other radio services. It is impracticable to convert this apparatus, since an uneconomic degree of rebuilding would be involved.

Due to these and other considerations, it is illegal for the unauthorized individual to attempt to use surplus radio transmitting equipment. Under the Communications Act, no person may operate a radio transmitter without first obtaining a license from the Commission. Violators are subject to possible fine or imprisonment, or both. And the Commission's monitoring stations are quick to detect unlawful transmission! —50—

September, 1947

# TOROIDAL COIL FILTERS

for every application

Our toroid filters have become a by-word in every phase of electronics where only the best results are acceptable. Toroidal coils wound on MOLYBDENUM PERMALLOY DUST CORES are the primary basis for our success in producing filters unexcelled in performance.

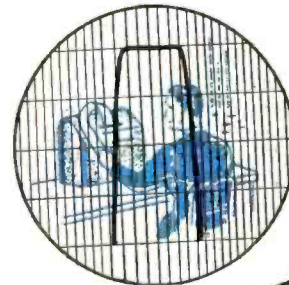
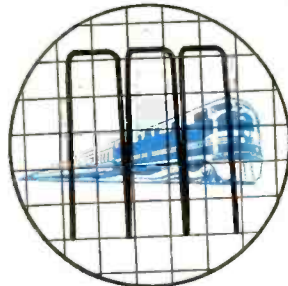
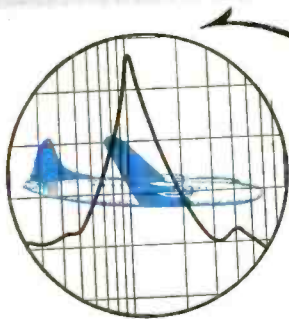

#### ELECTRONIC WARFARE

Radio control—miniaturizing  
—Aircraft. Nuclear research.

#### RAILWAY COMMUNICATIONS

Multi channel filters for carrier modulation.

#### RADIO COMMUNICATIONS

Tone keying filters — wave shaping filters — discriminators — delay networks.

#### WIRED TRANSMISSION

Line filters—slope equalizers loading circuits.

We would be pleased to submit quotations for special filters.

Write for our catalogue.

### TOROIDAL COILS

Although the demand for our toroidal coils has been increasing rapidly, we are maintaining our usual good delivery schedules.

Most available types are:

#### RANGE

TC-1	500cy.—20KC
TC-2	100cy.—5KC
TC-3	10KC—100KC

Coils are available in inductances from 1 MHY to 12 HYS.

*Burnell & Co.*

DESIGNERS AND MANUFACTURERS OF ELECTRONIC PRODUCTS

45 WARBURTON AVE.  
YONKERS 2, N. Y.

*-In New Jersey...*  
*...it's* **VARIETY**

Sensationally New

**TRANSMISION**

**TELEVISION KIT**



Ready for easy rapid assembly. No knowledge of television required. Complete easy-to-follow instruction sheet gives you all the knowledge you need.

Reception is clear and sharp... comparable to a moving picture.

All necessary components are included. Nothing is required except a screw driver, cutting pliers and a soldering iron. Only the highest quality standard parts are used—the list price value of these parts alone is more than \$300. 110 volts, 60 cycles **\$159.50** A.C.

**BALLENTINE PHONO MOTOR**

with Turntable ..... **\$4.29**

**ASTATIC PHONO PICK-UPS**

with L70A Crystal and Hardware ..... **\$1.98**

**APPROVED 6 FT. RUBBER LINE CORD**

with Gilbert Plug, 12 for ..... **\$1.98**

**APPROVED 6 FT. RUBBER LINE CORD**

with Molded Rubber Plug, 12 for ..... **\$2.50**

**WEBSTER RECORD CHANGER**

Model 50 ..... **\$21.17**

**FEDERAL BATTERY CHARGER**

rated 6-3 amps, 6 volts, 3 cells ..... **\$16.96**

**GUARANTEED VOLUME CONTROLS**

Less Switch..... 48c 10 for \$4.45  
 With Switch..... 59c 10 for 5.45  
 500,000, 100,000, 25,000 ohms; ¼ meg, 1 meg, 2 megs.

**FEDERAL SELENIUM RECTIFIER**

6 or more ..... **.99** ea.  
 Less than 6 ..... **\$1.09** ea.  
 Also available 150 Mil and 200 Mil.

**Bargain! Guaranteed!**

**100 Assorted Bypass Condensers 600V**  
 Value \$11.00. **\$6.95**  
 SPECIAL

**SUPERIOR Model 670**

**Super-Meter**

A Combination Volt - Ohm Milliammeter plus Capacity Reactance Inductance and Decibel Measurements.

Complete with test leads and instructions..... **\$28.40**



Full line of Weston-R.C.P.-Supreme-Superior-E.M.C.-Test Equipment

Write Dept. N-7. 20% Deposit with order required. Please add sufficient postage. Excess will be refunded.

**Variety ELECTRIC CO., Inc.**  
 601 Broad St., Newark 2, N. J.

For the **EXPERIMENTER**



**WIRELESS MICROPHONE**

Microphones which may be connected to the family radio have long been a popular item with the experimenter. At parties they often serve as a means of entertainment.

Unfortunately, connection of these microphones often involves considerable work, the problem varying widely with different types of receivers. In many cases it is necessary to have a circuit diagram of the receiver, and changes of the wiring are required.

For several years, wireless record players have been used, permitting the playing of records through any standard radio, with no physical connections between the record player and radio. This permits the record player to be placed in any convenient spot, and the radio tuned to its carrier frequency.

By a few simple changes in the circuit of the conventional record player, this type of instrument may be used as a wireless microphone, in the same manner as a record player. In general the only additional equipment needed is a microphone transformer and microphone. If it is desired to leave the record player undisturbed the best procedure is the construction of a separate unit for wireless microphone use.

The unit shown in Fig. 1 has a frequency range of 1250 to 1620 kc. Only one tube, a combination beam power output tube and half wave rectifier, is used. The unit may be used on any standard 117 volt line, either a.c. or d.c.

Breadboard construction was adopted using a piece of 5 x 7 inch plywood to mount all parts. The microphone transformer is mounted at the left side of the breadboard close to the tube socket.

Short lengths of tubing are used to mount the tube socket by means of long wood screws. The filter condensers and filter resistor are mounted

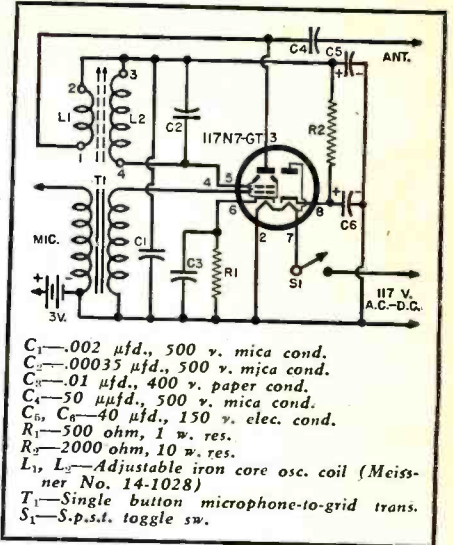

- C<sub>1</sub>—0.002 μfd., 500 v. mica cond.
- C<sub>2</sub>—0.00035 μfd., 500 v. mica cond.
- C<sub>3</sub>—0.01 μfd., 400 v. paper cond.
- C<sub>4</sub>—50 μfd., 500 v. mica cond.
- C<sub>5</sub>—40 μfd., 150 v. elec. cond.
- R<sub>1</sub>—500 ohm, 1 w. res.
- R<sub>2</sub>—2000 ohm, 10 w. res.
- L<sub>1</sub>, L<sub>2</sub>—Adjustable iron core osc. coil (Meissner No. 14-1028)
- T<sub>1</sub>—Single button microphone-to-grid trans.
- S<sub>1</sub>—S.p.s.t. toggle sw.

Fig. 2.

at the right by means of tie lugs. Brackets formed from scrap aluminum are used to support the oscillator coil and on-off switch.

A standard replacement type adjustable iron core oscillator coil is used. A fixed condenser is mounted across the secondary terminals of the coil and adjustment of the oscillator frequency is accomplished by screwing the iron core in and out of the coil. As the core is inserted farther into the coil the frequency of the oscillator is lowered.

The circuit used is essentially a Colpitts oscillator with the screen grid and plate of the tube being used as a triode. The control grid is used for injection of the modulating voltage. By using this system of modulation it is possible to obtain a relatively high modulation percentage and still retain frequency stability.

The r.f. output from the oscillator is coupled through a small condenser to the antenna terminal. The length of antenna needed will depend upon the distance from the receiver and the sensitivity of the receiver. No longer antenna should be used than needed, to prevent interference with neighboring receivers. Generally one or two feet of wire will suffice.

Microphone current is obtained from two flashlight cells. The microphone used is a surplus military type.

When construction has been completed, the unit should be plugged in, the switch closed and the tube allowed to reach operating temperature. The unit should be located near a broadcast receiver, tuned to a clear spot near the high frequency end of the broadcast band. The iron core should

Fig. 1.

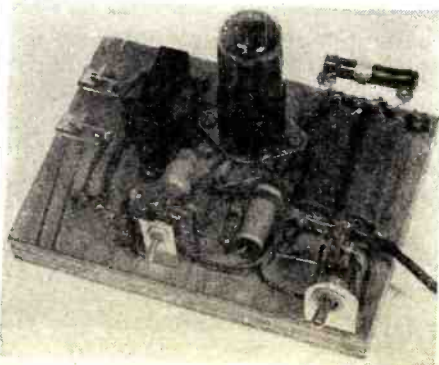

# TELEVISION-

## America's Next Giant Industry?



Billboard Announcing Telecasts of Ball Games in Chicago

Today, RIGHT NOW, clear and bright pictures of great sports events, as well as other equally interesting programs, are being telecast for the enjoyment of thousands. Television stations in New York, Chicago, Philadelphia, Washington, Detroit, St. Louis and Los Angeles are already operating on regular schedules. Construction has started in several other centers and it is believed that practically every major city in the country will have this wonderful service before the end of 1948.

Who will build, maintain, and operate the new telecast stations? Who will design, produce, install and service the receivers?

### Men Must Be Trained for These New Professions

Alert young men with an ambition to grow with television are training now in the greatly enlarged instruction laboratories of American Television, Inc. A wide choice of courses available. Advanced methods and latest obtainable equipment used.

One of Our New Buildings.  
Air Conditioned the Year Round.



September, 1947



U. A. Sanabria

Dr. Lee deForest

## The Men Who Direct American Television

The instructional quality of training is under the constant personal supervision of two internationally known engineers, Mr. U. A. Sanabria, President and Founder of American Television, Inc. and Dr. Lee deForest, the famed inventor of the radio tube.



### FREE PRE-ENTRANCE COURSE

A Short Home Study Television Course is available to qualified war veterans who are considering residence training. This course is free of any charge or obligation. Your success with it will help you to learn your own abilities in television. It will also aid us greatly in qualifying you for residence training. Your acceptance of the Home Study course in no way obligates you to enter our residence school. So we urge you to take advantage at once of the very unusual opportunity it offers.



Approved for Veteran Training Under G. I. Bill of Rights

## American Television, Inc.

5050 BROADWAY

CHICAGO 40, ILLINOIS

### REQUEST FOR FREE INFORMATION

American Television, Inc., Dept. of Information  
5050 Broadway, Chicago 40, Illinois

Please send details of your Television Training.

NAME \_\_\_\_\_

ADDRESS \_\_\_\_\_

CITY \_\_\_\_\_

ZONE \_\_\_\_\_

STATE \_\_\_\_\_

I am a veteran

# FOR HIGH FIDELITY AT LOW COST! -the UNIVERSITY TWEETER

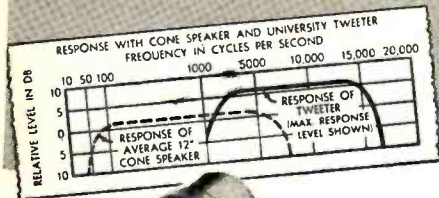

DUAL  
TWEETER UNIT

The reproduction of music and voice with breath-taking realism, is now possible with the new UNIVERSITY Dual Tweeter. Used in conjunction with any standard 12" cone speaker in FM and AM radio equipment and wide range phonograph amplifiers, it adds the brilliant "highs" so frequently carried through all stages of amplification, only to be lost in the bottleneck of a single unit reproducer. Frequency response is 2,000 to 15,000 cycles. The die-cast dual horn design offers wider dispersion angle than the conventional single cellular horn—horizontal distribution is 100°, vertical distribution 50°. A high pass filter with auxiliary high frequency volume control, permits easy connection by merely attaching two wires to the existing speaker. Compact dimensions require a mounting space only 2 3/4" high x 9 1/2" wide. Power handling capacity of the dual unit is 16 watts. For complete information write today to UNIVERSITY LOUDSPEAKERS, INC. 225 Varick St., New York 14, N. Y.

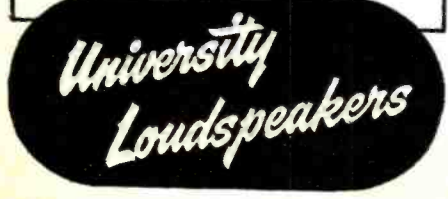
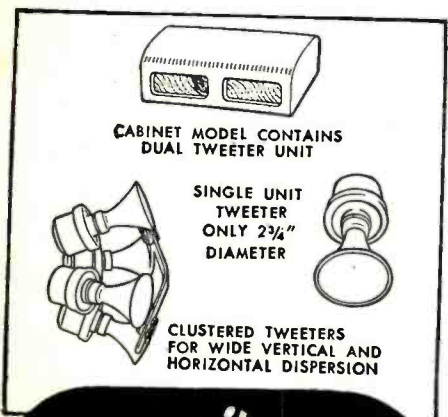

then be adjusted until the carrier is heard in the receiver.

The microphone and batteries may now be connected and the unit is ready for operation.

## BYPASSING

The term "bypass" is frequently used in radio and electronic literature, and is applied primarily to condensers. A dictionary definition of a bypass condenser is "a condenser connected to provide a low-impedance path for radio-frequency or audio-frequency currents around a circuit element."

All of us are probably more familiar with screen and cathode bypassing than with other types and so a brief word on this subject may be helpful in designing new equipment or in understanding the functions of the various components in equipment already designed.

In this case, the circuit element being bypassed is either the screen or cathode resistor. In most applications, the screen and cathode voltages should be held constant, and so some means must be provided for preventing the variable components of plate or screen current from flowing through these resistors. This is done by providing a low impedance path around these resistors, through which the variable components of current flow.

The term *low impedance* is relative, that is, the actual value of impedance which can be termed *low* depends on the value of resistance or impedance being bypassed. For most practical applications, the impedance may be considered sufficiently low if it is one-tenth or less of the component being bypassed.

We must also consider the operating frequencies in the circuit. Since the reactance of a condenser increases as the frequency decreases, we must choose a condenser which has sufficiently low reactance at the *lowest* frequency which we wish to amplify. This is true both for audio frequencies and radio frequencies. Thus, for proper bypassing, a condenser must be chosen which has a reactance of one-tenth or less of the circuit element being bypassed at the *lowest operating frequency*.

One or two examples may serve to clarify the above explanation. Suppose an audio frequency amplifier stage is being designed which is to amplify down to 50 cycles, and which has a cathode bias resistor of 1000 ohms. We must then choose a cathode bypass condenser having a reactance of 100 ohms or less (one-tenth of 1000 ohms) at a frequency of 50 cycles. The reactance of a condenser is given by the following equation:

$$X_c = \frac{1}{2\pi fC}$$

Where  $X_c$  is in ohms,  $f$  in cycles, and  $C$  in farads. Solving for  $C$  gives:

$$C = \frac{1}{2\pi fX_c}$$

## Ever Sit On A Gold Mine?



YOU can build a business of your own NOW — either part or full time — with TRADIO, the radio functionally designed for coin-operation in hotels, motels, stopovers, hospitals, etc. Big earnings . . . Steady income . . . and no clock to punch unless you want to.

### ★ ONLY SMALL INVESTMENT NEEDED

Tradio has pioneered in this new and fast growing industry. Get in on the ground floor and assure yourself of financial independence for life.

### ★ TRADIO IS TRIED, TESTED and PROVEN

Thousands of others all over the country have learned that "Tradio Pays While It Plays." Send for complete information today.

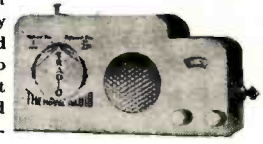

Write To Dept. P-9

**TRADIO, Inc.** ASBURY PARK NEW JERSEY

## SOLA

### CONSTANT VOLTAGE TRANSFORMERS

60 WATT	.52 AMP	\$15.00 Ea.
500 WATT	4.35 AMP	49.95 Ea.
1000 WATT	8.70 AMP	94.50 Ea.

Primary 95 to 125V. single phase  
**BRAND NEW**

---

### TRANSMITTER RECEIVER

B.C. 1267-A NEW  
154 to 186 M.C. **\$27.50**  
Complete with 21 Tubes Ea.

R. A. 105-A

### POWER SUPPLY

Complete with 7 Tubes **\$24.95**  
NEW

R. C. 148-C I.F.F.

### BOTH UNITS

Mounted in Steel Rack, in Transit Chest with T.M. **\$47.50**  
NEW.

832-A . . . \$2.19	5U4-G . . . \$0.59	6 x 5 . . . \$0.65
3 AP1 . . . 2.95	5 BP1 . . . 3.50	5 BP4 . . . 3.50

A LARGE SELECTION  
of Plate, Power, Filament and Scope Transformers; Chokes and Oil Filled Condensers.  
Send for Free Circular.

SATISFACTION GUARANTEED  
Sorry — No C.O.D. Lowest Surplus Prices.  
F.O.B. Chicago. Subject to Prior Sale.

### QUAD ELECTRICAL SUPPLY

1650 N. DAMEN AVE. CHICAGO 47, ILL.

# Start your own RADIO SERVICE SHOP

Choose one of these  
3 GREAT NEW DEALS

\$99<sup>50</sup>

\$179<sup>50</sup>

\$350<sup>00</sup>

Includes TEST EQUIPMENT, TUBES, PARTS, TOOLS

3 complete going-in-business packages. (If necessary they can be changed to suit your needs.)

There never was a better opportunity than now to start a profitable business of your own. No fuss, no worry. Here's everything you need. Details upon request. Write, wire or phone!

## Featherweight Miniature TEST INSTRUMENTS

Compact — Accurate — Priced Right!

- Jeweled Meter • Range Selector Switch
- All multipliers bridge tested for 1% accuracy
- Zero adjustment—built in batteries
- Molded bakelite case only 3-15/16" x 2-7/8" x 2"

### MODEL 451A AC-DC Volt—Ohm— Milliammeter

A dependable instrument of wide utility—sensitivity 1000 ohms per volt.  
Ranges: Volts AC, DC, and Output Ranges,  
0-10/50/100/500/1000;  
Ohms full scale, 500,000.  
Ohms center scale, 7200.



NET complete with batteries.....

14<sup>90</sup>

### MODEL 312 Volt—Ohm— Milliammeter



An economy pocket meter featuring a 2" moving vane meter.  
Reads: AC-DC volts,  
0-25/50/125/250;  
Mills AC-DC, 0-50;  
Ohms, 100,000;  
mfd. .05-15.  
Jacks provide range selection.

NET Complete with cord and plug.....

6<sup>75</sup>

### Triple FAMOUS "LITTLE TRIPLETTS"

The little Testers with the big 3" Meters  
Bakelite cases 3 1/8" x 5 7/8" x 2 1/4"  
Range selection switch—long, easy to read  
scales. We made a good buy—here they are  
at rock-bottom prices—The greatest buy  
ever offered in precision testing equipment.

### Model 650SC - OUTPUT METER

A 4000 ohm constant impedance  
AC volt meter with ranges of 0-1.5-  
6-15-60-150 volts. Conversion  
chart for reading DB level from—  
10DB to +35 DB. 100 microampere  
meter. Excellent for receiver  
alignment, level indicators in re-  
cording equipment, general use on  
electronic apparatus. Regular net  
24.50. A "one time only"  
Special  
buy at.....



10<sup>49</sup>

### Model 606B-VOLTAGE TESTER

Checks voltage and polarity.  
Range: 0-440 AC-DC volts—defi-  
nite indications for 115, 220, and  
440 volt lines. Separate polarized  
vane for AC or DC indication.  
Built in test leads. Excellent for  
checking wiring, fuses, general fac-  
tory installation and maintenance.  
Every plant — every electrician  
needs several at this low  
price. Regular net 16.67  
Special at.....



8<sup>95</sup>

### RADIART AERIALS

The Quality leader • Recognized by  
everyone • Admiralty brass rods •  
Triple plated • Permanently rattle  
proof • Static muffler ball • Poly-  
ethylene insulated HI Q lead with pro-  
tective vinylite covering • Supplied  
with single pin (Motorola) connector  
and adaptor for bayonet style (Delco  
and Philco) fittings.



#### TYPE CF3-63

A two insulator side cowl mount—3 section  
63" rod—supplied with 3 insulators and wedge  
adaptor to fit 95% of all car bodies  
—complete with 48" lead.  
List price \$4.95—our price.....

1<sup>99</sup>

#### TYPE CFA3-63

All angle cowl or fender mount—A modern  
Radiart development—fits all body contours,  
straight or curved, cowl or fender. 3 section 63"  
rod easily adjusted to vertical with-  
out tools—complete with 40" lead.  
List price \$5.45 we sell for.....

1<sup>99</sup>

### GENERATOR CONDENSERS



PHILCO part No. 61-0177—5 mfd.—  
3/8" x 1 1/4"—4" lead-slotted mounting  
strap for easy installation—Standard  
Merchandise—not war surplus—Present  
list price \$1.00.  
Our special—  
over 85% off.....

14<sup>c</sup>

### 200 WATT SOLDERING IRON FAMOUS HEXACON ELECTRIC'S MODEL 201



#### FEATURES:

Full 200 watt replaceable element. 3/8" tinned Copper  
tip, replaceable. One piece drawn case-gun metal finish.  
6' heavy duty cord—stand included. Comfortable, well  
balanced handle. Operates on 110 volts—AC or DC.  
List Price \$8.00  
Speed up your heavy work—  
Save time—save money at.....

3<sup>69</sup>

### OUTPUT TRANSFORMERS

Clean stocks — long leads —  
mounting feet — made to fit  
where you need them.

For 6F6-6K5—to 4 ohm voice coil  
—size 2" x 1 1/2" x 1 1/2"  
50L6-35L6-25L6 to 4 ohm voice coil  
1 1/2" x 1 1/2" x 1 1/2"  
Specify quantity of each type you  
need at.....



49<sup>c</sup>

Order from the Ad  
Write - Wire - Phone

### PHONO PICKUP CRYSTALS

Standard types—Set Manufacturers close-out  
—all Guaranteed



Webster F2—Replaces L26-L40-  
L70 etc.—pin type terminals—1  
oz. pressure—1 volt output—5000  
cycle cutoff.  
List price \$5.00—you pay us.....

14<sup>9</sup>



SHURE P93—W57A—pin type  
terminals—3 1/2 oz. pressure—1.6  
vult output—6000 cycle cut off.  
List price \$4.45—our Special.....

1<sup>98</sup>



Astatic L-70—new postwar design  
—solder terminals—1 1/2 oz. pressure  
—1 volt output—4000 cycle cutoff.  
List price \$5.55—we quote you....

1<sup>98</sup>

### PHILCO BEAM OF LIGHT

Selenium cell only, no holder, postpaid...  
(Puts new life into Philco Changers)

Sapphire needle only, no mirror,  
postpaid.....

1<sup>80</sup>

1<sup>20</sup>

### ALL RUBBER LAMP CORD



Underwriters Approved brown rub-  
ber covered insulated parallel Cord—  
"zips" apart easily—non fraying—  
deluxe—way above average quality.

500'  
Roll.....

9<sup>89</sup>

### MULTI-USE WIRE



Stranded No. 22 tinned wire—glass  
"ROCKBESTOS" 1000 volt insula-  
tion—fireproof aircraft wire—a war-  
time development—at this low price  
you can use the best—

100 feet..... 45<sup>c</sup> 1000 feet..... 3<sup>89</sup>

### JEWELLED PILOT LIGHT ASSEMBLIES



- Candelabra screw base for 110 volt lamp.
- Mount in 1" hole.
- Lamps removable from front of panel.
- Available marked 1-2-3 or 4 on back of white lens.

YOUR CHOICE net.....

19<sup>c</sup>

Include full remittance with orders of \$3.00 or less.  
Include 25% deposit with all C.O.D. orders of  
\$3.00 or more. Prices subject to change without  
notice.

SEND FOR FREE CATALOG

# RADIO SUPPLY & ENGINEERING CO., Inc.

129 SELDEN AVE. DETROIT 1, MICH.

# LEEDS

The house you have known for 25 years

## Radio Transmitter & Receiver APS 13

410-420 mc., light weight, fully enclosed; 30 mc., I.F. Complete with 17 tubes, including 5-6J6; 9/6AG5; 2/2D21; 1/VR105. SCHEMATIC supplied with each unit. Only . . . **\$11.95**



Wire wound general radio type Potentiometer, precision made laboratory 25 watt 100,000 ohms; 6" diam. Brand new. . . . . **\$1.95**

300 ohm Twin Lead, indoor or outdoor cable, per 100 ft. . . . . **\$2.95**

52 ohm Coaxial Cable RG/8U; outdoor; per 100 ft. . . . . **\$4.50**

0-1 MA 3" D.C. G.E. meter. . . . . **\$3.50**

0-1 AMP 2" R.F. G.E. meter. . . . . **2.45**

500-0-500 microamps 4" W.E. . . . . **3.75**

### OIL FILLED CONDENSERS

2 Mfd 1000 VDC \$ .79	16 Mfd W.E. 400 VDC \$ .98
8 Mfd 1500 VDC 3.25	3x0.2 Mfd W.E. 4000 VDC .98
2 Mid 2000 VDC 1.75	2x0.1 Mfd W.E. 600 VDC .25
0.1 Mfd 7500 VDC 1.50	2 Mfd W.E. 600 VDC .49
2 Mid 10000 VDC 17.50	10 Mfd W.E. 1500 VDC 3.50
.02 Mfd 8000 VDC .98	7 Mfd W.E. 330 VAC 1.25

### Loudspeaker LS-6-C

Consists of P.M. Speaker, Microphone, Trumpet, with triggered gun grip handle and connecting cable. Brand New. . . . . **\$3.95**



Ohmite 50 watt adj. 25-ohm Resistor. . . . . **\$0.15**

10 for. . . . . **1.25**

Ohmite Rheostats 50 Watt 25 ohm. . . . . **.39**

25 Watt 15 ohm. . . . . **.25**

Sigma Relay 2000 ohm plug in type 4MA DC . . . . . **\$0.95**

R.F. Oscillator 68-74 MC. with 1G6BT Tube . . . . . **.50**

Bussman 8 AG 1/100 AMP Instrument Fuses, per doz. . . . . **.50**

NEONS—While they last. . . . .

2 Watt Edison base . . . . . **\$0.29**

1/4 Watt Screw or Bay . . . . . **.20**

1/2 Watt Bay or wire leads. . . . . **.08**

**CONTROL BOX FOR 522 Transceiver**—consists of 5 push button switches, 5 WE pilot light assemblies & lever switch, all mounted in metal box. Brand new . . . . . **\$1.25**

### SCHWEIN

Free and Rate Gyro. Operates from 24 V.D.C. Special. . . . . **\$5.00**

**BC-645 TRANSCEIVER**; 420-450 MC; complete with 15 tubes including W.E. 316A doorknob and conversion diagram. Brand new in original packing. Special. . . . . **\$14.95**

### NEW STOCK OF AMERTRAN TRANSFORMERS, POWER TRANSFORMERS

K-606; 117V 60 cy., 700 V.C.T. 120 MADC; 5V @ 4A; 6.3V @ 4.7A . . . . . **\$5.46**

K-602; 117V 60 cy., 580 V.C.T. 50 MADC; 5V @ 3A; 6.3V @ 2A. . . . . **3.54**

K-604; 117V 60 cy., 700 V.C.T. 70 MADC; 5V @ 3A; 6.3V @ 2.5A . . . . . **4.08**

### FILAMENT TRANSFORMERS

K-416; 117V 60 cy., 10 V.C.T. @ 8A 7500V Test . . . . . **\$3.84**

K-404; 117V 60 cy., 2.5 V.C.T. @ 10A, 7500V test . . . . . **3.24**

### OUTPUT TRANSFORMER

K-292; for PP 6L6, AB1 PRI-6600 Sec. 4/8/15/250/500 ~ 30 watts. . . . . **\$6.54**

If not rated 25% with order, balance C.O.D. All prices F.O.B. our warehouse New York. No order under \$2.00

We ship to any part of the globe

# LEEDS RADIO CO.

75 Vesey St., Dept. RNS

COrtland 7-2612 New York City 7

Substituting the above values in this equation gives:

$$C = \frac{1}{2\pi \times 50 \times 100} = 31.8 \times 10^{-6} \text{ farads}$$

or 31.8  $\mu$ fd. A 40 or 50  $\mu$ fd. electrolytic condenser would thus be the logical choice.

Let us consider a screen bypass condenser for an audio amplifier. Assume a screen resistor of 10,000 ohms and a low frequency of 50 cycles. Using the above equation gives a value of 3.18  $\mu$ fd. Here the logical choice would be an 8  $\mu$ fd. electrolytic unit.

For radio-frequency bypassing, the bypass condenser is usually much larger than would be indicated by the above line of reasoning, because the additional safety factor of the larger condenser means little if any increase in cost.

## International Short-Wave

(Continued from page 72)

tion verifies by airmail postcard from Radio SEAC, G.P.O., Colombo, Ceylon.)

Broadcast time allocated to each request program is in direct proportion to the volume of requests of each kind received. At present, in a week, there are 55 hours of popular music, 16 hours of classical, and 7 hours of swing and jazz. These figures represent the proportions of requests.

There are no full-time announcers at Radio SEAC. All of the twenty or thirty voices heard over the microphone belong to people who do other work in scripting, producing, play adaptation, program compiling, and so on.

In connection with radio broadcasting in Ceylon, we might mention that there is another (separate) outlet in Colombo, with the call of ZOH, "The Ceylon Broadcasting Station," operating on 4,900 megacycles. According to URDXC, current schedule is 0450-1145, with news in English at 0900, 1000, 1100. While this station is listed with only 7 1/2 kw. and is intended only for local coverage, I have had reports that it is often picked up with fair signal in Britain and on the Continent.

### About Ceylon

Ceylon has been a Crown Colony of Great Britain since 1802, and is an island located off the southern tip of India in the Indian Ocean, with 25,332 square miles of area, and a population (1931) of 5,312,548. The island belonged to the Dutch for 140 years, but when in 1796 Holland had to take sides with Napoleon, Great Britain took Ceylon away from them and kept possession.

\* \* \*

### This Month's Schedules

Albania—ZAA, 7.852, Tirana, heard well in New Zealand with news at 1515. (Cushen)

Algiers—Algiers, 11.835, is heard

# Iron Repair Kit

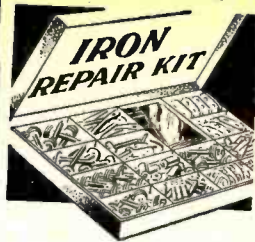

Contains a complete assortment of terminals, pins, porcelain insulators, mica, etc., that will fit most flat irons and appliances. Practically every part necessary in the ordinary repairing of flat irons in one handy kit. Additional supplies obtainable so that your kit can be replenished.

Entire kit sent postpaid for only **\$3.10**, plus 18c postage

### Electrical Appliance Repair Parts

Lead wire, Asbestos covered heater hook-up wire, 10 ft. . . . .	\$1.00
Heating element wire, 10 ft. coiled 1/4" O.D. #20 . . . . .	2.55
Heating element wire, 10 ft. coiled 3/16" O.D. #22 . . . . .	1.77
Ribbon element heating wire, Std. size 100 ft. for repairing flat irons, toasters, electric stoves, etc. Enough for 30 elements. . . . .	1.00
Hot plate bricks, 5 3/4" diameter, 6 for . . . . .	1.62
Element cement, Withstands 3000° F. 1 lb. package. . . . .	1.00
Carbon brush set. Assorted. 104 brushes. Springs. Complete . . . . .	3.00

### REPAIR ELEMENTS

#### FOR ELECTRICAL APPLIANCES

Renual Iron element, Guar. 1 year. Package of 6. . . . .	\$3.12
Irons, Porcelain shoes for 500-600 watt. Set of 4. . . . .	1.00
Percolator element, Universal flat type, 1 Yr. guar. 2 for . . . . .	1.20
Percolator element, Porcelain for new glass types, 2 for . . . . .	1.80

### HOW TO FIX IT BOOKS

Armature and Magnet Winding, 270 Pages. . . . .	\$1.50
Practical Electricity and House Wiring, 200 Pages. 277 Illustrations. . . . .	1.50
Modern Electric and Gas Refrigeration, 928 Pages. 408 Illustrations. . . . .	5.00
Electric Motor Rewinding & Repair, 551 Pages. 900 Illustrations. . . . .	5.00
Watch & Clockmakers Handbook, 551 Pages. 464 Illustrations. . . . .	6.00

Here is your opportunity to save on repairing your own appliances and to earn extra money repairing appliances for friends and neighbors.

### CHRISTY SUPPLY CO.

2835 N. Central Ave., Dept. T-456, Chicago 34, Ill.

# LOW-PRICED LARGE-IMAGE TELEVISION IS HERE!

TRANSVISION'S NEW 12" TUBE KIT

At only **\$289.50\***

GIVES YOU LARGER IMAGE THAN SETS SELLING AT \$500

Here is a television receiver with a 7 1/2"x10" screen—easy to assemble in about 20 working hours. Designed and constructed by Transvision engineers with the same technical skill which goes into their 7" kit.

Just tally some of these features:

1. 12" magnetic type picture tube,
2. Receives all television channels on the air with provision for factory to add new channels as they open at NO EXTRA COST!
3. 4 mc band width for full picture definition.
4. 9,000 volts second anode potential for brightness and contrast.
5. Ratio detector for sound gives highest quality FM reproduction.
6. 22 tubes and picture tube.
7. Complete with antenna, tubes, pre-assembled and tuned R.F. Unit.

Kit comes with simple step-by-step assembly instructions. Factory guarantees clear, sharp reproduction comparable to sets selling at twice the price.

Here's a value you can't beat! Order now and be one of the first to have one of these beautiful, new Transvision sets. A \$25 deposit will assure you early delivery. Beautifully turned walnut cabinet available at slight additional cost.

7" tube Transvision kit still available at \$159.50.

### Beacon Television, Inc.

Distributors for Transvision Television Kits Department A

143 East 49th Street, New York 17, N. Y.

DEALERS: We invite your inquiry regarding an attractive money-making deal we are prepared to make with live-wire radio men!



with fair signal on West Coast at 0130 with French. (Nankervis) Heard in Britain signing on with "Ici Radio Algiers" at 0630; has Arabic programs to 0900, then French to sign-off at 0915. (Pearce)

**Anglo-Egyptian Sudan**—Radio Omdurman, 13.320, recently following its Friday (English) news, 1230-1245, was heard acknowledging reception reports, said replies are sent in writing (probably means via letter-verie); had topical talk until close of English period at 1300. (Pearce) A 31-m. outlet of about 9.650 is scheduled in dual.

**Angola**—A station heard in Portuguese, irregularly afternoons, on 15.895, has been identified as CR6RL, Radio Clube de Angola, in Luanda. When first picked up in Pennsylvania by Kary, time was 1540-1600 sign-off with Portuguese National Anthem. (Kary, Legge) Has been heard in South Africa; calls announced were CR6RL, CR6RA, CR6RN; schedule appears to be 0100-0215, 0630-0745, also heard before 1200 and after 1500. (Laubscher) The 15.895 outlet has been heard in Sweden weekdays around 1330-1600, Sundays to 1300. (Skoog) Heard in Britain from 1300, playing Spanish, French, English recordings. (Harrison)

**Argentina**—Radio Splendid, 11.971, Buenos Aires, has fine signal in West Virginia after Brazzaville's 11.97 closes down around 2000. (Arthur)

**Australia**—VLC4, 15.32, has replaced VLC9, 17.84, to Asia and Britain, 0830-1045. (Balbi) VLC4 has

replaced VLC11, 15.21, to British Isles, 1245-1415. (Pearce)

During the summer **Radio Australia** has been using VLC, 15.200, 50 kw., to Eastern North America, evenings, 1900-2015, with news at 1930; VLA10, 100 kw., has been in dual, beamed to South America on 17.840, but by this time will have likely moved to 17.800 for this beam, having been usually inaudible on 17.840 due to QRM from Moscow (announcing 17.82 or 17.83 but actually operating on about 17.839).

In the Forces' beam, 0330-0645, VLB8, 21.60, has been replaced by VLB10, 11.74. (Radio Australia)

**Belgian Congo**—Leopoldville's 9.745 is used 1530-1645 or later in the British Isles-Europe beam, instead of 17.770; news at beginning; good signal here in the East.

**Brazil**—PRE-9, Fortaleza, scheduled 6.105, 0900-1200, 1600-1900; 15.165, 1900-2030. ZYB-7, 11.765, Sao Paulo, is heard with fair signal around 1930; severe QRM from KCBR at times; announces "Radiodifusora Sao Paulo, Emissora Sociedades de Sao Paulo, Brasil." (Kary) PSH, 10.22, PSL, 7.94, heard in dual 1700-1800. (Beck)

**British Honduras**—ZIK-2, 10.598, Belize, heard in West Virginia signing on at 1332; fair level. (Arthur) Runs to around 1400.

**British Somaliland**—Radio Somali, 7.125, verified by letter from Department of Public Relations, Hargeisa, British Somaliland; power given as 1 kw.; now using single wire antenna; heard in New Zealand to after 1000.

(Cushen) Call is VQ6MI, scheduled 0730-1000. (Radio Australia via Arthur)

**Burma**—Rangoon now verifies by card; latest schedule is reported 2015-2030, 0115-0130 on 6.035; 0840-1015 (in English) on 9.540, news at 0845, 1010. (NZDXC) (If you do not find this station on 9.540 at the time indicated above, try 6.035, as frequency in use for the English session—0845-1010—appears to alternate.)

**Canada**—CBC's international beam to Europe is scheduled CKNC, 17.82, 0845-1800; KKCX, 15.19, 0845-1100; CKCS, 15.32, 1105-2300, all daily. The beam recently inaugurated to New Zealand, Australia, and the South Pacific by CBC is transmitted at 0245-0400 over CHOL, 11.72, and CHLS, 9.610. Good reception reported from "Down Under."

**Celebes**—Radio Makassar is being heard with improved signal on 9.265, both East and West Coasts. Has "terrific" signal in New Zealand, using many English recordings; best on 9.265, but is also heard (poorly) on 5.060; scheduled 1730-1830, 2300-0130, 0500-0930. (Cushen) On Mon., Wed., Sat., has news at 0800; signs off with "A Perfect Day." (Anderson, California)

**China**—XGOA, 15.35, has been widely heard in the East mornings this summer, around 0745 (when Boston leaves that channel) to about 0920 when appears to leave the air, though is officially scheduled to 1000; news at 0800; fair to good signals, but has

# Fahnestock Clips

## RADIO'S GREATEST CONVENIENCE

### FAHNESTOCK SPRING BINDING POST GRIPS THE WIRE BY THE ACTION OF A SPRING



No tools required to make the connection. Grips the wire with just the right pressure for good electrical contact. Simply press down, insert the wire and let go. Does not injure wire, hence connection can be made or opened as often as desired. Available in large variety of types and sizes to fit any radio purpose and any requirement as to position, space or method of attachment. You will find them in the better sets.

Positive contact; cannot jar loose. Brass or bronze—nonrusting.

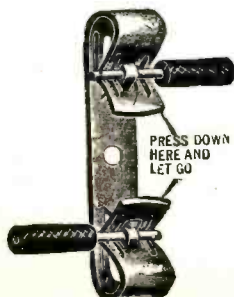
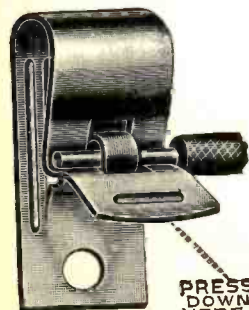

### FAHNESTOCK ELECTRIC COMPANY, Inc.

46-44 ELEVENTH STREET  
LONG ISLAND CITY 1, N. Y.

Dept. 12

Please send us at once, Descriptive Literature, Prices and Delivery Schedule on

### FAHNESTOCK CLIPS

For .....  
Name .....  
Address .....  
City ..... State .....

## WAR SURPLUS SALES

RADIO - ELECTRICAL - ELECTRONIC EQUIPMENT - PARTS - SUPPLIES

### Crystal Calibrated Signal Generator 1-222-A \$54.50

Operation from 110-117 volt, 60 cycle source, power consumed 40 watts. Self contained power supply.

#### COMPLETE WITH TUBES

Within the ranges of the FM and television IF freq and the Police, Taxi, Aircraft, RR, etc. VHF. Instruments are individually hand calibrated and use an accurate vernier-scale planetary dial.

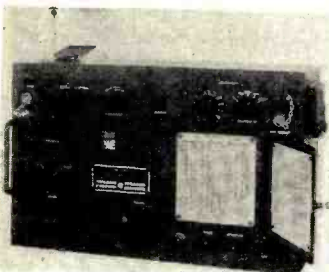

A combination signal generator and heterodyne wavemeter. It consists of a 5 megacycle crystal-controlled oscillator used as frequency standard calibrator, a variable two-range oscillator, an untuned detector with two stages of audio amplification, a sliding-rod stub antenna, a rough pi-type RF attenuator, a frequency calibration chart and a power supply. Coverage of the test oscillator on the low range setting is from 8 to 15 megacycles; the high frequency range coil covers from 45 to 76 megacycles and since the third harmonic is utilized, this gives a coverage of from 135 to 230 megacycles.

The signal generator cabinet measures 19 1/4" wide, 12" high, 7 1/2" deep; weight 50 lbs. Tubes in BC-1298 Power Supply — 16 — 6SN7GT; 1 — 5Y3GT/G; 2 — 6H6; 1 — 6SA7; 2 — 6V6GT; 1 — 6SJ7. Tubes in 1-222-A: 1 — 6J5; 2 — 9006; 2 — 6SJ7; 1 — 5Y3GT/G. An additional extra power supply and tubes, with many other small items including cables packed in wooden chest is included in this price. Gross wt. of entire equipment 490 lbs.

### RECTIFIER & BATTERY CHARGER COMBINATION

No. RA91A—Selenium plate, full wave 115 or 230v AC; 50-60 cycle, single phase input; output is 6 to 48v DC at 2 to 15 amp; manually controlled, complete with overload input and output switches, 0-15 amp DC meter. Excellent for laboratories, servicemen, service-stations. Shipping weight 150 lbs.

\$39.50

### SUPREME—Model 537 \$9.95 VOLT-OHMMETER

BRAND NEW—EXPORT PACKED 3" Full Vision type Scale, with basic 100 Microampere D'Arsonval type movement.

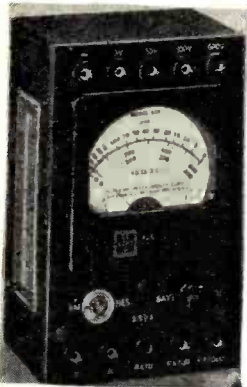

A completely self contained pocket type multimeter, with functions for the measurement of DC voltage from 0.1 to 600 volts in 4 ranges. Measurement of resistances from 1 ohm to 1,000,000 ohms (1 megohm) can be made in 4 ranges. Height 5 3/4", width 3 3/4", depth 2 1/4". Shipping weight 3 lbs. Complete with operating instructions and circuit diagram.

Prompt Delivery—Write Dept. RNS 25% deposit required on C.O.D. order Shipped F.O.B. New York. Min. Order \$2.00

**MICHAEL STAHL, INC.**

39 VESEY ST. Tel. COrtland 7-5980 New York 7, N. Y.

usual poor modulation; announces as "The Voice of China in Nanking," while XGOY still announces as "The Voice of China in Chungking." Heard best on West Coast around 0900, according to Balbi; 9.73 appears in dual and seems to continue after 0920.

On 15.35, XGOA was heard at 2200 one night announcing in the (supposedly) North American beam, scheduled for around 2000-2300. (Sutton) Consistent reception of XGOA on this frequency at night is impossible due to other occupants (Boston and Paris), with Moscow using adjacent frequencies on either side (15.340 and 15.360). What I consider a "freak" pick-up was XGOA on 9.73 which I logged here in West Virginia on July 4 at 2150-2200, through bad QRM; woman was heard announcing the station distinctly (in English); on numerous subsequent evenings I was unable to pick up anything more than a heterodyne which may have originated with XGOA. (Incidentally, Leipzig is heard well on this spot from 2200 sign-on.) The 9.73 XGOA channel is heard here in the East around 0500-0630 or later, with fair level.

Chinese stations have been coming through much better this summer here in the East. XGOY, 11.913, best around 0500-0530, asks for reports; on 15.170 is heard some mornings signing on at 0745, but soon is buried by Guatemala *except* on Sundays when is heard fair to good until around 0845 fade-out; can be separated from Moscow's 15.170 during Soviet North American beam, 0745-0815; the 9.958 channel, used 0535-0735, is badly QRM'd by Brisbane's VLQ3, 9.66, but some mornings has been readable at 0600 when has news.

XRRR, Peiping, on its 10.260 summer frequency, has been audible in the East around 0600-0730; at 0630 a man often gives call in English; reported by Kary and heard also by your editor; does not appear to carry Nanking (English) news at 0800, this being confirmed by Dilg, California; according to Balbi, usually signs off at 0945; on occasion seems to use 15.130 (Nankervis).

XORA, 11.725 (moved from 11.69—Dilg), Shanghai, and XTPA, 11.65, Canton, have been weak signals here in the East this summer, usually audible to fair around 0500-0600.

XLRA, 11.490, Hankow, is heard in Australia around 0645 with musical program. (Sanderson) Sign-off is irregular, usually around 0945. (Balbi) Chinese sources list frequencies of XLRA as 6.054 and 12.500. (Cushen)

XGOUS, 9.123, Nanking, used for press dispatches, has lately been heard as late as 1000; usually begins around 0800, may have breaks. (Balbi)

XMTA, 12.21, Nanking, is heard in Australia at 0430 with western music. (Sanderson) Has been heard on occasion this summer in East around 0600. (Kary)

Ethiopia—Radio Addis Ababa is again active on "given" frequency of 15.074, but appears to be as low as 15.050 to 15.060 where has interfer-

ence from WNC-7, Hialeah, Florida, which is used widely daytime for contacting South America. In Eastern U. S., Radio Addis Ababa has been heard from around 1325 fade-in to 1500 sign-off, playing both ancient American popular recordings and oriental music, with announcements in English and Amharic; on July 4 presented several Americans now living in Addis Ababa who sent greetings to friends in the States. Has been heard in Britain early as 1220 and testing around 0800-0954, according to Pearce. Dilg, California, has heard this station around 0845-1000, while here in the East I have received it as early as around 0700-0900. In the afternoon period, peak is towards sign-off. There is considerable interference from WNC-7 and CWQRM, but some afternoons the signal is quite good; usually is readable.

Call for broadcast seems to be ETA while ETAA is used for c.w.; usually can be heard on c.w. to New York following end of broadcast at 1500. Asks for reports; QRA is Technical Director of Radio Services, Ministry of Posts, Telegraphs and Telephones, Addis Ababa, Empire of Ethiopia. (Kary)

Finland—Helsinki's 15.193 (announced) is heard well in Eastern U. S. around 1925; comes on with chimes and music (probably National Anthem); short newscast follows; announces 9.500 in dual, and that a further newscast (also in English) is given "weekdays" on these frequencies at 0715. I do not hear the 0715 period due to Delhi operating on 15.190; and because of other stations in vicinity of 9.500 at that time.

The Finnish Radio has ordered one 100-kw. transmitter from a British radio firm; this is a prewar project, but is just now being realized. The new station will be set up at Bjorneborg "Pori" and will be completed for operation in a year and a half. It will be used largely for broadcasts to North America. (Anderson, California)

French Indo-China—A recent report by Paul Dilg, California, was acknowledged in a broadcast from Radio Dalat; among other items it was mentioned that identification slogan is "Ici Radio Dalat L'Lemetteur." Announced frequencies are 7.146 and 7.538; Mr. Dilg reports he has not heard them on the first channel, although some months ago 7.538 had a good signal early mornings; also has been heard on about 7.390, but a late flash from Mr. Dilg indicates latest frequency in use is 7.275, this being also reported by Nankervis; schedule appears to be around 0715-0845, sometimes to around 0852, news in French 0800. QRA is simply Radio Dalat, Dalat, French Indo-China (Indo-Chine).

Germany—Nordwestdeutscher Rundfunk, 6.115, Hamburg, was heard at 0750 asking for reports in English and French to North West German Network, Short-Wave Section, Hamburg 13, Rothenbaumchaussee 132;

RADIO NEWS

**ELECTRONIC**

**EQUIPMENT**

**BARGAINS**

**JOBBERS**

**WHOLESALEERS**

**MANUFACTURERS**

Large inventories of valuable electronic tubes, devices and equipment are being offered by the WAA Approved Distributors listed herewith for your convenience. Alert commercial buyers are taking advantage of this big bargain opportunity. Why not fill *your* present and future requirements from these available stocks. Act now—while inventories still permit wide selection.

Purchase of this surplus equipment has been greatly simplified. The Approved Distributors appointed by WAA were selected on a basis of their technical background and their ability to serve you intelligently and efficiently. Write, phone or visit your nearest Approved Distributor for information concerning inventories, prices and delivery arrangements. You'll find you can "Save with Surplus."

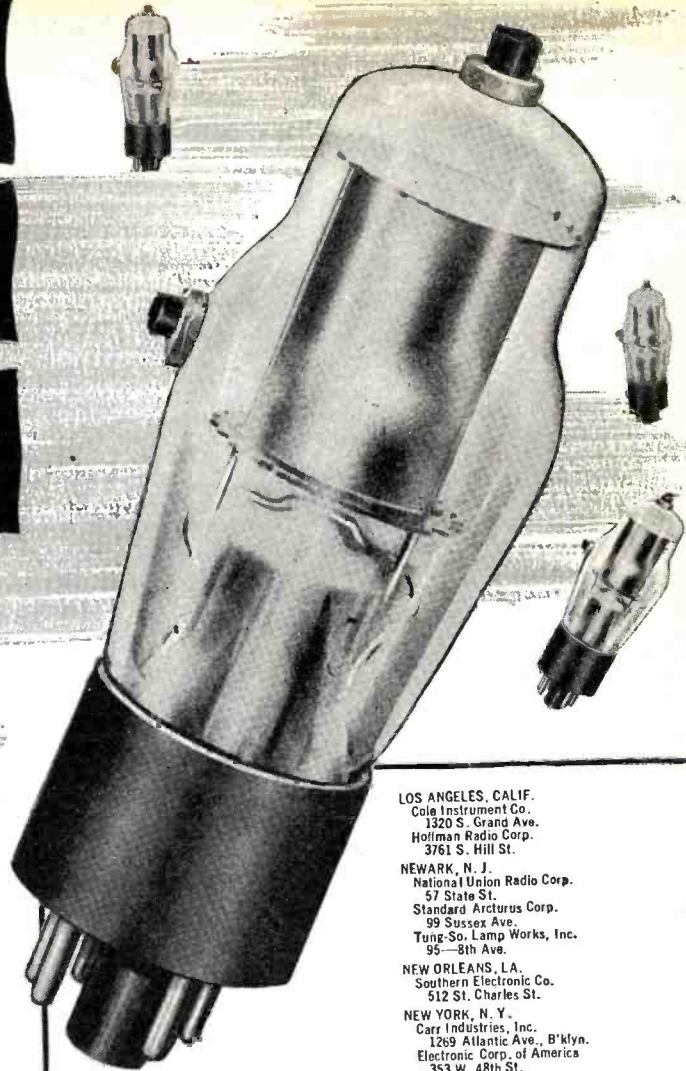

LOS ANGELES, CALIF.  
Cole Instrument Co.  
1320 S. Grand Ave.  
Hoffman Radio Corp.  
3761 S. Hill St.

NEWARK, N. J.  
National Union Radio Corp.  
57 State St.  
Standard Arcturus Corp.  
99 Sussex Ave.  
Tung-Sol Lamp Works, Inc.  
95—8th Ave.

NEW ORLEANS, LA.  
Southern Electronic Co.  
512 St. Charles St.

NEW YORK, N. Y.  
Carr Industries, Inc.  
1269 Atlantic Ave., B'klyn.  
Electronic Corp. of America  
353 W. 48th St.  
Emerson Radio & Phonograph Corp.  
76—9th Ave.  
General Electronics, Inc.  
1819 Broadway  
Hammarlund Mfg. Co., Inc.  
460 W. 34th St.  
Johanns & Keegan Co., Inc.  
62 Pearl St.  
Newark Electric Co., Inc.  
242 W. 55th St.  
Smith-Meeker Engineering Co.  
125 Barclay St.

NORFOLK, VA.  
Radio Parts Distributing Co.  
128 W. Olney Road

ROCHESTER, N. Y.  
W. & H. Aviation Corp.  
Municipal Airport

SALEM, MASS.  
Hytron Radio & Electronics Corp.  
76 LaFayette St.

SCHENECTADY, N. Y.  
General Electric Co.  
Bldg. 267, 1 River Road

WASECA, MINN.  
E. F. Johnson Co.  
206 2nd Ave., S. W.

BOSTON, MASS.  
Automatic Radio Mfg. Co., Inc.  
122 Brookline Ave.  
Technical Apparatus Co.  
165 Washington St.

BUCHANAN, MICH.  
Electro-Voice, Inc.  
Carroll & Cecil Sts.

CANTON, MASS.  
Tobe Deutschmann Corp.  
863 Washington St.

CHICAGO, ILL.  
American Condenser Co.  
4410 N. Ravenswood Ave.  
Belmont Radio Corp.  
3633 S. Racine Ave.

EMPORIUM, PENNA.  
Sylvania Electric Products, Inc.

FORT WAYNE, IND.  
Essex Wire Corp.  
1601 Wall St.

HOUSTON, TEXAS  
Navigation Instrument Co., Inc.  
P. O. Box 7001, Heights Station

OFFICE OF AIRCRAFT AND ELECTRONICS DISPOSAL

**WAR ASSETS ADMINISTRATION**



Offices located at: Atlanta • Birmingham • Boston • Charlotte • Chicago • Cincinnati • Cleveland  
Dallas • Denver • Detroit • Fort Worth • Helena • Houston • Jacksonville • Kansas City, Mo. • Little Rock  
Los Angeles • Louisville • Minneapolis • Nashville • New Orleans • New York • Omaha • Philadelphia  
Portland, Ore. • Richmond • St. Louis • Salt Lake City • San Antonio • San Francisco • Seattle • Spokane • Tulsa

September, 1947

1284

115

Post War Designed  
**TELEVISION**  
TRAINING KIT  
FOR SERVICEMEN,  
AMATEURS & SCHOOLS



Basic Kit includes **\$59<sup>50</sup>**  
all i-f, power,  
blocking oscillator transformers,  
chokes, speaker, sockets riveted  
in place on punched and welded  
chassis. Other required resistors  
and capacitors available at Dis-  
tributors.

**LEARN TELEVISION  
BY ASSEMBLY LINE  
PROCEDURE—**

NEW PICTORIAL INSTRU-  
CTION BOOK TELLS STEP BY  
STEP METHOD—16" x 24"  
SCHEMATIC BLUEPRINT  
AVAILABLE.

**NEWLY ENGINEERED**

- 18 TUBES include 15 minia-  
tures.
- 3 stage **STAGGER TUNED**  
pix i-f.
- 21.25 m.c. sound i-f—Trap  
tuned.
- Balanced f-m discriminator.
- Portable—Weights only 17 lbs.
- Uses 3 inch **Low Cost** cathode  
ray tube—4 inch magnifier  
makes ideal personal television  
set.
- Can be aligned with ordinary  
test oscillator and V.T. Volt-  
meter.

Learn Television now—work  
with miniature tubes and mod-  
ern circuits—stay with the trend  
of post war design! See your  
distributor today or write for  
further information to:

**ESPEY**  
MFG. CO., INC.  
528 East 72nd St.  
NEW YORK 21, N. Y.

appears to take broadcasts on occa-  
sion from Cologne, Hanover, and other  
points. (Pearce) I understand this  
station normally uses only the Ger-  
man language. Subsequently, this  
station has verified for Mr. Pearce,  
giving power as 50 kw. Heard in New  
York nightly signing on at 2200.  
(Beck)

*India*—Recently, best signal here in  
the East from Delhi on the 0730 news  
period has been on 17.760; 9.670 has  
been inaudible to only fair, while  
11.830 has been weak. The 15.160 out-  
let (mostly in native) is a fine signal  
in the East mornings; usually carries  
the *English* news at 0930. The 15.190  
channel is heard well with news at  
2130 and 2230; it is a good signal  
mornings, in native.

*Iran*—During the summer, EPB,  
15.100, Teheran, has been audible here  
in the East around 0700-0730 sign-off;  
news is read at 0715 by a man who  
during the period mentions occasion-  
ally, "This newscast is coming to you  
from Teheran, Iran." The news lasts  
only about 10 minutes, is usually fol-  
lowed by a popular recording or two,  
after which a woman appears to  
sign-off the station in an Eastern lan-  
guage (presumably Arabic). Announ-  
ces 49-m. outlet (6.155) in dual.

*Ireland*—Radio *Eirrean* is again  
being heard in Eastern U. S. on 9.595  
around 1610-1630 with news. Kary,  
Pennsylvania, reports weak signal  
from 17.840 around 1240-1300 with  
news. Asks for reports from North  
America.

*Italy*—Pearce, England, reports a  
station announcing as "Radio Ital-  
iana," on approximately 15.120, heard  
around 0730, with singing of nightin-  
gales at intervals.

*Jamaica*—ZQI, Kingston, is cur-  
rently operating on 4.95, 1600-1730,  
and on 3.480, 1930-2200; preview and  
headlines at 1600; news 1715; preview  
and headlines, 1930; news 2100. Re-  
cently, the Jamaica Government an-  
nounced through the press and over  
this station that they proposed to  
terminate broadcasting on their own  
account, and to permit private com-  
mercial broadcasting in Jamaica un-  
der franchise, that is, under regula-  
tions laid down by themselves. Relays  
over VRR-4 and VRR-5 from ZQI  
have been widely reported lately from  
all over the Western Hemisphere, Aus-  
tralia, South Africa, and the Conti-  
nent of Europe. (Stone)

*Java*—Batavia, 9.555, now from  
0500. (Sanderson) This outlet ap-  
pears in parallel with 10.365 and about  
4.870. (Dilig) The 9.555 frequency has  
been heard in New Zealand with news  
at 0600. (Gray) Uses 5-note bell.  
(Cushen)

*Kenya*—Nairobi has been drifting  
lately, often nearer 4.860 than listed  
4.885. (Pearce) May be experiment-  
ing to find clear channel. Is heard in  
Britain around 1300 and earlier.

*Luxembourg*—Radio *Luxembourg*,  
6.090, is heard well in Britain; on  
Sundays has request program with

(Continued on page 175)

**R. C. HAS THE  
BARGAIN VALUES  
PLUS**

- A scoop transformer assortment—power, choke,  
outputs & filament, 10 assorted. **\$12.95**
  - 1 meg volume control with tone tap and switch,  
each. **\$0.95**
  - A vibrator scoop standard 4 same as Mallory 294.  
Each **\$1.10**, in lots of 10; each **\$0.95**
  - 66" side cowl car ant., 36" lead-in. Each **\$2.00**
  - In lots of 10, each **1.85**
  - 5 tube kit containing: 12SA7, 12SK7, 12SQ7,  
50L6, 35Z5, all for only **\$2.39**
  - 3 tube AC DC portable phonographs, closeout  
special, all wired but need testing, as is, all sales  
final, each **\$10.95**
  - 18 watt amplifier, PP 6V6 output, has 6 tubes,  
black chassis with blue top. Each **\$22.95**
  - Maytone Guitar amp., Portable case with half  
back. Uses 6SL7 or 6SN7, 6J5, 6V6, 5Y3G, has  
2 inputs for 2 guitars or 1 & 1 mike, 1 gain and 1  
tone control and 10" spkr., special. **\$24.95**
  - 6" PM speakers, special, each **1.49**
  - 5 conductor rubber covered wire, a ft. **.06**
  - 3½" square meter, 0-10 ohm, 0-1 V. scale. **1.98**
  - Standard brand 8 mid. 450 V., each **.39**
  - 10 for **3.50**
  - Webster 56 changer, a 3" leatherette covered base  
given free with each changer. **\$26.66**
  - Seeburg Wall-O-Matic units remote receiver, uses  
6SR7, 2-6K7, 5U4G, 2-6V6GT tubes, 340ke  
Type RR6-5Z, AC. 60 watt output. **\$17.95**
- All items subject to prior sale, 20% deposit with  
order.

Write Dept. RN-18

**R. C. RADIO PARTS AND  
DISTRIBUTING COMPANY**

731 Central Ave. Kansas City 6, Kansas

**MEN ARE NEEDED FOR  
RADIO ENGINEERING  
TELEVISION  
ELECTRONICS**

Thorough training in radio, including fundamen-  
tals, math, repair, sales, broadcasting, communi-  
cations, with modern laboratory facilities and  
experienced faculty.

APPROVED FOR VETERANS TRAINING

Moderate tuition and living costs

New Classes Start Each Month

Dept. 1

Albuquerque, New Mexico

**EGGERT RADIO INSTITUTE**

**RADIO SERVICE MEN!**

- RCA RADIOTRON
  - TUNGSOL
  - SYLVANIA
- TUBES, PARTS AND EQUIPMENT  
Serving Eastern New York State  
Distributors of RADIO EQUIPMENT

**CHIEF ELECTRONICS**

104 MAIN STREET, POUGHKEEPSIE, N. Y.  
The Square Deal Supply House

**MILES "TELEMIKE"**

A midget unit (1¼"x1¼"x1¼") requiring no physical  
contact to telephone. PICKS UP BOTH SIDES OF  
TELEPHONE CONVERSATIONS for group loud speak-  
er listening or for recording when used with stand-  
ard amplifier or recorder. PRICE \$25.00 postpaid.  
Write for details on our complete line of FILMGRAPH  
TELEPHONE—CONFERENCE—DICTATION—"TALKIE"  
RECORDERS & REPRODUCERS.

**MILES REPRODUCER CO., Inc.**

Dept. RN-9, 812 Broadway, New York 3, New York.

**RADOR System for Automobile  
DASHBOARD CONTROL**

of garage doors and lights uses car radio as In-  
duction Transmitter. Conversion diagrams \$1.00.  
Diagram for garage Induction Relay, \$1.00. Send  
\$2.00 for both, plus additional diagrams and de-  
scriptions. Parts cheap. No radio license required.  
Patent pending.

**RADOR COMPANY**

8237 Witkop Avenue Niagara Falls, N. Y.

**RADIO NEWS**

# 10 INCH TELEVISION

now **124** <sup>50</sup> LESS TUBES

**BUILD YOUR OWN TELEVISION SET**



Completed Number 10 Telekit

## TEN INCH TELEKIT \$124.50

Never before has such a fine ten inch television receiver kit been offered for such an amazing low cost. The number 10 Telekit is designed by Television Training Institute—one of America's foremost television training schools. Thorough, easy-to-follow, step by step instruction books are furnished with each Telekit, and it's **GUARANTEED** to work.

Here is a television set that has a brilliant picture—even under fluorescent lighting—that is far superior to commercial receivers—and at only half the price! You will be thrilled with the performance of your number 10 Telekit.

If you want the advantages of a larger picture and Electro-Magnetic scanning and focusing, this set is for you. The number 10 Telekit is the first to use the new TTL interlock circuit for horizontal and vertical sync control—holds the picture steady even at low signal strength and at noisy locations. There is a big 10,000 volt R.F. power supply for the ten inch picture tube and two separate low power voltage supplies to prevent inter-action between circuits. The sound reception is high quality F.M.—without distortion to give you true listening pleasure. Pre-tuned I.F. coils are included, so that you will have no trouble aligning this fine set. Switching arrangements for five bands are included.

The price is \$124.50 for the number 10 Telekit.  
 Tubes required: 1—6J6, 1—7X7/XXFM, 1—6V6, 1—6AC7/1852, 5—6SN7, 1—6BG6/807, 4—6AG5, 1—5V4G, 1—183GT/8016, 2—5U4G, 1—10BP4 (ten inch picture tube). We have assembled these tubes for you in tube kit number 10.

\$64.50 complete.  
 Cabinet \$29.50.

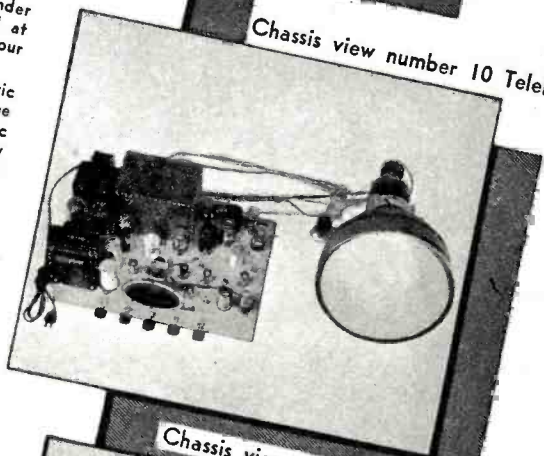

Chassis view number 10 Telekit

## SEVEN INCH TELEKIT \$77.50 (Less Tubes)

The seven inch Telekit is an easy-to-assemble television receiver kit that is **GUARANTEED** to receive sound and video of superior quality. Complete instruction books are furnished with each kit that show every step of the way. Photographs and diagrams are included so that you cannot make a mistake. The number 7 Telekit was engineered by Television Training Institute. Thousands of these sets have already been assembled here and in other leading television schools throughout the country.

Number 7 Telekit uses the simplest, most modern advanced television circuits and has pre-tuned I.F. coils so that it is easy to align. The sound reception is high quality F.M. for complete listening pleasure. Switching arrangements are for three bands.

Number 7 kit is the perfect set for the television beginner, and it brings you better picture reception than commercial receivers of its size—and at less than one-half the price.

Tubes required: 1—6J6, 1—5U4G, 1—2X2/879, 1—6V6, 1—7X7/XXFM, 6—6SN7, 5—6AC7/1852, and one 7GP4 (seven inch picture tube). Number 7 tube kit, complete, \$42.50. Cabinet for number 7 Telekit \$24.50.

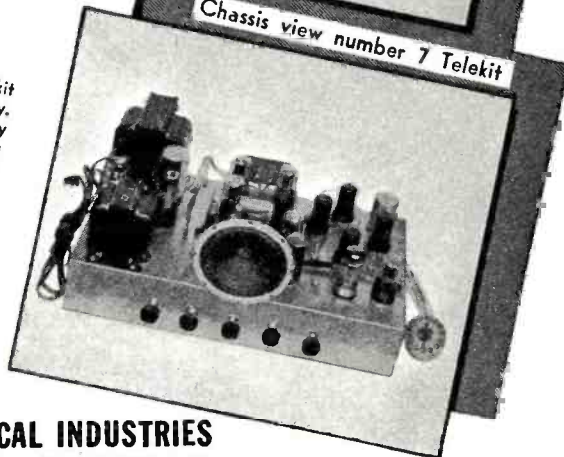

Chassis view number 7 Telekit

**TELEKIT** is a product of **ELECTRO-TECHNICAL INDUSTRIES**

121 NORTH BROAD STREET PHILADELPHIA 7, PA.

Distributed By:  
**RADIO MART, Inc.**  
 149 Riverdale Avenue  
 Yonkers, New York

RADIO MART, Inc., 149 Riverdale Ave., Yonkers, N. Y.

Gentlemen: Inclosed is 20% deposit. Please ship F.O.B. Yonkers, New York (Balance C.O.D.):

- |                                       |                                      |
|---------------------------------------|--------------------------------------|
| _____ No. 10 Telekits at \$124.50 ea. | _____ No. 7 Telekits at \$77.50 ea.  |
| _____ No. 10 Tube Kits at \$64.50 ea. | _____ No. 7 Tube Kits at \$42.50 ea. |
| _____ No. 10 Cabinets at \$29.50 ea.  | _____ No. 7 Cabinets at \$24.50 ea.  |



**Servicing Simplified** FOR AM, FM & TELEVISION  
**A MUST FOR RADIO REPAIR SHOPS**



**THE MULTI-ANALYST** solves your radio problems quickly—The easiest, most effective method of diagnosis—Saves time—wide frequency response—No frequency controls—Both audible and visual indications—Perfect for checking distortion or fading—This handsome, compact unit contains a complete, stable Vacuum Tube Volt-Ohmmeter—electronic on all ranges—Reads video voltages—Big 4½" meter—Exceptional value..... **\$89.50**

**THE MODEL 210 VTVM** is the perfect instrument for radio repair shop, laboratory, or ham shack—An accurate, stable, high impedance utility instrument with a huge 8½" no squint meter—2% overall accuracy—RF and AC measurements from 30 cycles to 300 mc—Reads to 5,000 volts DC—electronic on all ranges—Resistance measurements from .2 ohm to 1,000 megohms—Complete..... **\$65.50**

**ELECTRONIC INSTRUMENT CO., Inc.**



926 CLARKSON AVE. BROOKLYN, N. Y.

Write for FREE illustrated brochure and see your jobbers for a conclusive demonstration. Complete instruction manual with each instrument. Licensed by RCA.

**Sound Recording**  
 (Continued from page 64)

1000 cycles can be altered considerably by changing the degree of angle of incidence, that is, by rotating the frontal surface of the microphone in a horizontal plane so that impinging sound waves strike the diaphragm at an angle other than that of the usual zero degrees as formed by the arrival of sound waves from a point directly in front of the microphone. (See Fig. 6). Low frequency response is not appreciably affected by such angular changes.

By studying the cross-sectional cut-away shown in Fig. 5, one gains an insight into the extreme simplicity of construction. The microphone elements are housed in a metal shell and covered with a metal grill and silk cloth to prevent damage from foreign particles and to minimize dust collection. A metal ring which screws over the housing holds the diaphragm in place. The microphone itself consists of a circular duraluminum diaphragm to which is attached a coil of aluminum ribbon, wound in an edge-wise manner and suspended in the radial field of a cobalt steel permanent magnet. Movement of the diaphragm and its associated coil cuts the magnetic lines of force surrounding the magnet and generates an alternating output voltage which is proportional to the magnitude of the original sound waves.

An explanation of the improvement in frequency response of this microphone over that of previous types lies in the inclusion of an acoustic compensating circuit which consists mainly of a properly designed air chamber between the housing and microphone elements and an air vent tube, the length and diameter of which control the compensating action of the air chamber. These constants have been critically adjusted at the factory and should not be altered in any manner.

The output of the 618-A is approximately -84 db., and its output impedance, like that of most dynamic or pressure operated microphones, is 30 ohms.

**The Nondirectional Dynamic**

An improvement over the 618-A is the *Western Electric* 630-A, familiarly known as the "Eight-Ball" because of its sphere-shaped housing (Fig. 7).

It is well-known that any object placed in the field of either primary or reflected sound waves will cause a diffraction of those waves. When the object is a microphone, such diffraction results not only in angular distortion but, more important, causes a change of pressure of the sound waves reaching the diaphragm. The amount of pressure change is dependent not only on the angle of incidence and frequency of the approaching sound waves, but also on the physical size and shape of the microphone.

★ **SHUR** ★

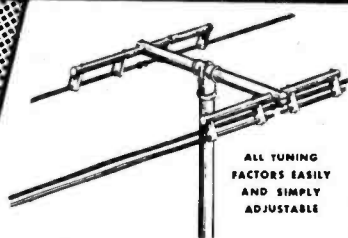

ALL TUNING FACTORS EASILY AND SIMPLY ADJUSTABLE

**NEW, IMPROVED LINE OF ANTENNAS, Featuring:—**

- Shur INTERCEPTOR and ANTENNA MOUNT
- The Shur De Luxe INTERCEPTOR
- Shur "JIFFY" line

Designed for simplicity, the "Jiffy" antenna can be assembled in seconds. Insulator units are preassembled and require only that the elements be screwed into them. Made for FM band, television band, the 6-meter band and the 2-meter band in the following models:

- JD... "Jiffy" Dipole
- J1... "Jiffy" Dipole with Director
- JFI... "Jiffy" Folded Dipole
- JID... "Jiffy" Folded Dipole with Director.

The Folded Dipole and the folded dipole side of the JID also have pre-assembled insulator units. While the rest of the Shur antennas are tunable, the "Jiffy" is fixed.

Sold through leading distributors. For further information, write to:—

**SHUR-ANTENNA-MOUNT, INC.**  
 EASTERN DIVISION SEA CLIFF, NEW YORK

**GOV'T SURPLUS**

**TUBES**

6V6—Metal.....	\$ .89
5Y3 GT.....	.45
No. 80.....	.45

Choke, Thordarson, 12H—80 MADC—250 Ohm.....	\$1.09
55 MMF FEED Through.....	20 for 1.00
.02—1600V Paper.....	10 for 1.00
.1—600V Paper.....	10 for 1.00
Resistor Kit—½ & 1 W assorted.....	2.00
Condenser Kit—.01—.00001—100.....	3.00
Bathtubs—3X .1, 5, .1 etc. 400 V & 600V.....	10 for .89
Rect. Selenium G. E. 28V, 300M.....	.50

OIL-FILLED CONDENSERS—G.E., C.D., ETC.		TRANSMITTING MICA CONDENSERS	
10	600 V \$ .80	.002	600 V \$ .08
8	600 V .70	.002	2500 V .27
8	1000 V 1.75	.003	2500 V .33
6	2000 V 2.95	.001	2500 V .18
4	600 V .50	.004	2500 V .36
4	1000 V 1.00	.00005	2500 V .11
2	1000 V .50	.005	600 V .08
.05	1000 V .30	.0005	2500 V .15
.1	2500 V .95	.002	3000 V .66
.1	7500 V 3.25	.00005	5000 V .95
.5	1000 V .20	.00025	5000 V .95
.5	2000 V .40	.00072	5000 V .95
1.	600 V .20	.0008	5000 V .95
1.	1000 V .75	.0015	5000 V .95
2.	600 V .35	KIT of 12 3.98	
3 x .2	4000 V 3.95		
3 x 10	90 V AC .40	.12	15000 V 6.95
10 x .25	600 V .20	.25	4000 V 2.75
.75	2000 V .55	.25	6000 V 4.00

\$2.00 min. order F.O.B., N. Y. C. Add postage. 50% deposit, balance C. O. D. with all orders. Manufacturers inquiries invited.

**TECHNICAL RADIO PARTS CO.**  
 265 Greenwich St. Dept. N-3, N. Y. 7, N. Y.



The New Home of  
**MELVILLE RADIO INSTITUTE**

The Melville Building is ready with facilities for over 2,000 students of

# TELEVISION & RADIO

Melville Radio Institute, a well-established, prewar school, is one of New York's outstanding vocational training centers.

Technical know-how, ample equipment and expert faculty have resulted in a satisfied student body that is among New York's largest.

Visit us today without obligation and watch the School in operation. A free brochure may be obtained by mailing the attached coupon.

Licensed by the State of New York.  
 Approved for Veterans.

### THE SIX MELVILLE COURSES

- RADIO TECHNICIAN
- TELEVISION TECHNICIAN
- RADIO COMMUNICATIONS
- RADIO & TELEVISION SERVICING
- FUNDAMENTAL RADIO MATH
- SLIP-TAPE TRANSCRIPTION

"The Radio School administered by Radio Men."

**MELVILLE RADIO INSTITUTE**  
 Melville Building  
 15 WEST 46th St., N. Y. 19 • BR 9-5080

**MAIL THIS COUPON NOW!**

**MELVILLE RADIO INSTITUTE**  
 Melville Building  
 15 West 46th St., New York 19, N. Y.  
 GENTLEMEN: Send me FREE Information about your school. RN

Name .....

Address .....

# Telephones!



**MAGNETO RINGING  
 SELF CONTAINED  
 No External Power Required**

- Simple installation - 2 wires or one wire and ground. Fence wire makes satisfactory circuit.
- Works and rings up to 50 miles.
- No external power required.
- Use as many units as you need on one pair of wires.
- Housed in rugged steel cabinet for mounting on wall or post.
- BRAND NEW French style handset.

**APPLICATIONS**

- x Broadcast remotes.
- x Construction projects - Highway - Building - Bridge Construction, etc.
- x Farm house to out-buildings.
- x Farm to farm.
- x Extension phones.
- x Store to warehouse to yard.
- x Summer camps, lodges, etc.
- x Trailer camps.
- x Athletic stadiums.
- x Independent telephone companies.
- x Ships.
- x Office intercommunicating.
- x Install your own private telephone system.

These telephones are Army surplus - slightly used, checked and inspected. Guaranteed to be in excellent condition. Dimensions - 5 1/4" x 6 1/4" x 9 1/4". Shipping weight - 16 lb.

Stock No. B-588R  
**PRICE PER UNIT**  
 Complete with  
 BRAND NEW HANDSET

**\$12.95**

*Write, wire or phone your order Today!!*

MAIL ORDERS SHIPPED WITHIN 24 HOURS  
 20% DEPOSIT REQUIRED

All prices are net, f.o.b. Dayton, O.

**SREPCO**

STANDARD RADIO & ELECTRONIC PRODUCTS CO.  
 135 E. Second St. - DAYTON 2, OHIO. - Tel. FULTON 2174  
 Cable Address "SREPCO"

PLEASE  
TEAR OUT THIS AD  
AS A REMINDER

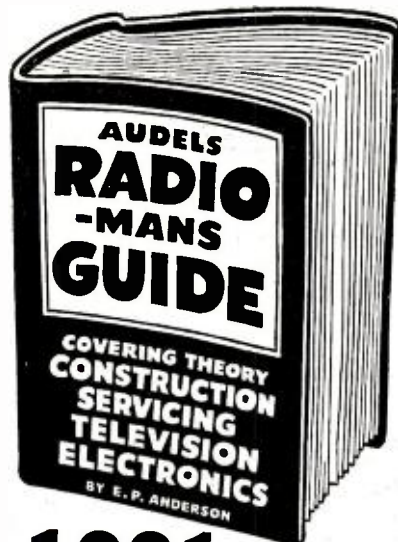

**1001 RADIO FACTS AND FIGURES**

AUDELS RADIOMANS GUIDE—914 Pages, 633 Illustrations, Photos, Wiring Diagrams, 38 Big Chapters, covering Radio Theory, Construction, Servicing, including Important Data on Developments in Television, Electronics and Frequency Modulation, Review, Questions and Answers, Calculations & Testing. Highly Endorsed—Indispensable for Ready Reference and Home Study.

**\$4 COMPLETE • PAY ONLY \$1 A MONTH**  
Step up your own skill with the facts and figures of your trade. Audels Mechanics Guides contain Practical Inside Trade Information in a handy form. Fully illustrated and Easy to Understand. Highly Endorsed. Check the book you want for 7 days' Free Examination.

Send No Money. Nothing to pay postman.

**CUT HERE**  
**MAIL ORDER**

AUDEL, Publishers, 49 W. 23 St., New York 10, N. Y.

Please send me postpaid for FREE EXAMINATION books marked (x) below. If I decide to keep them I agree to mail \$1 in 7 Days on each book ordered and further mail \$1 monthly on each book until I have paid price. Otherwise, I will return them.

- RADIOMANS GUIDE, 914 Pages . . . \$4.
- ELECTRICIANS EXAMINATIONS, 250 Pages . . . 1.
- WIRING DIAGRAMS, 210 Pages . . . 1.
- ELECTRICAL DICTIONARY, 9000 Terms . . . 2.
- ELECTRICAL POWER CALCULATIONS, 425 Pgs. . . 2.
- HANDY BOOK OF ELECTRICITY, 1340 Pages . . . 4.
- ELECTRONIC DEVICES, 216 Pages . . . 2.
- ELECTRIC LIBRARY, 12 vol., 7000 Pgs., \$1.50 vol. . . 2.
- OIL BURNER GUIDE, 384 Pages . . . 1.
- REFRIGERATION & Air Conditioning, 1280 Pgs. . . 4.
- POWER PLANT ENGINEERS Guide, 1500 Pages. . . 4.
- PUMPS, Hydraulics & Air Compressors, 1658 Pgs. . . 4.
- WELDERS GUIDE, 400 Pages . . . 1.
- BLUE PRINT READING, 416 Pages . . . 2.
- SHEET METAL WORKERS Handy Book, 388 Pgs. . . 1.
- SHEET METAL PATTERN LAYOUTS, 1100 Pgs. . . 4.
- AIRCRAFT WORKER, 240 Pages . . . 1.
- MATHEMATICS & CALCULATIONS, 700 Pgs. . . 2.
- MACHINISTS Handy Book, 1600 Pages . . . 4.
- MECHANICAL Dictionary, 968 Pages . . . 4.
- AUTOMOBILE GUIDE, 1540 Pages . . . 4.
- DIESEL ENGINE MANUAL, 400 Pages . . . 2.
- MARINE ENGINEERS Handy Book, 1280 Pages . . . 4.
- SHIPFITTERS Handy Book, 272 Pages . . . 1.
- MECHANICAL DRAWING COURSE, 160 Pages . . . 1.
- MECHANICAL DRAWING & DESIGN, 480 Pgs. . . 2.
- MILLWRIGHTS & Mechanics Guide, 1200 Pgs. . . 4.
- CARPENTERS & Builders Guides (4 vols.) . . . 6.
- PLUMBERS & Steamfitters Guides (4 vols.) . . . 6.
- MASONS & Builders Guides (4 vols.) . . . 6.
- MASTER PAINTER & DECORATOR, 320 Pgs. . . 2.
- GARDENERS & GROWERS GUIDES (4 vols.) . . . 6.
- ENGINEERS and Mechanics Guides . . . 12.
- Nos. 1, 2, 3, 4, 5, 6, 7 and 8 complete . . . 12.
- Answers on Practical ENGINEERING . . . 1.
- ENGINEERS & FIREMANS EXAMINATIONS . . . 1.

Name \_\_\_\_\_  
Address \_\_\_\_\_  
Occupation \_\_\_\_\_  
Employed by \_\_\_\_\_ **RN**

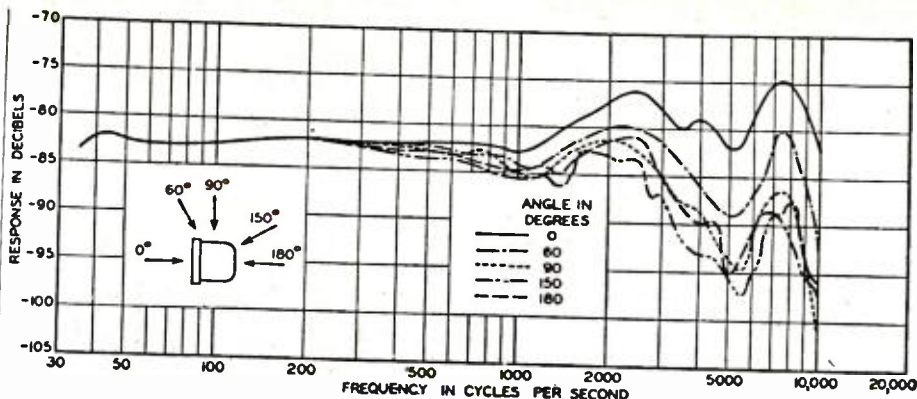

Fig. 6. Angular response of moving coil microphone.

Because of a tendency to discriminate between various angles of wave frequencies above 1000 cycles, the microphone assumes a directional characteristic whose factor does not maintain a fixed value, but rather varies in accordance with changes in both the frequency and in the angle of incidence of the impinging sound waves. This action gives rise to phase distortion in the output of the microphone. Since the over-all size of the microphone is one of the basic factors involved, it is assumed that this problem could be solved by decreasing the physical dimensions of the housing and microphone elements. However, theoretically, a microphone so constructed as to present no angular discrimination over the normal audio frequency range would be impractical because of its extremely small size, delicate construction, and inherent loss of output. Such a unit would require that an additional preamplifier be used. It, therefore, holds that the shape of the housing, which is another basic factor, is the solution to this particular problem.

Tests made by engineers of the *Bell Telephone Laboratories* on the effects of various shaped objects on sound wave diffraction, produced conclusive data which resulted in the selection of the spherical-shaped housing as the best suited in reducing directional distortion. Referring to the cross-sectional diagram in Fig. 7 it can be seen that the microphone is divided into

two parts, with the microphone itself, comprised of diaphragm, coil, magnet, and acoustic resistance, in the top of the shell. The lower half, whose bottom section is recessed to hold the connecting terminal plug, contains an air chamber and equalizing tube. This rubber tube, cut to its proper length at the factory, is used to increase the low frequency response and to compensate for differences in air pressures inside and outside the shell. The two halves are separated by an acoustic-resistance baffle, which essentially is a flat metal plate perforated by six one-half inch holes to provide acoustic continuity between both sections of the housing. This baffle is used to prevent the occurrence of cavity resonance within the housing itself.

Ordinarily a microphone having its diaphragm mounted in a horizontal plane and normally facing upwards, exerts a marked tendency toward giving better frequency response to high-frequency waves reaching the diaphragm from various angles above the horizontal plane than for corresponding waves reaching it from below. This condition was overcome by the employment of an acoustic screen. This screen, two and one-half inches in diameter and surrounded by a protective metal ring, is composed of a wire mesh screening on either side of several layers of treated silk cloth, and mounted horizontally about one-eighth inch above the front of the diaphragm. By virtue of its resistance to

Fig. 7. The familiar Western Electric "Eight-Ball" microphone.

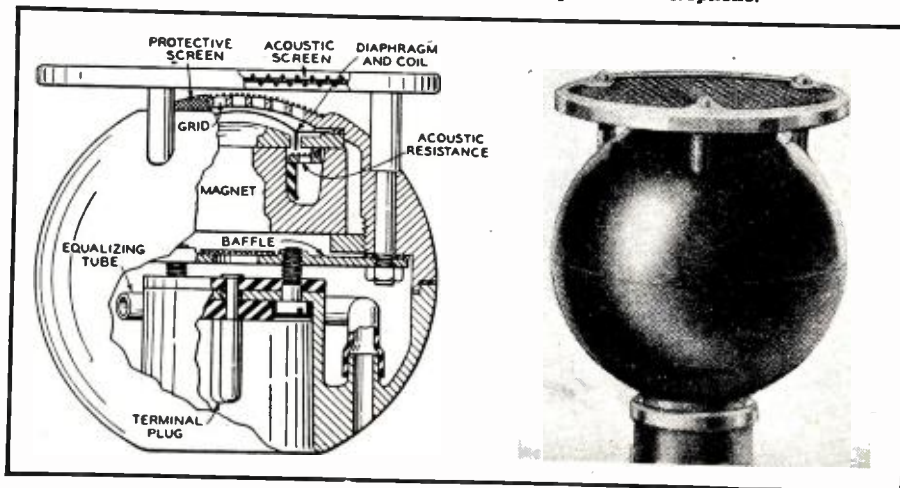



# Bargain ASSORTMENTS

★ ★ ★ ★ ★ ★ ★ ★

A GOLDEN OPPORTUNITY TO STOCK UP—AT A BIG SAVING—ON DOZENS OF ITEMS YOU NEED—SATISFACTION GUARANTEED—ORDER BY NUMBER

**NO. 1—DRIVE PULLEYS**  
For Variable Condensers and Drive Cables—From 3/4" to 2 1/4" diameter ..... 30 for \$1.95

**NO. 2—STEEL CHASSIS**  
"Builders' Delight"—All are drilled—ready to use—From midget chassis to large Scope and power supply chassis. A rare bargain at ..... 10 for \$3.95

**NO. 3—XTAL PHONOGRAPH PICK-UP ARMS**  
Complete with Crystals. STANDARD BRAND—Latest Styles & fresh stock—Some List for \$10.00 or more!! A SURPRISE "BUY"!! You would never pass this one if you saw it!!! ..... 3 for \$7.95

**NO. 5—BALLAST TUBES**  
Assorted as you would select them yourself!!—L49B, etc. and some UNIVERSALS, TOO!!! ..... 12 for \$3.95

**NO. 6—PHONOGRAPH MOTOR and PORTABLE CABINET**  
A High Grade, Standard Brand Motor & Turntable, ready to mount in this beautiful leatherette covered portable cabinet!! TRY ONE—You will holler for more!! ..... 2 Pieces for \$9.95

**NO. 7—COIL FORMS**  
2" & 3" diameter—Bakelite and Ceramic—For Ham coil forms—crystal sets, etc. .... 12 for \$1.00

**NO. 9—BY PASS CONDENSERS SPRAGUE-OIL FILLED**  
The finest made!!! 600 WV Rating—This high grade style construction is ordinarily too high priced for use in regular repair work. We offer them here just at an extremely low price. Sizes are .004, .005, .006, .009, .01, .025, .05 ..... 50 for \$4.50; 100 for \$7.95

**NO. 10—MONEY MAKER SPECIAL**  
15 Dial scales—8 pyralin windows—5 Beautiful metal rim Window & escutcheons—4 ass'd. dial glasses. .... 30 Pieces for \$2.95

**NO. 12—FUSES**  
1/2 amp to 20 amp fuses—type 3AG—50 assorted in a glass jar ..... 50 for \$9.50

**NO. 13—RIVETS ALUMINUM**  
This one-pound lot contains a million rivets!!! Don't be without them!! ..... 1 lb. for 75c

**NO. 15—METAL SPACERS**  
1/2" & 3/4" diameter—1/4" to 1 1/2" long. Ideal for raising sub panels, etc. .... 100 for 95c

**NO. 16—5 LB. ASSORTED HARDWARE**  
A grand assortment of those hardware pieces you reach for every day!!! All small pieces—nuts, bolts, washers, for every day!!! ..... 5 lbs. for \$2.45 sheet metal screws, etc.

**NO. 17—BINDING POSTS**  
Here is a chance to STEAL some high grade binding posts! Some of these List for as much as a dollar each!! We can supply additional quantities of any you get in the assortment. The assortment is put up in pairs. .... 30 Posts for \$1.95

**NO. 18—BAND SWITCHES**  
This assortment of 25 Band Switches is an outstanding value!! Many are ceramic—All are high priced switches. Multiple deck types, multiple position, etc., etc. A steal at ..... 25 for \$3.75

**NO. 19—TRIMMER CONS**  
Who Ever Heard of a Money-Making-Saving Bargain Like This!!! ..... 50 for \$2.95

**NO. 20—1/2-1 WATT RESISTORS**  
A "Best Buy" Any day!!! Made up of Better resistors. AND a Good and Complete range of needed and usable values. No Junk in this!! All New and RMA Coded. .... 100 for \$2.45

**NO. 21—WIRE WOUND RESISTORS**  
A "SUPER SAVING" BARGAIN!!! 5, 10, 20, 25 & 50 WATT—MOST OF THESE SELL REGULARLY FROM 25c on up to \$1.00 or more. ALL STANDARD BRANDS AND SIZES. BEST BUY ON THIS PAGE. .... 50 for \$3.45

**NO. 22—SET SCREW KNOBS**  
A "BETTER" Knob assortment—Beautiful brown bakelite. All for 1/4" shafts. As YOU would select them!! ..... 50 for \$3.75

**NO. 25—VIBRATORS**  
An "OLD TIME" Bargain!! Its been years since we could offer a really great buy like this!! We are genuinely proud of it!!—Standard Brands—4, 6, & 7 prong—Sync. & Non-Sync. .... 6 for \$7.95; 10 for \$12.50

**NO. 26—TUBES**  
Who Would Have Thought You Could Buy Standard Brand, New Tubes Today AT THESE PRICES!! You get one of Each of These 17 types PLUS ANY 3 ADDITIONAL ONES YOU SELECT FROM THIS LIST!! ..... 20 for \$7.50  
5Y3GT, 1R5, 6SH7, 12SR7, 6SN7, 12SN7, 11A, 1S5, 6SK7, 6SQ7, 17A, 354, 9005, 12SG7, 6G6G, 1633.

**NO. 34—SPAGHETTI**  
100 Ft. Assorted sizes and Colors Varinshed Cambrle and Vinylite tubing—"Gotta Have One" assortment!! ..... 100 ft. for \$1.75

**NO. 35—ELECTROLYTIC CONDENSERS**  
Here's a Wonderful "OLD TIME" Bargain in Guaranteed Condensers!! These 20 condensers are all in Metal Cans & Mostly of the Popular P. Type. Some are multiple section units—Some are 600 WORKING VOLTAGE!! You will wish you had bought more than one of these assortments!!!! ..... 20 for \$4.75

**NO. 36—A.C. D.C. CORDS**  
Here's a \$2.00 or more saving!! Ten resistor cords for AC-DC Radios—Sizes from 135 ohm to 590 ohm. AND includes at least One Universal Tapped Cord!!! ..... 10 for \$4.25

**NO. 40—AUTO AERIALS**  
TAKE A CHANCE WITH US ON THIS "GREATEST OF ALL" S P O C K REDUCING BARGAIN—MONEY MAKING ASSORTMENT OF 12 C.O.M. PLETE, N D I D U A L L Y BOXED CAR AERIALS!!! ALL STANDARD M A K E S AND HIGHEST QUALITY—RETAIL PRICE TOTALS OVER \$60.00!!! ..... 12 for \$24.00

**NO. 39—SPEAKER FIELDS**  
This lot is a sweet buy—2 new speaker fields—Some for 4", 5", 6", 7", 8", 9", 10" & 12" speakers—At this very low price, they provide cheap magnet wire for the shop—Order two or three of these assortments!!! ..... 12 for \$2.75

# QUALITY BARGAINS FOR THE SERVICE MAN

ORDER ANY AND ALL YOUR RADIO NEEDS FROM CRABTREE'S!! Complete Stock of Standard Brand AND Surplus Electronic Parts & Equipment

**Single Conductor Stranded Wire**  
Heavy Current Carrying Capacity—  
#6 Braided Vinylite Covering—outside diameter 5/16" ..... per ft. \$0.07  
#8 Braided Vinylite Covering—outside diameter 1/4" ..... per ft. .05

**Three Conductor Inter-Com. Cable**  
STRANDED #22 WIRE  
Rubber Covered—1/4" OD  
Per 100 ft. ... \$ 2.20 Per 100 ft. ... \$ 4.00  
Per 1000 ft. ... 20.00 Per 1000 ft. ... 38.00

**Universal AC-DC Resistance Line Cord**  
Replaces AC-DC cords from 12 ohms to 330 ohms. Can be used either for standard three terminal or taped cord. List price \$1.72. Regular price is \$1.03. Your cost Each ..... \$0.89  
Individually Boxed, In Lots of 10—Each ..... .59

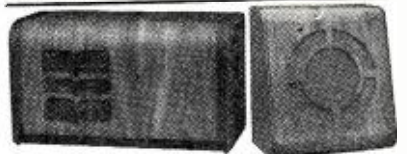

When you unpack your shipment of these cabinets you will be agreeably surprised to find that Beautiful, Well Made, Prewar types of Construction, Woods, and Piano Finish, are still available—and at Reasonable Prices. These table Models and Speaker Baffles compare favorably with FINE FURNITURE. Do not confuse them with many current offerings of "cheap" cabinets. These cabinets are genuinely beautiful—Satisfaction Guaranteed!!

**REPLACEMENT CABINETS** are Rolled front—Front panel of walnut veneer—Ends of solid hardwood—highly finished—Front panels have soft core for easy cutting and fitting.  
**DELUXE SPEAKER BAFFLES**—for all general indoor work. A beauty—heavily constructed, gracefully rolled, genuine walnut veneer front panel. Highly finished, and scientifically designed to give maximum frequency response. The trapezoidal design gives proper directional effect when mounted near wall or on floor. Ends of solid hardwood. Made in 5 sizes to meet all requirements.  
Model 44A—For chassis 9 1/2" x 5" Your Net each \$3.23 Each in lots of 6 3.00

Model 44B—For chassis 13 1/2" x 8 1/2" x 8" Each 4.32 Each Net 3.09

No. 5—For 5-inch Speaker ..... Each Net 3.09  
Size 6 1/2" High, 7 1/2" Deep

No. 6—For 6-inch Speaker ..... Each Net 3.09  
Size 8 1/2" High, 11" Deep

No. 8—For 8-inch Speaker, List price, 5.73  
Size 11 1/2" High, 11" Deep

Model 10—For 10-inch Speaker, List price, 6.17  
Size 14" High, 12 1/2" Deep

Model 12—For 12-inch Speaker, List price, 6.17  
Size 18" High, 15" Deep

**Amplifier and Speaker Case**  
Sturdy Wood Case—Finished in "Airplane" leatherette, with strong carrying handles, and good hardware. A great Value At These Prices—  
DUAL CASE for amplifier and 10" or 12" speaker in each half—20" x 10" x 14 1/2" Weight 5 lbs.  
SINGLE SPEAKER CASE for amplifier and one 10" or 12" speaker, 18 1/2" x 15" x 10". Dual Case—\$7.95. Single Case—\$6.95.

**Let's Get On The Ball—With Complete, Up to the Minute Service Data!!! Do It Today—Order Your Rider's Volume Fifteen And Sixteen OR Your Howard W. Sams Volumes I & II. Being without these great service helps, costs you time and money EVERY DAY!!!**

Volume I ..... Postpaid \$18.39 Net Issued Dec. 30, 1946 (Folios 1-10)—1946 Sets.

Volume II ..... Postpaid \$18.39 Net Issued June 30, 1947 (Folios 11-21)—1947 Sets. Don't wait for the complete Volume III (Folios 21-30)—to be issued Dec. 30, 1947. Let us send you each of the next ten folios—Numbers 21 to 30, inclusive—as they are released.

**BARGAIN OPPORTUNITY!!**  
Send us \$15.00 as advance payment on Folios Nos. 21 thru 30 (Folios of Volume III)—and we will automatically send them to you postage prepaid. Get your extra binder now for Volume III. Holds 10 or more folios. .... \$3.99 Net

**Massco Deluxe 25 Watt Amplifier Model MA-25P**

An "All Round" Practical & Popular Amplifier for All types of uses—Inexpensive—dependable 25 Watt output: 110 V. A.C. Two mike & one phono input.

This "Top Utility" amplifier for your average amplifier needs, costs you—with tubes, \$62.23 Speakers, Mike, etc., are extra—tell us what you would like to have & we will make up a complete operating system for you—Jensen, Atlas, University speaker—Electro Voice, Astatic, Sh u p e, etc., microphones.



# QUALITY BARGAINS FOR THE HAM

A Dependable Source for ALL Your HAM Needs Standard Brands AND Surplus Build This 10 Meter Fixed or Mobile Converter As Your Next Project!

Go "Mobile" with this converter, working into your regular car receiver—  
—Uses 6X8 & VR-150.  
—Requires only 6.3 V. at .3 amps, and 180 V. "B" supply.  
—1500 KC output.  
—Antenna change over switch.  
—Planetary drive tuning ... Band spread over approx. 65 degrees.  
—Oscillator voltage regulated for stable operation. Use it with your regular communications receiver for improved performance—Gives you "preslector" performance plus improved image rejection.  
Small size—Only 7" wide, 4 1/2" deep, 4 1/2" high. Easily fits into most glove compartments.

**KIT OF PARTS, COMPLETE WITH TUBES, CHASSIS, PANEL, & CABINET. \$18.95**  
Diagram & detailed instruction sheet included.



## SURPLUS POWER UNIT

6 or 12 Volt input—150 Volts—50 mill Output  
Knick wrinkle finish, steel carrying case. Size 15" x 12" x 4 1/2". Approx. 35 lbs. in weight. Comes to you complete with voltage regulator tube, rectifier tube, prong vibrator, and plug in type electrolytic condenser—ready to operate. Just The Thing For Mobile P. A. Systems, Transmitters, Farm Sets, Test Benches, and many Other Uses!!!  
Power Unit can be taken out of steel carrying case, making a very compact unit. Originally cost about \$100.00.

Two of these units may be operated in series to supply 300 Volts @ 50 mills.  
A Bargain Buy—While They last ..... \$7.95

**Code Key**  
Portable OR Table Mount!  
Completely enclosed in black wrinkle finish metal case, with leg straps for field work. Overall dimensions 5 1/2" long, 2" high, 2" wide. Complete with 3 ft. cable and PL-55 two-circuit plug. .... \$0.98

**SINGLE BUTTON Telephone Mike**  
A single button, 200 ohm Carbon Mike, mounted in a telephone desk stand. "PUSH TO TALK" hand switch for thumb control. The mike works into 200 ohm imped. Mike trans. Complete With 6 ft. rubber cord & a 2 circuit plug. .... \$4.95

**15 Henry Choke**  
15 Henry-250 mil. D.C. 90 ohms. Black wrinkle finish. Rectangular case 4" x 4" x 3 1/2". A QUALITY BARGAIN ..... \$2.95

**5 H. Swinging Choke**  
5 Henry, 175 mil. D.C. 60 ohms. Round case—smooth telephone blk. finish. 3 3/4" x 4 1/2". \$3.45

**12 Henry Choke**  
12 Henry, 100 mil. D.C. 280 ohm. Round case—3" x 4"—smooth telephone grey ..... \$2.00

**Modulation Transformer**  
P.P. 6L6 Class "AB"—6000 ohm C.T. primary, 150 mil. Sec.—2000 ohm, 100 mil. White porcelain insulators. 4" x 4 3/4" x 4 1/2". Only a few at ..... \$4.39

**Plate Transformer**  
115-230 V. Primary. Open-frame type, with porcelain insulators. Secondary 1170 V. AC C.T. 600 Mills. Measures 6" high x 6" x 6 3/4". Weight 23 lbs. Only a few @ ..... \$8.95

**Filament Transformer**  
W. E. Open frame—1/2" air gap. 20,000 Volt insulation. 5 Volts C. T. 25 amps. 110 Volt tapped primary ..... \$3.95  
Tell Us What Transformers You Need—We Probably Have It In Stock!  
—In Surplus, or Stancor, or Thordarson—Hermetically sealed metal case, and oil filled paper condensers. Made by the leading manufacturers to meet the highest standards. These were all built for long, rugged, dependable service under exacting conditions. Order These Real Values Today!!!

1 x 2000 Volt Sprague ..... \$0.95  
25 x 3000 " Sprague ..... 1.75  
5 x 2000 " Sprague ..... 1.45  
1 x 1000 " Cornell ..... 2.45  
1 x 2000 " Westinghouse ..... 2.45  
1 x 3000 " Industrial ..... 3.25  
1 x 4000 " Cornell ..... 3.25  
1.5 x 1500 " Industrial ..... 2.95  
2 x 800 " GE ..... 1.95  
2 x 1000 " Industrial ..... 2.45  
2 x 4000 " GE ..... 4.95  
3 x 4000 " Industrial ..... 5.45  
3 x 3000 " Sprague ..... 3.95  
4 x 600 " Cornell ..... .75  
4 x 600 " Cornell Round ..... .75  
6 x 600 " Sprague ..... 1.95

8 x 600 Volt Sprague Round ..... 1.69  
8 x 1000 Volt Indus. trial ..... 3.95

2608 ROSS AVE. DALLAS TEXAS

**CRABTREE'S**  
WHOLESALE RADIO

**TERMS**  
Send 20% Deposit—Balance C. O. D. E. B. Dallas, Tex. Any unused portion of your deposit will be refunded immediately unless you instruct us otherwise.  
All Merchandise guaranteed. All Mises offered subject to prior sale.

**RADIOMEN!  
ELECTRICIANS!**

240 Page BOOK on "HOW TO  
START A SHOP  
OF YOUR OWN"

**FREE**

Here's an unusual "get acquainted" offer! This new 1947 book, "Starting & Operating a Profitable Electrical or Radio Business" is yours, absolutely FREE! It tells how to start and run a paying service shop right, on small capital, full or part time. Packed with practical information to help you get ahead in a shop of your own or working for some one else.

**10 to 1 Satisfaction  
GUARANTEE**

"I personally guarantee that at the end of 1 year from date of receipt, my "Applied Practical Radio" set will have earned for you at least 10 times its cost, or you may return it and I'll return every cent you paid."

B. W. Cooke,  
Pres.

**HOW TO GET  
YOUR FREE BOOK**

You get this book Free just for looking over—without cost or obligation—the sensational new 3-volume Coyne set "APPLIED PRACTICAL RADIO". It's just off the press. Here's everything you want to know about radio, from basic principles to up-to-the-minute Television and FM! PA, short-wave, aviation-auto radio, multi-bands, tele-transmission, etc., all clearly explained. Shows how to construct, install, service all types of apparatus. Step-by-step photos break equipment down before your eyes! Newest testing methods. Hundreds of subjects, almost 1000 pages, 600 illustrations, diagrams. Written for home training and field reference—so complete, so up-to-date and practical that every man interested in radio should see it.

**SEND NO MONEY!** You can see how much this Set can mean to your future, without cost or obligation. I'll send "APPLIED PRACTICAL RADIO" postpaid, for you to look over for 7 days FREE—and with it, the "Business Starting" book as an outright Gift! This book is yours to keep free whether or not you decide to keep the 3-volume set!

Coupon is Not an Order  
Just a Request to  
See the Set Free

You are not buying the 3-volume set when you send this coupon. You are merely asking to see the books free for 7 days. This coupon becomes an order only if you decide to keep the set after 7 days Free Examination. Free Book Offer is limited—so mail coupon today.

**JUST OFF  
THE PRESS**

**FREE BOOK COUPON**

B. W. Cooke, Pres., COYNE ELECTRICAL SCHOOL,  
Dept. 67-T3, 500 S. Paulina Street, Chicago 12, Illinois.

Send me the NEW 3-Volume Coyne Set, "APPLIED PRACTICAL RADIO". Also send me the book, "Starting & Operating a Profitable Radio or Electrical Business", which I am to keep FREE whether or not I keep the 3-book set. I'll either return the 3-book set in 7 days and owe nothing, or pay \$3 within 7 days and \$3 a month until \$10.75 is paid—or I'll send the cash price of \$9.75. You also include FREE one full year of Consultation Service.

NAME \_\_\_\_\_ AGE \_\_\_\_\_

ADDRESS \_\_\_\_\_

TOWN \_\_\_\_\_ ZONE \_\_\_\_\_ STATE \_\_\_\_\_

Check here if you want to pay postman cash price of \$9.75 (you save \$1.00) on delivery. Same Money-Back Guarantee after 7 days' trial.

sound waves, the screen tends to reflect waves coming from below the horizontal plane back into the diaphragm, thereby lending valuable sound reinforcement, and also acts to retard sound waves striking the screen from the front. The microphone response to varying degrees of angular sound approach is thereby made uniform.

The diaphragm is mounted as close to the front of the shell as is possible, a feature which is desirable in that the total angle of diffraction formed by the spacing between housing and diaphragm is reduced to a negligible degree, and at the same time a larger area is permitted in the air chamber behind the diaphragm. The useful amount of back-pressure thus formed is an important factor in the reduction of diaphragm vibration impedance. Protection of the diaphragm is afforded by a grid which is so designed as to offer added improvement in high-frequency response. Covering this grid is a screen of silk cloth which protects the diaphragm from possible damage from iron filings, dust particles, and other foreign matter.

Frequency response of this microphone is essentially flat from 40 to 10,000 cycles, without regard to angle of incidence.

Output of the 630-A is approximately -87db., or 3 db. below that of the 618-A, but this slight disadvantage is more than offset by its improved frequency response, lighter weight, compactness, and adaptability to a wider variety of uses.

**The Velocity Microphone**

The "velocity" type of microphone is so called because its action depends on the velocity of air particles rather than sound wave pressure. It is also known as a "pressure-gradient" unit, and more familiarly as a "ribbon."

The design of velocity or "pressure-gradient" units is represented in the

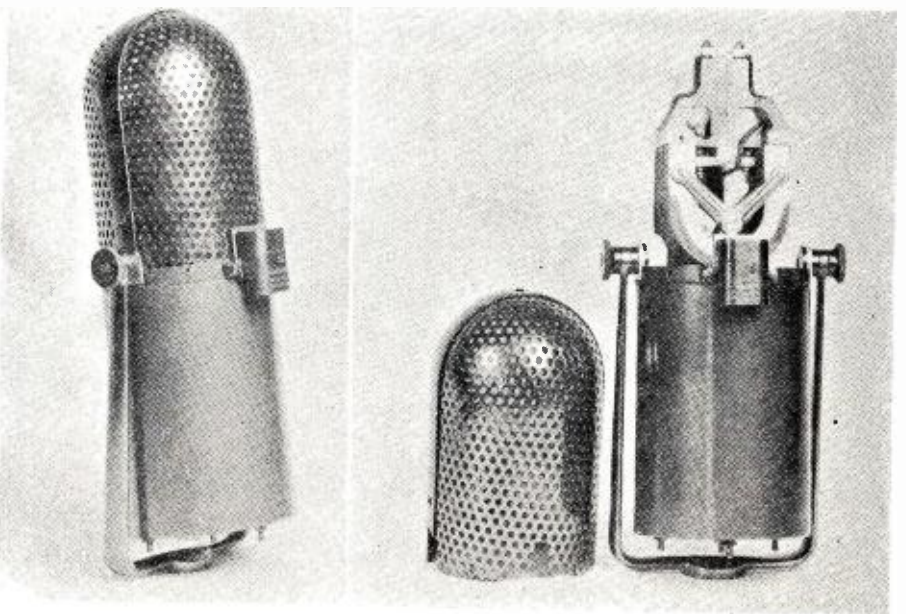

Fig. 8. The velocity microphone which is also known as a "ribbon type."

development of the RCA 44-BX. With a uniform frequency response from 40 to over 10,000 cycles and an output level of -55 db., at a reference level of .001 watt, the 44-BX approaches the criterion in the combination of efficiency, sensitivity, shock resistance and streamlined ruggedness.

Construction of the 44-BX lies along conventional lines and is shown in Fig. 8. A thin corrugated aluminum ribbon, so designed and constructed that its natural resonant point falls below the lower limits of the audio frequency range, is suspended between the poles of two paralleled sections of a cobalt permanent magnet. As the length of the ribbon is perpendicular with respect to the plane of the magnetic lines of force and its width coincident with that plane, it follows that any movement of the ribbon in response to the pressure-gradient of impinging sound waves will cause the magnetic

Fig. 9. The RCA Model 77-A (left) and Model 77-D (right).



An Answer to Your Needs!

# RADIO TEST INSTRUMENTS

by Rufus P. Turner

Consulting Engineer, RADIO NEWS

**TELLS HOW TO CONSTRUCT, CALIBRATE, AND USE ELECTRONIC AND RADIO TEST EQUIPMENT**

This well illustrated and practical manual will be an asset to any radio man's service library. It shows how to build, how to properly calibrate, how to use dozens of different types of radio and electronic testing devices. It covers briefly the theoretical explanation of radio, but only to make sure the reader first understands electrical and radio theory. The major portion of the book is devoted to technical data, which is presented in clear, understandable language. An ideal text for the practical radio man and a *must* for the radio serviceman.

### Graphically Illustrated

Included are 182 informative illustrations—diagrams, charts, tables, and photographs—carefully chosen by the author to illustrate his sixteen chapters. RADIO TEST INSTRUMENTS is a unique presentation of a culmination of the author's own practices and applications. He has constructed and calibrated, tested and built, each piece of equipment described. And he shows how you can build and use these test instruments.

### Covers Fully All These Test Instruments

- Multipliers
- Resistors
- Multi-Range Voltmeters
- Multi-Range Ammeters
- Ohmmeters
- Ultra-High-Resistance Meg-ohmmeters
- Volt-Ohm-Milliammeters
- Wattmeters
- Vacuum-Tube Voltmeters
- Decibel Meters
- Bridge-Type Impedance Meters
- Direct-Reading Impedance Meters
- Simple Capacitor Checkers
- Compact Capacitor Checkers
- Simple Coil Checkers
- Substitution-Type Capacitance Checkers
- Resonant Inductometers
- Precision Resistance Bridge
- High-Gain Null Detectors
- Oscilloscopes
- R.F. Test Oscillators
- and many others

**Price \$4.50. Use convenient coupon with full return privilege**

**ZIFF-DAVIS PUBLISHING COMPANY**  
185 North Wabash Avenue, Chicago 1, Ill.

September, 1947

REVISED EDITION  
NOW AVAILABLE!

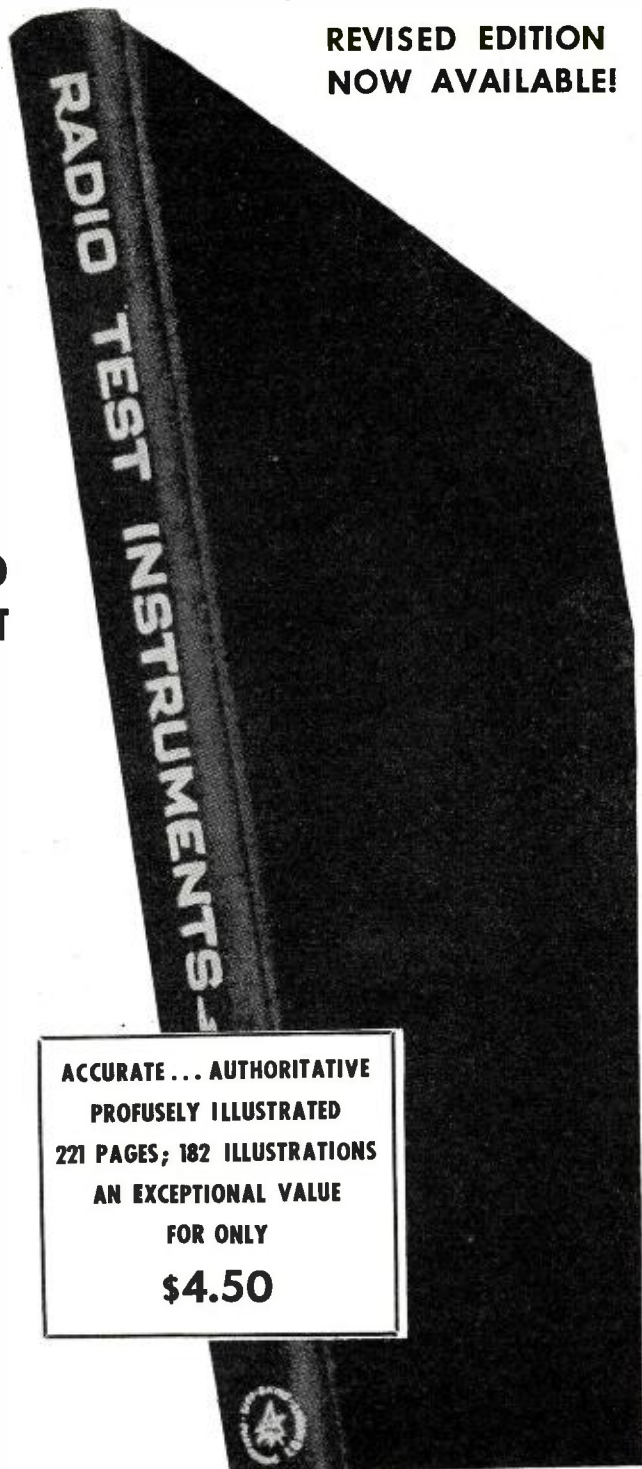

**ACCURATE... AUTHORITATIVE**  
**PROFUSELY ILLUSTRATED**  
**221 PAGES; 182 ILLUSTRATIONS**  
**AN EXCEPTIONAL VALUE**  
**FOR ONLY**  
**\$4.50**

**MAIL THIS COUPON TODAY**

Ziff-Davis Publishing Company, Dept. RN-8  
185 North Wabash Ave., Chicago 1, Ill.

I am enclosing \$4.50 (check or money order) for which please send me one copy of RADIO TEST INSTRUMENTS. I understand that I may return book within five days for full refund if I am not entirely pleased.

Name .....

Address .....

City ..... State.....

# 4 TREMENDOUS VALUES PROFESSIONALLY DESIGNED RADIO KITS



**Kit Model FM-7, a splendid, low-priced, self-contained table model Frequency Modulated Radio Receiver Kit** Complete with tubes, speaker and beautiful Bakelite cabinet. The FM-7 has a frequency response of 86-110 MC. can also be used as a tuner with a high quality amplifier. A phonojack is provided in the rear of the chassis with double pole, double throw switch control for feeding signal to either the radio speaker or to the phonojack. An additional jack for connecting extra loud speaker is included. The R.F. section of kit is pretuned at factory. This kit uses 2 I.F. stages, 1 limiter stage and 1 discriminator. Miniature tubes used throughout. Price of Model FM-7 complete as described....\$29.95

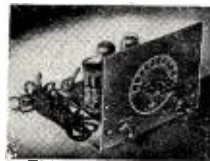

**Kit Model R-3, a 3-tube receiver of the regenerative type**

This receiver is the 110 volt type and operates at a frequency of 550 Kc to 1500 Kc by means of a plug-in coil. The power supply is self-contained in the receiver thus eliminating the need for a separate power pack. Price of Model R-3, less tubes..\$6.00



**Kit Model S-5 uses the universally accepted super-heterodyne circuit**

Containing the following tubes: 12SA7, 12SK7, 12SQ7, 50L6, 35Z5 and tubes from 550 Kc to 1600 Kc. Price of Model S-5, less tubes.....\$10.95



**Kit Model 210, a Three Way Portable Receiver** Operating on either AC or DC or self-contained batteries... power switch conveniently located on front of set so that "battery" or "AC-DC" may be selected without opening case. Five-inch Alnico 5 permanent magnet dynamic speaker, and case covered with weather tested aircraft material. Price of Model 210, complete with tubes.....\$18.95

All kits accompanied by a detailed, illustrated instruction sheet. Many other kit models available, write for catalog K.

**RADIO KITS COMPANY 120 CEDAR STREET NEW YORK 6, N. Y.**

## SENSATIONAL SELLER!



### LAKE DELUXE CHANGER

Revolutionizes the Industry!  
A Sensational Seller!

#### 11 Outstanding Features:

- Positive Intermix
- Service Adjustments Eliminated
- Minimizes Record Wear
- Single Knob Control
- Plays ALL Records
- Pick-up arm may be grasped at any time and changer will not be thrown out of adjustment
- Resonance-free ball bearing tone arm
- Easily operated—any child can do it
- Completely Jam-proof
- Records Gently Lowered on Spindle—not dropped
- Automatic Shut-off on last record

Dimensions: 13 1/8" W x 12 1/4" D x 7 3/4" H. No. 116A... YOUR NET **\$28.73**

**SERVICEMEN—RETAILERS**  
Write for our new, illustrated 16-page catalog NR-116 It's free. Get on our mailing list! Write for our Special Catalog on Microphones, Amplifiers and Sound Equipment!

**Lake Radio Sales Co.**  
615 W. Randolph Street  
DEPT. A  
Chicago 6, Ill.

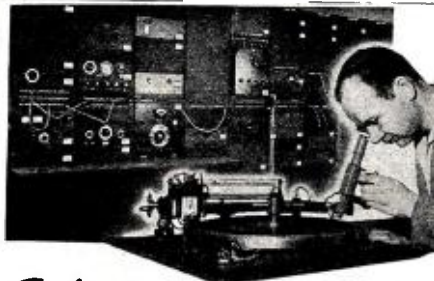

## School of SOUND RECORDING and TRANSMISSION ENGINEERING

Learn sound recording and transmission engineering techniques of the professionals, as used in Motion Picture, Broadcast, F-M, Television, and Commercial Recording Studios.

A nine months practical engineering course, devoted exclusively to the technique of sound recording and transmission measurements. Well equipped studios, professional recorders and circuit laboratory containing latest model test equipment installed for student training. A portion of our laboratory is pictured above.

• New classes admitted the first School day of Jan., Apr., July, Oct.  
*H.M. Tremaine*  
Director  
Affiliated with the Don Martin School of Radio Arts  
Approved for Veterans



Write for Literature • Sound Department  
*Don Martin* SCHOOL of RADIO ARTS  
1655 Cherokee • Hollywood 28, California

lines of force to be cut in a transverse manner. By virtue of its extreme lightness and sub-audible resonant period, the ribbon allows uniform response over the entire audio frequency range without undue frequency discrimination or tendency toward cavity resonance effects. As a result, a properly designed ribbon displays excellent frequency response characteristics, with a relatively high voltage output.

Maximum sensitivity is evidenced toward sound waves approaching the microphone at an angle of 90 degrees to the plane of the ribbon, with a corresponding loss of sensitivity to waves approaching at an angle of lesser degree. Since sound waves traveling in a plane identical to, or parallel to, the plane of the ribbon exert little or no pressure upon it, the resultant response pattern of the microphone becomes sharply bidirectional. Specific applications in which this characteristic may be used to best advantage will be discovered by experimenting with individual setups.

### The Unidirectional Velocity Microphone

In the RCA 77-A unidirectional microphone (Fig. 9) the principle of operation, by virtue of the unique manner in which the ribbon is constructed, is much the same as that of the cardioid microphone. The corrugated ribbon is suspended vertically between the two halves of a permanent magnet, the field of which is cut in the usual transverse manner. The ribbon, however, is divided into two equal sections which operate independently of each other, the upper half being responsive to the pressure of sound waves and the lower half actuated by air particle velocity and acting as a conventional ribbon unit.

The upper section is made to operate as a pressure unit by allowing the ribbon to vibrate freely as usual, but with the back section enclosed in a metal housing terminated in an infinite impedance in order to prevent a rising response characteristic at the higher frequencies. A practical means of attaining such an impedance is by the use of a number of metal plates approximately 3/4 inch thick and 4 inches in diameter, placed one upon the other to form a cylinder. The inside portion of each plate is spiral-shaped, with a small opening at the beginning and end of each spiral which corresponds with a like aperture in each succeeding layer of plates to form a continuous labyrinth, each layer being loosely packed with absorbent material to aid in reflection damping.

In the RCA 77-B, a long hollow tube, tightly packed with absorbent felt padding and coiled to facilitate overall compactness is used instead of the cylindrical labyrinth.

Since the output of the pressure unit may be expressed as unity, and since the bidirectional response is equal to the cosine of the angle of approaching sound, the combined output can be expressed as  $E = E_0 (1 + \cos \theta)$ , or

**RADIO NEWS**



OLSON RADIO WAREHOUSE, INC. AKRON 8, O.

**NEW! OLSON "AKRAD" CONDENSER**  
**FREE YOUR RADIO OF HUM!**

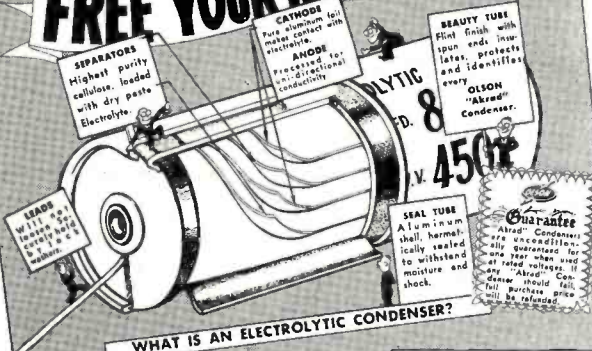

WHAT IS AN ELECTROLYTIC CONDENSER?

*New* **Comic Poster**  
**FREE!**

TO DISPLAY IN YOUR WINDOW:  
Another OLSON crowd-puller! Get this new giant-size Window Poster absolutely FREE, postpaid, just by sending the coupon below. Actual size of Poster, 17" x 22". It explains in pictures and easy-to-understand words how Electrolytic Condensers work. The upper half is a large diagram showing the parts of a Condenser, and the lower half has five big, amusing cartoons comparing the Condenser with a cheese sandwich and the corroding agent as a mouse. People will STOP and look at this swell Poster in your window or Service Dept. Along with the Poster you get a FREE CATALOG listing Olson's famous Radio Parts at prices that will save you plenty!



ACTUAL POSTER HAS 5 CARTOONS  
THESE TWO ARE ENLARGED TO SHOW DETAIL

PASTE THIS COUPON ON A POSTCARD AND MAIL TODAY

**OLSON RADIO WAREHOUSE**

73 E. MILL ST., DEPT. 93, AKRON, OHIO

Yes sir! Send me the New Comic Poster free.

NAME \_\_\_\_\_  
COMPANY \_\_\_\_\_  
ADDRESS \_\_\_\_\_  
CITY \_\_\_\_\_ STATE \_\_\_\_\_

**HAMS! EXPERIMENTERS! Look at these EXCLUSIVE "G&G" BUYS!**

**Sensational Value! 80-Meter RECEIVER**  
RCA Model AVR-20-A LIMITED QUANTITY! ALL BRAND NEW! Originally designed for Aircraft. Tunes 2300 to 6500 Kc. Perfect for 80 meter Ham work. Crystal controlled. Phone and CW. Provision for low and high impedance phones. Tubes used: 6B8, 6F7, 6S7, 6K8. 3-gang tuning cond. vernier tuning. Designed for 6 volt operation. Easily converted to 110 volts AC. Less power supply. SENSATIONAL GIVE-AWAY PRICE. **\$8.95**

**EXCEPTIONAL BUY For Industrial, Research Labs, Experimenters!**  
**"LAVOIE" MICRO-WAVE FREQUENCY METER 300 to 600 Mc.**

Truly a terrific buy—but hurry! We've got only a few of these! Complete laboratory-type frequency meter 300 to 600 Mc. Each unit has hand-calibrated chart in cover. Panel has high-precision vernier tuning control, 0-200 DC Weston microammeter, gain control, modulated and unmodulated control knob, phone jack, on-off switch. BRAND NEW, in polished wood carrying case, leather handle. Self-contained power supply and all tubes, included. It's all yours, for only **\$59.50**

**ARMY AIRCRAFT RECEIVER—BC-946-B**  
Covers 520 Kc to 1500 Kc Broadcast Band. Tubes: 3—12SK7, 1—12SR7, 1—12A6, 1—12K8. Designed for dynamotor operation; can be easily converted to 110 volt or 32 volt use. Two IF Stages. Three-gang tuning cond. BRAND NEW, in sealed carton, with tubes and instruction manual, less dynamotor **\$12.95**  
DYNAMOTOR DM-32A. **\$1.95**

**PE-104-A VIBRATOR POWER SUPPLY**  
Works on 6 volt or 12 volt Battery. Supplies 84 volts and 51 V DC, also 1.4 Volts "C" Bias. Size 7"x4"x3 1/4". Can be used to operate above receiver, as well as any other application requiring these voltages. ALL BRAND NEW. LIMITED QUANTITY—VERY LOW PRICE! While they last. **\$4.95**

**HERE ARE PM SPEAKER VALUES FOR YOU!**

All Less Transformer

4" PM	\$1.30
5" PM	1.45
6" PM	1.95
8" PM	3.25
10" PM	4.95
12" PM	5.95

Please include 25% deposit with orders—Balance C.O.O.

**SETCHELL CARLSON RADIO RECEIVER BC-1206-C**  
Designed to receive A-N Beam signals, operates on 24-28 V DC. Tubes: 3—14H7, 14R7, 28D7. Tunes 195 to 420 Kc. Size: 4"x4"x6 5/8" wide. 4 lbs. Complete with tubes. BRAND NEW in original carton. **\$7.95**  
Same as above, slightly used, IN PERFECT CONDITION. **\$4.95**

**WILLARD 2-VOLT STORAGE BATTERY**  
20 Ampere-Hours  
Exact replacement for GE portables—brand new. **\$2.75**  
Each.  
Willard 6 volt (3-cell) storage battery, brand new. **\$7.95**  
Willard 1-Quart Bottle Electrolyte. Enough for two 2-volt cells. Hermetically sealed. **95c** Per Bottle.

**FREQUENCY METERS**  
LM-10 and LM-11 Frequency meters, 12,500 to 20,000 kc. modulated complete with tubes and crystals, less power supply. Navy Type. In excellent condition. **\$39.50**

Astatic R-3 Crystal Handmike, with 6-ft. R.C. mike cable. **\$4.50**  
Shure T-17 Handmike. Single Button, with Push-to-talk switch. BRAND NEW. **88c**

**G & G RADIO PARTS SERVICE**  
53 VESEY STREET · NEW YORK 7, N.Y.

"More than 10,000 Satisfied Dealers and Servicemen since 1940!"

**5" SQUARE TRIPLETT**  
0-50 Microampere BASIC METER MOVEMENT 20,000 ohms per volt. Has 16 AC and DC scales including 0-1000 ohm scale. Very special value at **\$12.50**  
ASTATIC crystal pickups, with L-26 crystal cartridge. **\$1.79**  
3" ROUND DC MILLIAMMETER 0-1000 Milliamps. **\$1.95**

# HERSHEL BEATS BARGAINS WITH LOWEST PRICES ON QUALITY MERCHANDISE!

## Radio Tubes

813.....	\$ 5.45
RK60.....	1.25
VT127.....	2.95
VR150.....	.69
829.....	2.45
872.....	1.95
955.....	.65
9004.....	.65
6J4.....	1.50
6J6.....	.95
3APT.....	2.45
3BP1.....	2.45
5BP1.....	3.95
5CP1.....	3.45
5FP7.....	3.45
7BP7.....	4.45
9LP7.....	5.45
304TH.....	6.95
1T4-354-3Q4-6SN7-6SL7-6SA7-5U4G-5W4-35W4, ea.....	.59
5U5B.....	.79

## Condenser

Cat. No.	CAP. MFD.	Working Volts	Your Cost
C110.....1.....	5000 Oil.....		\$ 3.95
C112.....1.....	1000 Oil.....		.44
C114.....8.....	600 Oil.....		.95
C115.....2.....	600 Oil.....		.49
Westinghouse 1 MFD 6000 volts WVDC.....			7.95
Westinghouse 1 MFD 10,000 volts WVDC.....			12.95
General Electric 25 MFD photo flash pyranol-capacitor, 2000 VDC-INT.....			14.95
IRC type HE resistor 200 wt. tapped at 3000, 7500, 23,750 ohms, Brand new.....			.49
144 MC Radar Osc. uses 15E or with variable coupling. Complete less tube.....			3.95
Thordarson 300MA Power Transformer 100 or 220 V 60 cy. input. Secondary: 500/ct/500 tapped at 450/450. Extra bias winding 200/ct/100 at 50ma. 18 lbs.....			4.95
BC 191E less tubes and tuning units.....			14.95
5V Filament Transformer 60 amps. 22 lbs.....			5.95
Ear Phones. 2000 ohms, used—in good condn. Ass't resistors 1/2 watt fully insulated in popular ohmage. Cat. No. R-5 per 100.....			1.49
.1 MFD 7000 WVDC Sprague.....			1.95
Plate transformer. Shelled Case. 110-V 60 cy. Pri. 800 VAC-200 MA. Sec. not tapped.....			3.95
Wafer Sockets, 4-5-6-7 and 8 prong. Cat. No. WF-4 Per 100.....			2.95
12" Utah P.M. Speaker Alnico No. 5 with 6F6 output transformer. Cat. No. ST-100.....			6.95
Ass't knobs push on wood and plastic. Cat. No. KP-100—per 100.....			1.95
Johnson sockets No. 217-25W. Cat. No. JS-210			.49
Sockets for acorn tubes. Cat. No. AT-10.....			.19
Jacks PL 55, PL 68.....			.15
1 Meg. Shalicross Acra-Ohm wire wound resistors ± 1W.....			.89
5 gang app. 50 MMFD per sec.....			1.95

BC-654, Transmitter and receiver, used.....	\$14.95
SCR522 Trans. and Rec. with tubes and Xtal 200KC with tube and Xtals like new.....	29.95
Modulation Transformer 1KW.....	14.95
Famous Boat Anchor Transmitter and Receiver. Scope Supply Transformer 4000V.....	3.95
30MC IF Transformer.....	.29
Corona Balls, dozen.....	1.00
Filament Transformer 110V, 60 cy. pri. Sec. 5V-3A shelled case.....	1.49
Filament Transformer 110V, 60 cy. sec. 2.5V at 5.25 amps. shelled case.....	2.45
Filament Transformer 110V, 60 cy. sec. 1.5V at 10 amps. sec. 2.5V at 10 amps. connected in series will give 10V at 10 amps. shelled case.....	3.95
General Electric meter, type DO41, 0-10-MA, or 0-500MA 3 1/2" round case, ea.....	3.95
BC223 AX Transmitter, Brand new.....	29.95
Variac 1 amp.....	3.95
Variac 5 amp.....	7.95
Assorted HF. chokes, dozen.....	.50.

**BRAND NEW SCR269F Automatic Direction Finder Radio Compass complete with component parts 7500**

Minimum order \$2.00 f.o.b., Detroit. Michigan sales, add 3% sales tax. 20% Required on all c.o.d. orders.

**HERSHEL RADIO CO.**  
5249 Grand River  
DETROIT 8, MICHIGAN

WATCH OCT. ISSUE for Announcement of Hershel's GIGANTIC SALE

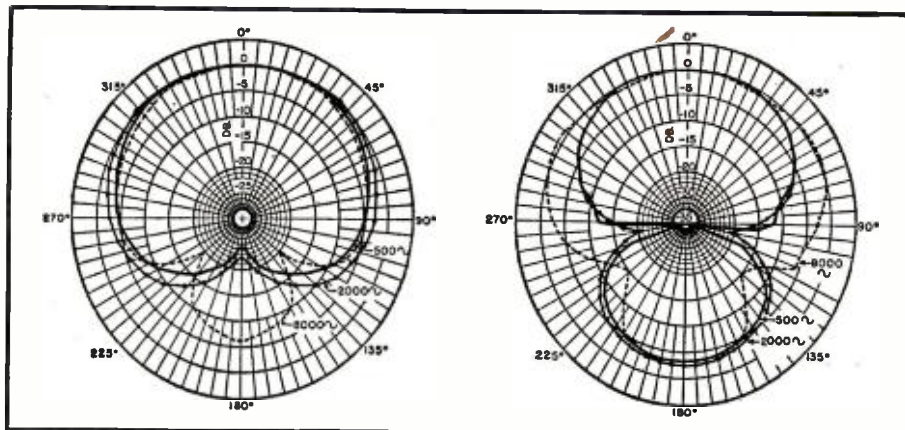

Fig. 10. Frequency response characteristics of the WE 618-A.

the familiar cardioid directive pattern.

This type of microphone has an output level of approximately -81 db., where 0 db. = 1 volt per bar (open circuit voltage) across a 250 ohm output impedance.

Referring to the characteristic pattern shown in Fig. 10, it is seen that maximum response is afforded to sound waves approaching at right angles to the lateral plane of the ribbon from the front side, while the small lobe as evidenced at the rear in the response pattern indicates practical elimination of sound waves from this direction. The advantages of such a pickup pattern lend the microphone to a variety of applications.

### The Cardioid Microphone

An explanation of cardioid directivity is best given through a detailed examination of the characteristics of a typical cardioid microphone. Such a microphone is the *Western Electric 639-A* (Fig. 11), whose directive pattern resembles the heart-shaped or "cardioid" plot of the mathematical

term  $(1 + \cos \theta)$ , hence its name. This pattern, which makes possible a wide-angle pickup of 120 degrees, is the result of the utilization of the combined outputs of a nondirectional dynamic unit similar to that of the 630-A and mounted vertically as a semidirectional unit, and a specially constructed bidirectional ribbon unit, both being housed in the same case.

It is well known that sound will flow around corners or curved surfaces and since the case holding the dynamic unit is so designed, sound waves approaching from the back of the microphone follow the rounded contour of the case to the front of the diaphragm, thereby causing it to move in the same direction in response to sound waves arriving from the back and sides as to those arriving from the front. Thus the diaphragm always moves in one direction only, and the output of the microphone maintains a constant phase relation. For this reason its output may be represented mathematically by a whole number, such as 1, or unity. The bidirectional velocity

Fig. 11. The Western Electric 639-A cardioid directional microphone.

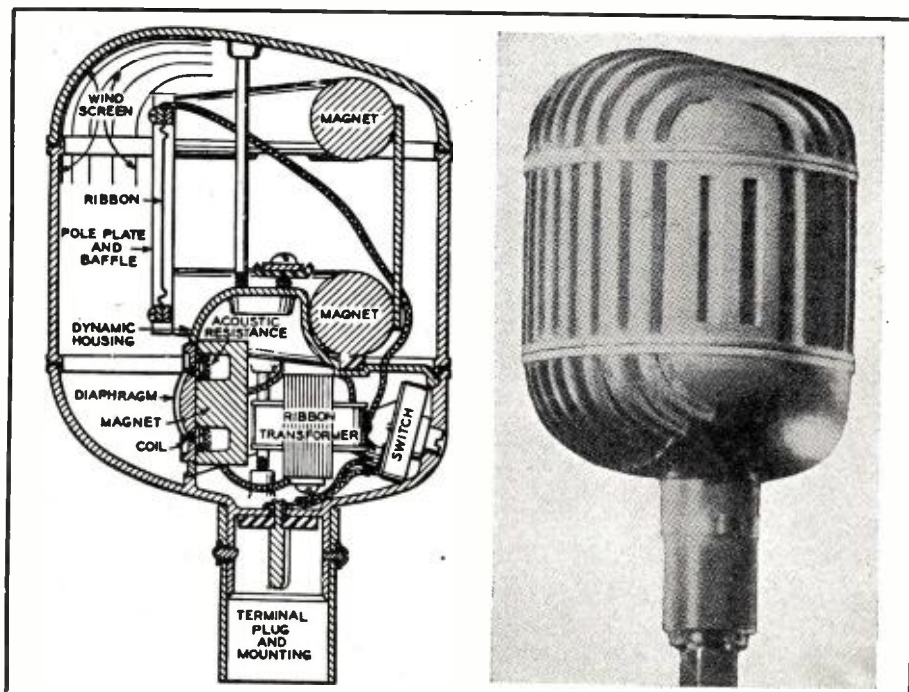

unit, however, responds to sound waves approaching from two opposite directions, and as a result the ribbon reverses in phase each time the direction of sound is reversed. This phase reversal is proportional to the cosine of the angle of the approaching sound, and a combination of the two outputs ( $1 + \cos \theta$ ) approximates the true cardioid.

The unique structure of the ribbon allows a practically uniform response over the low and high frequencies as well as the middle frequency range. Normally, a conventional ribbon unit, when used in conjunction with a dynamic unit, tends to discriminate to some degree all frequencies above and below a certain medium range, resulting in an unbalanced condition of pick-up with accompanying frequency distortion.

Physically, the ribbon designed for the 639-A is less than half the length of an average ribbon, is decidedly narrower, and is corrugated at either end, with its center section straight in relation to the front of the microphone. Since this portion is concave to the back of the microphone, it presents slightly more acoustical resistance to sound waves traveling in this direction than to those arriving from the front, thus aiding in equalizing the pickup from both directions, and presenting a closer approach to a true bi-directional pattern. This form of ribbon construction also affords less resistance to wind, prevents possible twisting of the ribbon, and contributes to its over-all ruggedness.

General construction of the 639-A is shown in the cross-sectional diagram of Fig. 11. The three-position switch in back of the housing is slotted for screw-driver operation, and allows selection of three directional patterns—*C* for cardioid, in which both units are combined; *D* for dynamic, in which the pressure unit alone is connected; and *R* for ribbon. In the 639-B six positions are available, the extra three being used to give varying degrees of directivity to the cardioid pattern.

Output impedance of the 639-A is 30 ohms, and its output level is -85 db. with reference to 1 volt/bar or .006 watt.<sup>3</sup>

<sup>3</sup> Ledbetter, John B., "Broadcast Microphones" Radio-Electronic Engineering Edition of Radio News, June, 1946.

(To be continued)



September, 1947

# Only YOU hear it!

Hushatone special design gives it excellent tone quality when used under pillow or similar covering.



Small extension unit has excellent fidelity.

Compact — Hushatone is only  $4\frac{3}{16}$ " in diameter and  $1\frac{1}{16}$ " thick. Slips easily under pillows wherever needed.

## New miniature under-pillow unit means end to "radio irritation"...

The Hushatone\* is a small, streamlined under-pillow unit which assures private radio enjoyment without disturbing others. It's compact—only  $4\frac{3}{16}$  inches in diameter,  $1\frac{1}{16}$  inches thick. Cannot be felt under bed or sofa pillow. Special design assures tone quality comparable to full-size radio. Easily connected to radios. Can be dipped into disinfecting solution—washable (hermetically sealed). Complete with convenient, durable cord. At radio dealers everywhere:

# Hushatone\*

a product of The Brush Development Co.

3405 Perkins Avenue  Cleveland 14, Ohio

\*Trade Mark Reg. U. S. Pat. Office



# RADIOLAB

## Electronic Equipment for Schools

### DEMONSTRATIONS WITH

- Multi meters
- Signal Generators
- Oscillographs
- Radio Kits

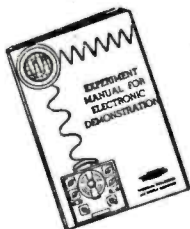

By S. D. PRENSKY  
60 Page Demonstration Experiment Manual

Supplied to purchasers of test equipment at no extra cost. To obtain separately, send \$2.00 which is refunded when test equipment is purchased.

Check for our regular catalog of

## TEST INSTRUMENTS

listing selected items, suitable for instruction purposes

### ADDITIONAL SPECIAL ITEMS

Check individual squares for special circular on these items.

**REGULATED POWER SUPPLY:** Input 117 v. 60 cycle,  $\pm 15$  v., output regulated to within 1%, from 130 to 230 v. D.C., at 50 ma.; 6.3 v. A.C. output (unregulated), at 3 amps.; highly compact and reliable (not surplus); Model 2000-LM ..... **\$37.60**

The items listed below, but no other instruments we supply, are Signal Corps items, and are subject to prior sale:

**HAND GENERATOR, D.C.:** 8 v. at 2.5 amps, and 345 v. at 100 ma., filtered, with automatic voltage regulator, suitable for many experiments ..... **\$7.50**

**BASIC-MICRO-AMMETER AND GALVANOMETER, 4 1/2"** Westinghouse aircraft type, two independent sensitive movements, may be used separately with two printed scales furnished, either for 100-0-100 ua. or for 0-200 ua.; making a fine foundation meter or galvanometer, Model WN ..... **\$5.75**

**LABORATORY POTENTIOMETER** (General Radio type), 25 watts, 100,000 ohms, suitable for bridge or accurate voltage divider use, Model LR ..... **\$3.95**

**V.H.F. TRANSMISSION AND RECEPTION UNIT,** conveniently adaptable, with fully illustrated instructions, to demonstrate VHF transmission in citizen's band (or from 420 to 490 mc.), with ample power output for Lecher wire tuning, and sensitive linear lines receiver, Model 6L5, complete with 15 tubes ..... **\$36.95**

**HIGH-FREQUENCY SIGNAL GENERATOR AND HETERODYNE WAVEMETER,** precision type, with crystal checked calibration, covering from 8 mc. to 230 mc., and usable up to 460 mc. and beyond, 115 v. 60 cycle operated; remarkably accurate and well built by Belmont—an ideal lab. unit, complete with tubes, co-ax cable and self-contained antenna, Model LI-222A ..... **\$72.50**

20% deposit required on C.O.D. orders.

**RADIOLAB PUBLISHING & SUPPLY CO., Inc.**

652 Montgomery St., Brooklyn 25, N. Y.



## What's New in Radio

(Continued from page 80)

with facilities for the use of up to 24 master stations, permitting as many as 12 conversations to be carried on simultaneously.

Rauland Corporation, 4269 N. Knox Avenue, Chicago 41, Illinois, will supply complete information on this unit to those requesting it.

### POCKET TEST INSTRUMENT

Feiler Engineering Co. of Chicago has recently developed a pocket test instrument, the "Stethoscope" Model TS-5.

Utilizing miniature type tubes, this instrument measures only 4 1/8" x 1 1/8" x 7 1/2", and weighs 3 1/2 pounds.

The probe is of the high-sensitivity

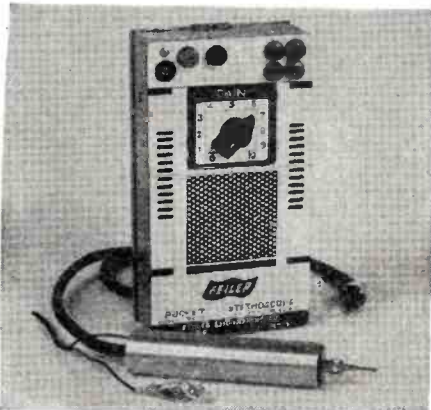

type and has a built-in high gain miniature tube. Actual amplification is provided at the signal point and a 3" PM dynamic speaker gives positive response for the tracing operation.

The gain control is continuously variable. Provision has been made for connecting this instrument to any standard type voltohmmeter or r.f. vacuum tube voltmeter. Any impedance headphones, either crystal or magnetic, or an output meter can be connected by means of a jack. Operation is on 105-125 volts, either 50 or 60 cycles.

Additional information will be supplied by Feiler Engineering Co., 422 South Dearborn, Chicago 5, Illinois.

### PLUG-IN ELECTROLYTICS

A new line of plug-in electrolytic condensers, especially designed for experimental, test, and other applications where quick condenser changes are required, is being announced by Cornell-Dubilier Electric Corporation of South Plainfield, New Jersey.

Designated the Type QC, the new units are hermetically sealed in round aluminum containers which are equipped with a four-pin octal base mounting which permits their ready removal or replacement in standard tube sockets.

The line is available in a popular range of capacity and voltage combinations, including multiple sections. Units for special requirements may be secured by special order.

## SIGNAL GENERATOR

Wide Range FM-AM Television

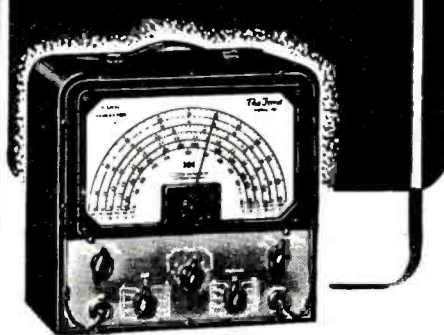

### Model 701

Range: 170 K.C. to 115 M.C.—all fundamentals.

Crystal calibrated, low loss permeability tuned coils. Internal 400 cycle sine wave modulation —to 100%. Follow-up shorting Turret coils with no dead spots. Tubes: 6C4, 6AU6, 6X4. Vernier drive — 9" easy-to-read scale.

Ladder attenuator **\$74.95**  
—triple shielded. Net



Write for catalog sheet  
Dept. 9-A

## Coastwise Electronics Co., Inc.

130 North Beaudry Ave., Los Angeles 12, Calif.  
New York Office & Warehouse  
258 Broadway, New York 7, N. Y.

# "TIK" for KITS

## Servicemen Amateurs Jobbers

Look at these values

Mica Condensers Assorted, 100 for .....	<b>\$3.49</b>
Allen Bradley, etc., Volume Controls, 50 ohm to 1 meg, 12 for .....	<b>\$2.59</b>
Carbon Resistors, Color Coded, 1/2, 1 & 2 watt, 100 for .....	<b>\$2.50</b>
Wire Wound Resistors, Ward Leonard, etc., 5 to 75 Watt, 20 for .....	<b>\$2.98</b>
Fuses, Buss & Littlefuse, 100 for .....	<b>\$1.89</b>
Assorted oil filled condensers, tubular and bathtub type, 400 V, 600 V, 1000 Volts, 12 for .....	<b>\$2.49</b>
Octal and 4 prong Ceramic Sockets (without rings), 100 for .....	<b>\$3.98</b>
Condensers, .05 mfd, 2000 volt to .25 mfd 3,000 WVDC, 6 for .....	<b>\$3.59</b>
Precision Wire Wound Resistors, Shallcross, Mepec, etc., 1/4, 1/2 and 1 Watt, 15 for .....	<b>\$2.98</b>

### SPECIAL COMBO KIT

#### OUR INTRODUCTORY OFFER

Excellent Assortment—Big Value—Tremendous Savings

This kit includes a quantity of items listed in the above kits, PLUS many others. It's our New Customer Special. **\$10.98**

Minimum Order \$2.00  
25% deposit required on all C.O.D. orders  
Add postage Write Dept. RNS.

**"TIK"** 55 WALKER ST.,  
NEW YORK 13, N. Y.  
phone CAnal 6-7485



Bulletin No. 100-425 which contains complete information on the line will be supplied by *Cornell-Dubilier Electric Corporation*, South Plainfield, New Jersey, to those requesting a copy.

**PORTABLE VOLT-OHMMETER**

The *Hickok Electrical Instrument Company* of Cleveland, Ohio has just introduced their new Model 214 port-

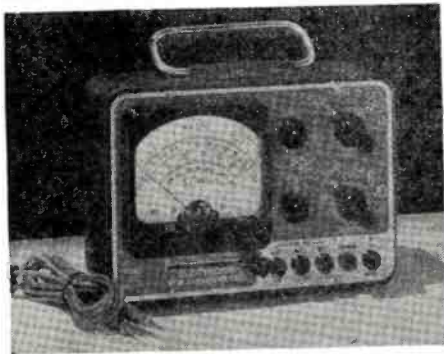

able electronic volt-ohmmeter, a completely self-contained, battery-operated unit for servicemen.

This unit may be used in rural areas or for checking radio receivers in the field. For resistance or voltage tests, sets need not be removed from autos, ships, or aircraft. The unit is built for self-checking of battery condition at any time and is usable for 1350 complete cycles of 4 minute operations.

The Model 214 has six a.c. voltage ranges, 0-3, 12, 30, 120, 300, 1200 and six d.c. ranges, 0-3, 12, 30, 120, 300, 1200 and covers from 1 ohm to 1000 megohms in six ranges.

The unit weighs 5½ pounds and measures 8¼" x 6" x 4¼". Complete details will be supplied by *The Hickok Electrical Instrument Company*, 10524 Dupont Avenue, Cleveland 8, Ohio, upon request.

**CUSTOM INSTALLATION FM-AM**

Of interest to radio servicemen is the new line of radio chassis designed for custom installation which is now being manufactured by *Espey-Philharmonic Radio Co.* of New York.

One of these units, the Model 7-B,

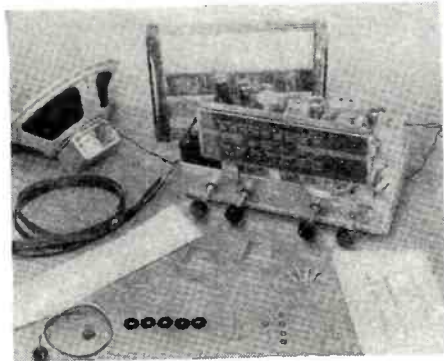

is an 11 tube superheterodyne AM-FM receiver designed to operate on 105-125 volts a.c., 50-60 cycles. This receiver features a.v.c., full-range volume control, full-range combination bass-treble tone control, 13 watt push-pull audio output, loop antenna for AM and folded dipole for FM recep-

# SAVE AT JOSEPH'S

## POPULAR TUBES!!!

AT POPULAR PRICES

1G5	2C26	6AB7	6F6	6SG7	<b>YOUR CHOICE</b>	7N7	12SF7	31	VR105
1R5	3B7	6AC7	6H6	6V6	50c	12AT6	12SG7	35L6	954
1S5	3S4	6AG5	6J5	6X5		12BA6	12SK7	35W4	955
1T4	5R4	6AG7	6J6	6Y6		12BE6	12SN7	35Z4	956
6SJ7	5U4	6C4	6SA7	6F8		12SA7	12SQ7	50B5	9006

2C40—\$2.50    3B24—\$3.00    5CP1—\$3.95 w-socket    715B—\$3.00    724B—\$1.00  
**SPECIAL BONUS: Deduct 10% for orders of \$20.00 and over on all tubes.**

## HOT DEALS!!!



**PAPER CONDENSER ASSORTMENT**

100 Brand New Paper Condensers. No Odd values. All 200-600 WV from .001 to .25 MFD.

You Can't Miss At **\$3.85** per kit



**RESISTOR ASSORTMENT**

100 Carbon and Wire Wound Resistors. ½ 1-2-5-10 W. No Odd values. All Brand New Stock.

A Real Buy At **\$1.95** per kit



**MICA CONDENSERS**

50 Mica Condensers for the price of 10! .00001 to .05 MFD. 300 to 600 V.

Unbeatable Value at **\$1.95** per kit

**35 W 110 VAC AMPLIFIER KIT 7 Tube**



COMPLETE with tubes, etc.

**\$19.95** per kit

Two 6L6 push-pull. 4 Controls. 3 inputs. Everything mounted on beautiful gray enamel chassis.

**ELECTROLYTIC CONDENSERS**

30x30—150 V; 20-25 V Paper Electric Condensers.	50c	10 For	\$3.90
Each			
8x8—475 V Metal Can Condensers		Ea.	75c
10 For			\$6.00
2x50—50 V; 2x30—350 V; 2x30—Neg.; One Can.	\$1.00	10 For	8.00
Ea.			

**Radio-F.M.-Television-Electrical Parts**

**25 Lbs. of USABLE PARTS**

WE ARE SWAMPED with tremendous quantities of parts that cannot be placed in our regular stock. We MUST SELL at the Ridiculously Low Price of—25 Lbs. For **\$3.00**

## WHILE THEY LAST! SCR-694 BC-1306 U. S. ARMY LATEST

### MOBILE TRANSCEIVER

- Contains Ten Tubes, plus Fifteen Spares.
- Freq. Range: 3800-6800 KC.
- Compact Unit: 6'x9"x14".
- Superhet Receiver.
- Transmitter with Modulator and B.F.O.
- Operates from 6, 12, 24 V Vibrator Supply.
- Can Be Operated Easily by One Person.

GUARANTEED TO CONTAIN EVERYTHING TO OPERATE, INCLUDING GN-58, HAND GENERATOR, ANTENNA, MIKE, PHONES, etc., etc., etc!

Gross Shipping Weight —205 Lbs.

BRAND NEW! ORIGINAL CRATE! ONLY

**\$49.50** F. O. B. Chicago

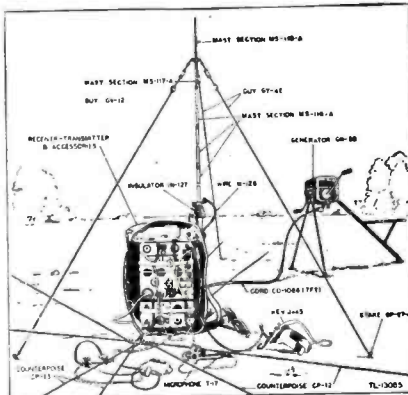

All items listed above are subject to prior sale. Terms, cash with order F.O.B. Chicago. Ill. Please remit postage charges. Attention Manufacturers: Write us your requirements.

**IRVING JOSEPH ★ Radio Parts**  
 220 S. Halsted St. Chicago 6, Ill.

10 inch  
TELEVISION  
NOW **124.50**  
LESS  
TUBES

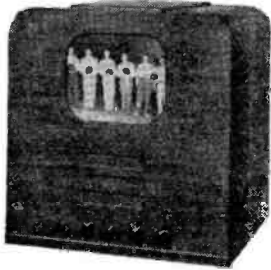

## AMAZING LOW COST

Designed by Television Training Institute of Philadelphia—where thousands of students in this and other leading television schools assemble Telekits as part of their training.

Thorough, easy-to-follow, step-by-step instruction books included with each Telekit. Pictures, schematics, diagrams and service notes.

New TTI interlock circuit for horizontal and vertical sync control—holds the picture steady even at low signal strength and at noisy locations.

High quality FM sound reception—without distortion to give you true listening pleasure.

Pre-tuned I.F. coils making alignment simple.

Switching arrangements for five bands.

**GUARANTEED TO WORK**—Ask your jobber about the authorized service station plan. There is one in each Television city.

Remember, No. 10 Telekit is a full ten inch television receiver kit that is comparable to commercial receivers. No. 10 cabinet \$29.50. No. 10 Tube Kit with all tubes (including 10BP4) \$64.50.

## SEVEN INCH TELEKIT \$77.50 (LESS TUBES)

Number Seven Telekit is easy to assemble. Perfect set for the television beginner that is Guaranteed to receive sound and video of an excellent quality. Complete instruction books with each kit.

See the Telekits at your jobber or write for FREE BOOKLET.

# TELEKIT

ELECTRO-TECHNICAL INDUSTRIES  
121 NORTH BROAD STREET PHILADELPHIA 7, PA.

tion, and provision for phonograph operation.

The chassis is 13½" x 9" x 9" and is ready to be installed in either a table cabinet or console, or any other piece of furniture adapted as a cabinet.

Details on the entire custom installation line of radio chassis will be furnished by *Espey-Philharmonic Radio Co.*, 528 East 72nd Street, New York, New York.

### HAND TRUCK

*The Handees Company* of Bloomington, Illinois are featuring a new appliance and industrial hand truck, their Model 88R.

Designed particularly for the handling of large items, refrigerators, console receivers, and crated merchandise, this truck has a load capacity of 1000 pounds and is constructed of tubular steel. Standard equipment includes a heavy web strap 12 feet long complete with non-slip buckle and protective tip. A removable nose-piece of ¼" steel plate 24" wide provides for easy handling of larger items. The truck is 54" high. The dual-mounted solid rubber wheels are equipped with Chrysler Oilite bearings which are prelubricated.

Full details on the Model 88R, including price, will be furnished upon application to *The Handees Company*, Dept. 777, Bloomington, Illinois.

### NEW SWITCHES

Production on two new single and double section switches has been announced by *P. R. Mallory & Co., Inc.* of Indianapolis.

Designed to be used where space and low cost are governing factors, these new circuit selector switches have identical section and terminal design as those of the Model RS-50

and RS-60 switches. These units, which may be used for band and tone control switching in radio receivers and other electronic applications

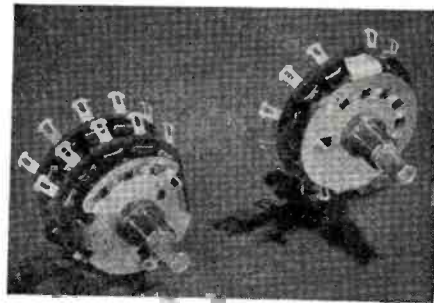

where medium and low torque indexing action is desired, are known as the RSA-50 and RSA-60.

Either of the models is available in one or two section construction. The RSA-50 accommodates up to twelve terminals on either side of the section and provides from 2 to 6 positions. The RSA-60 accommodates up to ten terminals on either side of the section and provides from 2 to 5 positions. This latter model has a narrow section design which is suitable for under-chassis mounting where space is at a premium.

Data sheets and complete specifications on these new switches will be furnished upon request. Address inquiries to *P. R. Mallory & Co., Inc.*, Indianapolis, Indiana.

### BUTTON-CONTROL FLOOR STAND

*Electro-Voice, Inc.* of Buchanan, Michigan has announced the availability of a new Utility Model 430 button-control floor stand for studio, p.a., and recording work.

A single red button provides instant fingertip control of shaft height. The

When Radio Products Sales, Inc. of Los Angeles opened their new building approximately 5000 persons turned out to look over the company's complete line of radios, appliances, ham gear, and electronic equipment. This well-planned sales floor has been designed to provide customers with the most modern shopping facilities. A 50-car parking lot adjoining the building is provided for the convenience of the customers.



# TERRIFIC... say users of "Premier" B·A·N·D·S·P·R·E·A·D DIAL SIGNAL GENERATOR

## EXCLUSIVE FEATURE!

The "PREMIER" Model 570 is the ONLY low-priced Signal Generator with a MICRO-MASTER BAND-SPREAD DIAL, equivalent to a scale length of approximately 60"—a major feature for logging, sharp and critical tuning.



- AIR TRIMMERS ON ALL BANDS.
  - TRIPLE COPPER PLATED SHIELDING.
  - EFFECTIVE LINE FILTER—pure 400 cycle modulation (less than 5% distortion).
  - Range 75KC-50MC on fundamental, and 50-150MC on 3rd harmonic, useful for aligning FM and Television Receivers.
  - Accuracy better than 1%.
  - A.C.—115 volts, 50-60 cycles.
  - Overall size—12"x12½"x5½". Shpg. wt. 21 lbs.
- Manufactured by Premier Electronic Labs., N.Y.C. Immediate Delivery!  
Complete with co-axial cable and operating instructions. 25% deposit, balance C.O.D.

**\$54<sup>75</sup>**  
NET

**METROPOLITAN ELECTRONIC & INSTRUMENT CO.**  
Dept. RN-9 42 Warren Street New York 7, N. Y.

## Fixing Radios the Old Hard Way?



The Feiler Stethoscope does everything but make the actual repair. And the Stethoscope does it faster, better and much easier. Thousands of radio men, many with little experience, are already fixing radios and other electronic equipment this new way.

You will find that just this one low priced unit and a few basic hand tools are all you need to fix practically any radio.

Here is the new Model TS-5 "Pocket Stethoscope" built to take out on the job. It's light, compact and rugged yet performs like the bench models. Stethoscopes are available in 4 types ranging from \$9.85 to \$34.95.

The "Inside Story" of the STETHOSCOPE—how it works—how it instantly locates trouble in any circuit—is yours for the asking. Just send us your name and address on a penny post card or see your Jobber.

Available for Export—Choice  
Territories Still Open

"MAKES RADIO REPAIRS  
AUTOMATIC"



**FEILER ENGINEERING COMPANY**

422 South Dearborn St., Dept. 1G7, Chicago 5, Illinois  
September, 1947

# Tops for FM

STANDARD BROADCAST  
AND SHORT WAVE

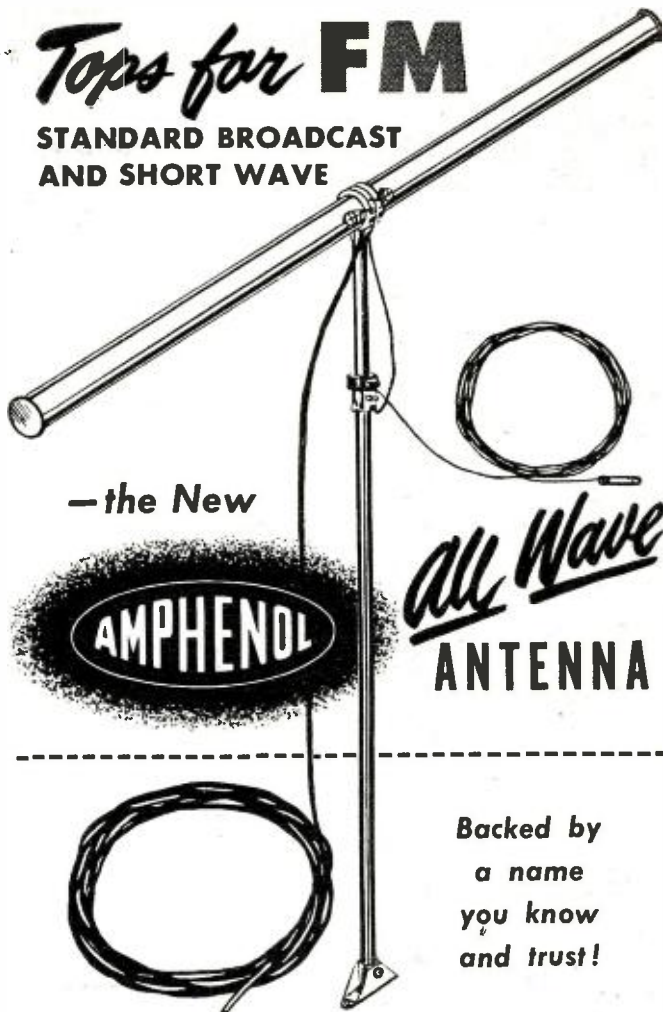

—the New

**AMPHENOL**

*all Wave*  
**ANTENNA**

Backed by  
a name  
you know  
and trust!

- In actual tests, over the 500 kc-108 mc frequency range, the new Amphenol All-Wave Antenna out-gains the best double doublet. It assures interference-free reception, even in areas of low signal strength.
- The All-Wave Antenna combines a horizontally polarized FM dipole with a 65-foot copper wire antenna for standard broadcast and short wave. A special wave filter channels energy to receiver input. A leadin of 52 ohm coaxial transmission line reduces interference to the minimum.
- The All-Wave Antenna is individually packaged for unit sale with installation instructions, all hardware (except guy wires), and a guy wire clamp.

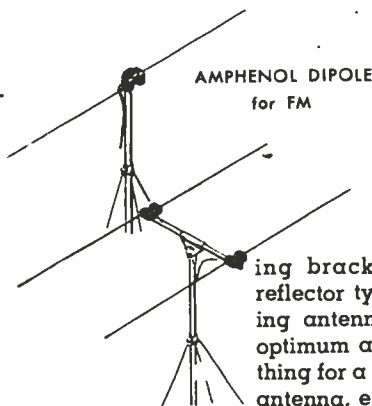

AMPHENOL DIPOLE  
for FM

- Amphenol dipoles, and reflector arrays, build up ample gain for finest reception of FM. Efficient, even in areas of low signal strength, they virtually eliminate multipath reception. Mounting bracket and masthead (of reflector types) swivel, thus allowing antenna plane to be tilted to optimum angle. Kit contains everything for a complete 88-106 mc band antenna, except guy wires.

Amphenol Dipole Antennas are available now thru your jobber, or get prices and technical data by writing direct.

**AMERICAN PHENOLIC CORPORATION**

1830 SOUTH 54TH AVENUE • CHICAGO 50, ILLINOIS  
COAXIAL CABLES AND CONNECTORS • INDUSTRIAL CONNECTORS, FITTINGS AND CONDUIT • ANTENNAS • RADIO COMPONENTS • PLASTICS FOR ELECTRONICS

**NOW YOU TOO CAN BUILD  
15 RADIOS**

**COMPLETE  
KIT  
\$14.75**



**ABSOLUTELY NO KNOWLEDGE  
OF RADIO NECESSARY**

**You Need No Additional Parts**

The **PROGRESSIVE RADIO KIT** is THE ONLY COMPLETE KIT. Contains Everything You Need: Instruction Book, Metal Chassis, Tubes, Condensers, Resistors and All Radio Parts.

The 36-Page Book written by Expert Radio Instructors teaches you to build radios in a professional manner. You will learn to wire and solder like an expert. You start with a 1-tube receiver. Before you are done with this kit, you will have built 11 Receivers, 1 Public Address System and 3 Transmitters.

**SPECIAL FREE OFFER!**

Electrical and Radio Tester with each **PROGRESSIVE RADIO KIT**

PLUS membership in Progressive Radio Club. Entitles you to free expert advice and consultation service with licensed radio technicians. Complete Kit shipped C.O.D. plus postage, or send check or money order for \$14.75 and we will pay postage. Or write for further information.

**PROGRESSIVE ELECTRONICS CO., Dept. RN-1**  
22 Havemeyer St., Brooklyn 11, N. Y.

- Check or money order enclosed. Postage Prepaid.
- C.O.D. I will pay postage.  Please send me further information.

NAME .....

ADDRESS .....

CITY..... ZONE..... STATE.....



**Inspection Lite  
Wire Stripper Kit  
Hell Box - Electronic Chemical Lab.**

**G-C INSPECTION LITE**

Just the light for service work, lights up hard-to-see corners. Handy many ways.  
No. 705.....List \$1.50



**G-C WIRE STRIPPER KIT**

Handy, complete with stripper and 7 different size blades in steel box. Strips wire No. 8 to No. 30.  
No. 744-K - Deluxe kit.....List \$17.00

**G-C HELL BOX**

Assortment of thousands of radio parts you use every day, in steel box (screws, washers, nuts, etc.).  
No. 6500.....List \$4.50



**G-C ELECTRONIC CHEMICAL LABORATORY**

Ideal for servicemen; 19 bottles & chemicals in heavy (free) steel rack.  
No. 998.....List \$11.12

Write for the new G-C 147 and Hardware Catalog of over 4000 items  
RADIO DIVISION DEPT. H

**GENERALCEMENT Mfg. Co., Rockford, Ill., U. S. A.**  
Manufacturers of over 3,000 products  
Sales offices in principal cities

- **RUGGED**
- **DEPENDABLE**
- **ACCURATE**

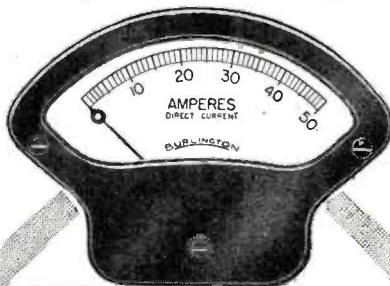

**Burlington**

PANEL

**INSTRUMENTS**

For utmost reliability—specify and depend upon Burlington Panel Instruments. They are designed, engineered and built to give satisfactory service even under most severe applications—and are fully guaranteed for one year against defects in material or workmanship.

Write today for full details

**BURLINGTON INSTRUMENT COMPANY**  
916 Fourth Street  
BURLINGTON IOWA

extension shaft may be raised or lowered when the button is pressed. The extension shaft locks in any position upon release of the red button. The weight of the microphone will not cause the stand to be lowered past the predetermined point. The shaft may be easily rotated without any adjustment.

This floor stand has height adjustment from 36" to 65". The leg spread is 17" and the net weight of the unit is 7½ pounds.

For further information write to *Electro-Voice, Inc.*, Buchanan, Michigan. Bulletin No. 134 contains the description of this unit.

**NEW MULTI-MASTER**

The new Series 858 Multi-Master, manufactured by *Precision Apparatus Co., Inc.* of Elmhurst, Long Island, features push-button operation and provides coverage of 54 a.c. and d.c. ranges.

This unit has a sensitivity of 20,000 ohms-per-volt and has been especially

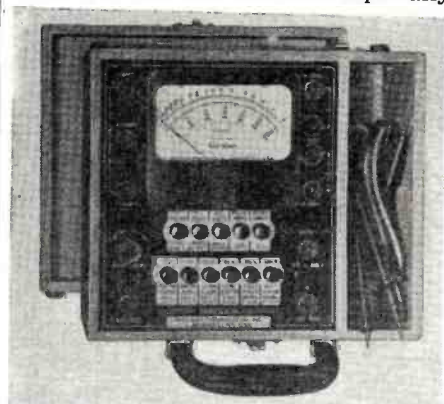

designed for electronic circuit measurements. One row of five buttons selects all functions such as volts, ohms, mils, decibels, amperes, and microamperes. The other row of six buttons selects all ranges.

The Series 858 is available in two models, the 858-P for portable operation while the 858-L is designed for laboratory use.

For additional information on this new Series 858 test unit write direct to *Precision Apparatus Co., Inc.*, 92-27 Horace Harding Blvd., Elmhurst, L. I., New York.

**TELEVISION RECEIVER**

*Dynamic Television Associates, Inc.* is offering a complete television kit which has been designed for construction by amateurs, experimenters, students, and servicemen.

Available in either the Model TU7A standard unit or the deluxe Model TU7DL the kit is furnished complete with all tubes including a *DuMont 7"* cathode-ray tube. The chassis is completely drilled and punched and no machine work is required. Construction diagrams are furnished.

Features of the unit include a 3.5 mc. bandwidth, 25.75 mc. trap-tuned, high gain video i.f. transformers, FM sound circuit, three stages of video i.f. amplification, and two stages of video amplification.

**RADIO NEWS**

Additional details and prices on these kits may be secured by writing

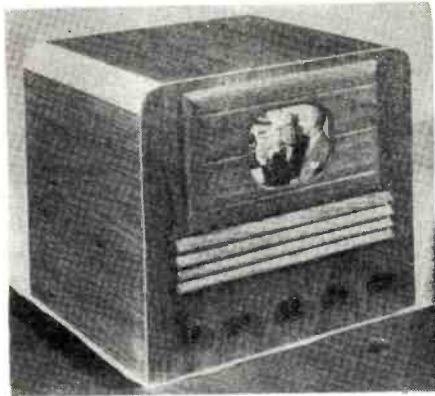

Dynamic Television Associates Inc.,  
155 Prince St., Brooklyn, N. Y.

### IRC CONTROL CABINET

A new popularly-priced kit of controls, the Junior Control Cabinet, has been introduced by *International Resistance Co.*, of Philadelphia.

The kit contains an active assortment of nine 1/2, 1, and 2 megohm controls, plus four switches and four special shafts.

Distribution is currently being made through IRC distributors, or *International Resistance Co.*, 401 N. Broad Street, Philadelphia, Pa., will supply additional details on request. -30-

### Learn as You Build

(Continued from page 42)

the paper condensers sorted from the ceramics, the micas, and electrolytics, and the several sizes of resistors sorted according to their wattage values.

If available, adhesive tape identification symbols can be affixed to the various parts as indicated in the parts list. When adhesive symbols are not available, hand lettering will, of course, suffice.

The markings used for identification, it will be noted, are the same as those used in the schematic diagram. This makes possible either construction from the diagram or an assembly based on production line procedure in which each operation is processed through the use of previously identified parts.

The resistors, after being separated according to wattage rating, should then be subdivided according to the first significant color band, which is the one farthest away from the silver or gold tolerance band. When all are accounted for, the "R" numbers can be affixed and the resistors arranged numerically by racking them in a strip of corrugated board. This will facilitate locating any resistor quickly during construction and it will be found to be most convenient, even to experienced constructors.

Starting with the bare chassis, the sockets are the first units to be assembled on it and right at the start

## SELECTED SURPLUS—"THE CREAM OF THE CROP" NEW CONDITION . . . NONE FINER AVAILABLE ANYWHERE

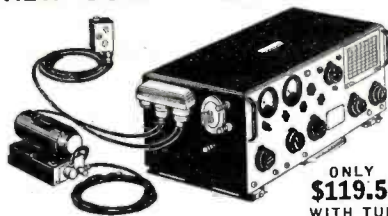

ONLY  
**\$119.50**  
WITH TUBES

### COLLINS ART-13 TRANSMITTER

We offer a small lot of Collins ART-13 Transmitters at the lowest price at which this excellent equipment has ever been sold. The frequency range is 2,000-18,100 KC. in ten channels, voice, CW or MCW. Included with each set are the following: 1 28-volt dynamotor, 1 Pilot's Control Unit and the necessary connectors, as illustrated. Output power is 100 watts normal at 90% modulation. This equipment is in PERFECT condition, having been removed from naval aircraft, and much of it has had "test service" only. Appearance is like new. Here is the buy of a lifetime.

Send Your Order by Telegraph or Air-Mail

## SCR-274-N COMMAND SET. 2 TRANSMITTERS & 3 RECEIVERS



### ALSO INCLUDES MODULATOR

• 6 Units, as illustrated, 4-5.3mc BC-457A and 5.3-7mc BC-458A transmitters, 1 each, 3-6mc BC-454A, 100-550kc BC-453A, 6-9.1mc BC-455A Receivers, 1 each. Also BC-456A Modulator Unit. Our price of \$34.95 includes all of the tubes required, as well as four dynamotors, control box and Antenna Tuning Unit with 0-10 Meter and 5µhf. vacuum condenser.

**ORIGINAL COST OVER \$600.00. TUBES ALONE WORTH OVER \$40.00  
OUR PRICE FOR THE COMPLETE COMBINATION . . . . . ONLY \$34.95**

Units also sold individually, as follows:  
BC-453B Revr. 190-550Kc, with tubes, \$8.95. BC-454 Revr. 3-6 Mc. with tubes, \$5.95. BC-455 Revr. 6-9 Mc. with tubes, \$5.95.  
BC-457A Xmtr. 4-5.5 Mc. with 4600 Kc Xtl & Tubes \$9.95.  
BC-458A Xmtr. 5.7-7 Mc. with 6200 Kc Xtl & Tubes \$9.95.  
DOTII Xmtrs and shock mounting rack \$18.95. Dynamotors, 28v for Revr. only \$1.95 ea. Current Meter 0-10 (2") \$1.95.

## HEAVY-DUTY ALL-PURPOSE 6L6 PUSH-PULL AMPLIFIER

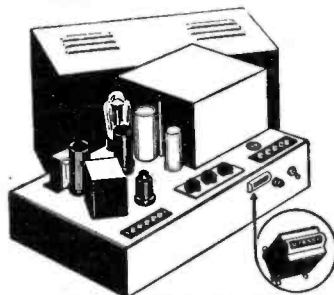

SUITABLE FOR—Wired Music, Coin Phonographs, Home Phonographs, Amusement Parks, Carnivals, Sound Trucks, Schools & Churches, Public Address, Etc.

### LICENSED BY WESTERN ELECTRIC FOR USE IN P. A. SYSTEMS AND PHONOGRAPHS

• These brand new Amplifiers in factory-sealed cartons are a Manufacturer's over-run. JUST COMPLETED! Parts alone cost more than full price of the amplifier. Standard RCA tubes (2-6L6, 1-6SL7, 1-6C5, 1-5U4G). Input for crystal or magnetic pickup, 600-ohm telephone line, and microphone. Separate Bass and Treble controls. Volume control. Output for standard 8-ohm speakers. Relay operated COUNTER (10,000 count) for coin-machine plays. Heavy duty power supply. Gray cracked case with lid. 10"x17"x9". A big, lousy job. 15 watts output 110-120 volt 60 cycle AC operation. Complete with all tubes and wiring diagrams. This is one of the greatest bargains ever offered.

ONLY  
**\$49.50 NET**  
List \$147.50

### SMALL PRECISION LATHE



110-V. A.C.  
WITH  
MOTOR

\$58.50 List  
NOT SUR-  
PLUS—but a  
brand new  
post-war  
product. A  
small lathe  
for radio  
shops, jewel-  
ers, laborato-  
ries, dentists,  
hobbycraft-  
ers, model  
makers, ma-  
chine shops,  
schools, etc. Automatic Feed. Work capacity 3" be-  
tween centers. Swing over bed 2". Constructed of  
steel and cast iron. Accurately machined and fin-  
ished. Fan-Cooled Motor mounted inside the base.  
Complete with 1 1/4" face plate, 2 lathe centers, tool  
post and rocker. 4-jaw chuck available at \$11.50  
additional. Drill chuck \$5.50 additional. Orders filled  
in rotation. Deliveries now.

### QUANTITY DISCOUNTS TO DEALERS

### SCR-522 VHF XMTR-RCVR.

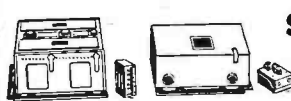

**\$34.50**

• 100-156Mc Transmitter-Receiver for Amateur, Civilian, Commercial and Airborne or Mobile Service. One of the most versatile surplus items—can be operated by anyone. 4 crystal-controlled channels, push-button operation, fixed frequencies. Transmitter output 15 watts. Transmitting tubes include 1-6G6G, 1-6SG7, 3-12A6, 2-823. The 4-channel superheterodyne receiver uses 10 tubes, as follows: 1-9002, B-9003, 3-12SG7, 1-12C8, 1-1235, 1-12AH7G. The dynamotor power supply is included in the purchase price. Control box and other accessories also supplied. Operation is from 28v DC, but can be converted for AC operation, simply and easily. Get one of these SCR-522 sets NOW, while stock lasts. A GREAT BUY!!

### World's Lowest Priced Brand New Surplus TELEGRAPH KEYS

Mounted on Black Bakelite Base. One of Best Keys Made for U. S. Army Signal Corps. (In sealed cartons.)

**4 FOR ONLY \$1.00**

(Include Postage for 5 Pounds)

These Keys list for \$2.75 each. You get \$13.75 worth of equipment FOR ONLY ONE DOLLAR!



### SENSATIONAL BC-348 RECEIVER

200-500kc and 1.5 to 18mc in six bands! Crystal I.F. Filter. 2 Stages RF. Combined RF and AF Gain Control. High-ratio Vernier Tuning Dial. Built-in 24v dc Dynamotor which is easily removable for AC pack installation. Two phone jacks on front panel, one for loud-speaker operation. Has 2 stages transformer-coupled audio. BFO Manual or automatic volume control. This is the most wanted surplus item. Limited stock. First come, first served.

**OUR PRICE \$49.50, Complete With 8 Tubes**

• We Can Also Supply This Same Receiver With Built-In 110 v. AC 60 Cycle Power Pack—Ready For Operation . . . . . \$69.50  
BRAND NEW BC-348 IN ORIGINAL FACTORY CARTONS, GUARANTEED USED, WITH TUBES AND DYNAMOTOR . . . . . \$59.50  
BRAND NEW 110 V. A.C. MODEL . . . . . 79.50

### ONLY A FEW LEFT

**BC-645 . . . . . \$16.85**

This 15-tube set will operate on frequencies for Citizens' Radio, Amateur, etc. Tubes alone worth \$25.00 net. Too well known to require description. Be safe, Order yours TODAY!! Our Price . . . . . ONLY \$16.85 Two for Only . . . . . \$30.90

12/24V. DYNAMOTOR-PE-101C. SUPPLIES ALL POWER FOR BC-645. 400V. 135MA. DC. ALSO 9V. 1.2A. AC. ONLY \$9.95 NET

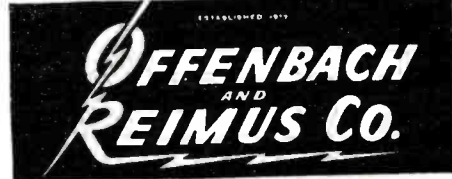

372 Ellis St., San Francisco 2, Calif.  
TELEPHONE: Ordway 8551  
We ship C.O.D. anywhere. Send 20% Deposit.

# All the Science of BASIC RADIO- ELECTRONICS in one 3½ lb. book



**ONLY  
\$5**

Complete

WRITTEN FOR  
**BEGINNERS**

## 36 COURSES IN ONE

If this big 972-page Book were broken into monthly lessons and sold as a "course" you'd regard it as a bargain at \$50 or more!



A. A. Ghirardi's famous 972-page, 3½ lb. RADIO PHYSICS COURSE book with its 500 illustrations and 856 Self-Test Review Questions can teach you basic Radio-Electronics quicker, easier and at far less cost

### START NOW!

than you may have thought possible! It has given more people their start in Radio than any other! It is used more for home study and was more widely used in U. S. Army Signal Corps and Navy war-time training programs than any other book of its type!

### LEARN IN A FEW WEEKS!

RADIO PHYSICS COURSE is written for beginners who want to learn at home in spare time. Many who never even studied a circuit diagram before have completed it in a few weeks. Every basic subject is fully covered. Nothing is omitted. You'll be pleased how quickly it has you understanding subjects that other books and courses make seem too complicated. Send coupon today! Our 5-DAY MONEY-BACK GUARANTEE protects you absolutely.

**"Better than a  
\$150 Course!"**

"I had already taken a \$150 radio course," writes Gerard Champagne of Montreal, "but since reading RADIO PHYSICS COURSE, I put the other one away. Ghirardi's is the book I need because it teaches so clearly!"

### NO RISK COUPON mail today

Dept. RM-97, Murray Hill Books, Inc.,  
232 Madison Ave., New York 16, N. Y.  
Enclosed find \$5 (\$5.50 foreign) for a copy of Ghirardi's 972-page RADIO PHYSICS COURSE book; or send C.O.D. for \$5 plus postage (no foreign C.O.D.'s). In either event, if not satisfied, it is understood I may return book in 5 days for complete refund of my money.

Name .....

Address .....

City & Dist. No. .... State .....

**YOU'LL NEVER GO WRONG  
on a GHIRARDI BOOK!**

a very important thing to watch is the proper orientation of each socket. Any mistake in the positioning of the key of the octals or the blank section of the seven contact miniature sockets will cause undue confusion and possibly poor results later.

Sockets having a tin plated mounting ring below the chassis are ideal for the frequent ground connections used in wiring. If no such ring is used, short ground lugs will be required at each socket mounting bolt.

The terminal strips can be bolted or riveted in place as indicated in the picture. Secure grounding of the mounting lugs is important for they will serve as ground connections for numerous circuits.

The power transformer should be mounted next, with its 110 volt primary leads brought through the rear clearance hole. Since the power transformer is the same height as the front panel, it serves as a convenient stand while the chassis is inverted for assembly.

While the can type electrolytic condenser can be mounted right after the power transformer is in place, the filter choke should be withheld until wiring is completed beneath it. The two small audio type blocking oscillator transformers,  $T_1$ , and  $T_2$ , can next be mounted, taking care that the low frequency unit,  $T_2$ , is nearest the front of the chassis and next to  $V_1$  socket.

After adding ground straps to the controls requiring them, as indicated in the schematic, all but the audio volume control may be mounted in place. Care should be taken to get the correct value control in its respective position and here a close check on the photograph will reveal the control number as well as the position of its terminals. The audio control ( $R_{50}$ ) with the power switch attached, should be treated as a sub-assembly by mounting  $C_{10}$  across its outside terminals and attaching  $C_7$  before the control is installed.

While the oscillator tuning condenser  $C_{11}$  can be mounted with the first group of controls, it will be found desirable to make a subassembly of the channel switch and let the mounting wait until one of the last operations.

There are three different kinds of intermediate frequency transformers, so they must be placed as identified. The first i.f. transformer,  $T_1$ , follows the mixer and through mutual coupling supplies the 21.25 mc. signal for the sound channel. The secondary of this transformer is a trap circuit and as such keeps the sound i.f. signal out of the picture i.f. channel. In keeping with the need for short lead lengths in these circuits, it is important that terminal "A" of this transformer face the back of the chassis and terminal "D" face the front.

The second sound i.f. transformer,  $T_2$ , is similarly mounted between sockets  $V_4$  and  $V_5$ .

After  $V_5$ , the discriminator transformer,  $T_3$ , must be mounted with its

## MORE FOR YOUR MONEY

### PHONO AMPLIFIER

3 Tube A.C.-D.C.

Volume and Tune controls; approx. 2.5 Watts output; uses 12SK7, 50L6, 3Z25



Kit Form .....	\$2.35
Completely wired and tested .....	2.85
Kit of 3 Tubes for above 12SK7, 50L6, 3Z25 .....	1.95
5" ALNICO P.M. SPEAKER .....	1.45
50L6 OUTPUT TRANSFORMER .....	.55
SHURE GLIDER CRYSTAL PICKUP .....	1.95
ASTATIC L-70 CRYSTAL PICKUP .....	1.95
ALLIANCE PHONO MOTOR .....	3.25
RECORD PLAYER—ATTACH TO ANY RADIO, ALLIANCE PHONO MOTOR, A STATIC CRYSTAL PICKUP, WALNUT FINISH CABINET .....	8.95
PORTABLE RECORD PLAYER KIT—3 TUBE PHONO AMPLIFIER, ALLIANCE PHONO MOTOR, A STATIC CRYSTAL PICKUP, 5" ALNICO P.M. SPEAKER, SIMULATED LEATHER CARRYING CASE .....	17.95
ASSEMBLED AND TESTED .....	21.50
RECORD PLAYER KIT—Same as above but with WALNUT FINISH CABINET .....	15.50
ASSEMBLED AND TESTED .....	17.75
MAGUIRE AUTOMATIC RECORD CHANGER .....	13.95
V.M. AUTOMATIC MIXER-CHANGER .....	17.95

All Prices F.O.B. Our Warehouse N. Y.  
25% Deposit Balance C.O.D.

## RAYTONE ELECTRONIC COMPANY

25A Frankfort St. New York 7, N. Y.

## HI VOLTAGE



Model 6  
**TELEVISION**

Power Supply  
4000-6000  
Volts D.C.

**\$17.95**

**KILOVOLTER** A Safe, Economical Source of Hi Voltage.

Wt. 2 lbs. Size 4"x6"x6"

Send Check, M. O. or See Dealer

Write for Folder

**C-B MFG. CO.**

412 W. 37th St. New York 18, N. Y.

## THE BARGAIN BASEMENT

Compare Our Prices!

Electronic equipment listed below are choice government surplus items in excellent condition. Ask for flyer on items not shown.

0-1MA DC Weston 301 3½" New .....	\$ 4.95
0-115MA RF Weston 425 3½" New .....	4.95
0-20 KV DC Westinghouse, 0-1 FS 3½" .....	3.25
Supreme Multimeter 542, 16 ranges leads .....	12.95
Oscilloscope Dumont 164E 3". A Real Buy .....	54.95
50 assorted condensers, Mica, paper, etc. .....	2.29
Panel lamps Mazda No. 47, 6v, Brown Bead. Box of 10 .....	.51
Kit of 100 ½ watt popular resistors .....	1.89
5" Scope BC 126B, 24 tubes including 5CP1 part of SCR 545 IFF .....	18.50
Precision resistors 5000 ohms, 1%, 3 for .....	.29
4mfd 500Vw paper cond. lug terminals, metal case .....	1.19
Rotary beam brake, dry oilite disc type, heavy duty, lever control .....	1.98
2 Meter beam elements, copper plated tubing ¾" OD .....	.10
For your Rotary beam, steel pipe braces, Instructions .....	.89
Aluminum cans 8x5x1 ¾" .....	.20

FOB Baltimore. Minimum Order \$2.00

## EASTERN ELECTRONICS SALES

31-B Cedar Drive Baltimore 20, Maryland

terminal "A" toward the back of the chassis and "E" towards the front.

The three identical picture i.f. inductances should be mounted so that the lead from the bottom end of the winding on the first two ( $L_3, L_4$ ) faces the front of the chassis and for  $L_5$ , to the rear of the chassis.

#### Wiring Procedure

From the pictures and the associated data following the mounting of basic components, it is apparent that the socket grounds, a group of bypass condensers and independent resistors are wired in place to form the first of a number of layers used in the construction procedure.

Interconnecting wires and subsequent parts are named in an order which permits a gradual folding together of the second and third layers in actual construction. In following this sequence, therefore, no difficulty should be experienced from overlapping of snugly placed parts.

Since short leads are essential to good high frequency performance it is advisable to copy the photographs as closely as possible and thus take full advantage of the careful planning necessary for the successful mounting of critically placed parts.

Where heat is to be dissipated from certain resistors, it will be noted that they are allowed a fair amount of clearance from neighboring parts. This accounts for the 1 watt screen resistors being mounted in the final layer of construction and their being kept about one inch from the chassis. Warmed air rising from the larger resistors will naturally circulate towards the ventilation holes provided in the top of the chassis.

In order to take full advantage of the layer construction, a definite sequence of mounting wired parts must be followed. The first step is to ground all center eyelets of the miniature sockets with tinned copper wire. While doing this the grounded socket terminals can also be included and a check of the schematic will indicate which terminals require grounding. All number 3 miniature socket terminals can be connected together with an insulated green wire for filament current distribution.

We are now ready to mount the ceramic bypass condensers, which should be laid close to the chassis and exactly as shown in the picture. Use the following order:  $C_{20}, C_{16}, C_{23}, C_{27}, C_{21}, C_{11}, C_{17}$ . The next few are to be mounted on a 60 degree angle as shown and they are:  $C_{15}, C_{22}, C_{28}, C_{20}, C_{18}$  and a combination,  $C_{19}$  and  $C_{10}$ .

The first group of resistors, some mounted on a 45 degree angle and some mounted vertically follow:  $R_1, R_2, R_{18}, R_{27}, R_{21}$ .

Mount  $R_{11}$  between pin 2 of socket V, and the fourth point from the front on terminal strip 2. A yellow wire connects the latter point with the contrast control.

Next wire a portion of the audio system:  $R_{20}, R_{10}, C_{12}, R_{11}$  and  $C_{12}$ . Also

September, 1947

# new

## CONCORD

## Radio

## Catalog



### Radio Parts Radio Sets Ham Gear Amplifiers

**free**  
Radio Hams • Servicemen • Engineers  
Sound Men • Maintenance Men  
Schools • Institutions • Manufacturers  
**THIS CATALOG IS FOR YOU!**  
*Mail COUPON TODAY!*

### Industrial Electronic and Test Equipment

It's here—ready for you now—the new, comprehensive, 1947 Concord Catalog displaying a vast, complete selection of everything in Radio and Electronics. Send for your copy now. Select your needs from value-packed pages showing thousands of items available for IMMEDIATE SHIPMENT—hundreds of them now available for the first time—featuring new, latest 1947 prices. See the new LOWER prices on finest-quality RADIO SETS, PHONO-RADIOS, RECORD CHANGERS, RECORD PLAYERS, PORTABLES, AMPLIFIERS, COMPLETE SOUND SYSTEMS, TESTERS. See complete latest listings of all the well-known, standard, dependable lines of radio parts and equipment—tubes, condensers, transformers, relays, resistors, switches, speakers—all available for IMMEDIATE SHIPMENT from huge stocks in CHICAGO and ATLANTA. Whatever your needs in Radio and Electronic Parts, Supplies and Equipment—before you buy—SEE THIS GREAT NEW CONCORD CATALOG. Mail coupon for your FREE copy now.



**TIME-PAYMENT PLAN**  
Buy your Radio and Electronic Equipment from Concord on EASY PAYMENTS—Communication: Receivers, Transmitters, Radios, Radio-Phonos, Sound Equipment, Test Equipment. Write us your needs.

**WANTED TRADE-INS ON COMMUNICATIONS EQUIPMENT**  
Depend on Concord too, for highest trade-in values on communications receivers and transmitters. Write, phone or call to tell us what you have—or send it in for free appraisal.

**CONCORD**  
RADIO CORPORATION  
CHICAGO 7 ★ ATLANTA 3  
901 W. JACKSON BLVD. 265 PEACHTREE ST.  
LAFAYETTE RADIO

Concord Radio Corporation, Dept. E-97  
901 W. Jackson Blvd., Chicago 7, Ill.  
Yes, rush FREE COPY of the comprehensive new Concord Radio Catalog.

Name .....

Address .....

City ..... State .....

\$351<sup>00</sup>  
VALUE

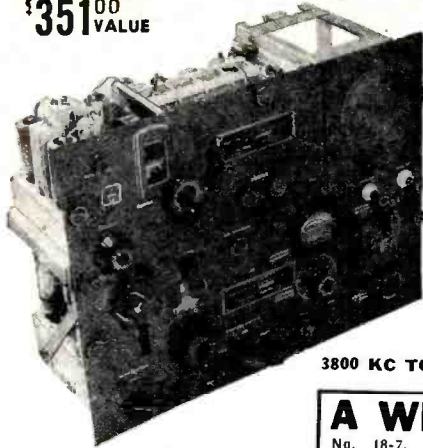

# RECEIVER EXMITTER

## FREE

A COMPLETE SET OF  
TRANSMITTING AND  
RECEIVER TUBES  
WORTH \$35.00

FREE 1-200 KC CRYSTAL

BC-654-A is a combined transmitter and receiver designed for portable or vehicular operation. The frequency range of both transmitter and receiver is continuous from 3700 to 5800 kilocycles; all stages are tuned by anti-back lash worm gear dial mechanisms.

25 WATTS  
POWER  
COVERS  
3800 KC TO 5800 KC

YOUR PRICE **\$14.<sup>50</sup>**

### A WIRE BUY

No. 18-7. Strand Black Plastic Vinylite Indoor or Outdoor Wiring on 27" reel—15,000 ft. \$27.00 Value. Your Price. **\$33.00**  
Lifetime Covering 100 Uses

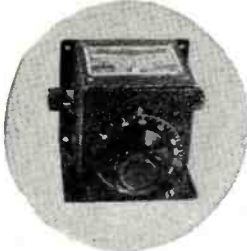

### FREQUENCY METER

Calibrated on Vernier Dial 80- to 500-Meg.  
\$25.00 Value. Your Price. **\$4.95**  
In Lots of 10—\$4.50

### HEAVY DUTY POWER TRANSFORMER

"The Buy of the Year"  
3 Primary Windings  
110v — 120v — 125v  
Taps on Primary  
65-70-72v.  
Secondary Windings of  
500v — 5v — 6.3 volts  
Size 4¼x4¼x3¼  
**NOW ONLY \$3.95**

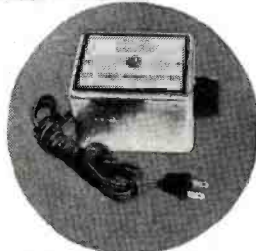

MALLORY LINE NOISE FILTER  
Rating 110-220 V. (AC-DC)  
\$10.00 Value.  
Your Price. **\$3.75**  
In Lots of 10—\$3.25

All Prices F.O.B. N. Y. C.—20% deposit, Bal. C.O.D.

## MANUEL KLEIN

74 CORTLANDT STREET  
NEW YORK 7, N. Y.

## SURPLUS SPECIALS

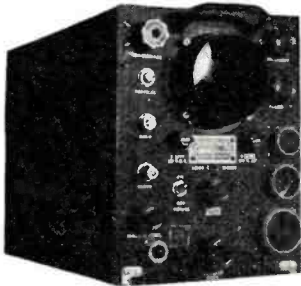

- Cathode Ray Scope, 3" radar indicator ID-93/APG-13A, 115 volts 400 cps, 10 tubes plus 3" cathode ray tube. Power supply and sweep circuit need modification to make fine scope. New, made by G.E. **\$25.00**
- RCA Cathode Ray Scope, model 160B, new, packed for export, **\$135.00**
- RCA Voltohmmeter, model 165, electronic volt ohmmeter, new, **50.00**
- RCA Beat Frequency Audio Signal Generator, 30-15000 cps, model 154, new packed for export **60.00**
- Radar Receiver BC 406, 15 tubes, 2 r.f. channels at 200 megacycles, 20 mc I.F., 115 volt 60 cps operation, well filtered power supply **25.00**

### METERS

- 0-1 Milliammeter, 3½" round, Westinghouse, white scale reads 0-350 volts, new **3.50**
- 0-3 Milliammeter, 3" square, Triplett, white scale reads 0-3 ma., new **3.50**
- 1-0-1 Milliammeter, 3½" round, Marion sealed meter, white scale reads 100-0-100, new **3.50**
- 0-1 Milliammeter, 3" square, white scale reads 0-1, 0-2.5, 0-5 ma., 0-500 volts, and 0-2.75 megohms, new **4.00**
- Dual 0-200 Microammeter, Westinghouse landing indicator, blank scale **3.50**
- 0-10 amps, 3" square meter, Triplett, white scale reads 0-10 amps, new **3.50**

### ELECTRO IMPULSE LABS.

P. O. Box 250 Red Bank, New Jersey

## SPECIALS for SEPTEMBER

### AERIAL WIRE

100 ft. coil, 7/23, tinned aerial wire **69c** each  
50 ft. coil (same as above) **36c** each

### PUSH-BACK WIRE

Solid or stranded, tinned copper conductors with cotton serve and waxed cotton outer braid for easy push-back; available in all standard colors.

Per 100 ft. coil— 22 Ga. Solid **61c**  
22 Ga. Stranded **68c**  
20 Ga. Solid **71c**  
20 Ga. Stranded **82c**  
Per 1000 ft. spool—22 Ga. Solid **\$5.72**  
22 Ga. Stranded **6.45**  
20 Ga. Solid **6.51**  
20 Ga. Stranded **7.38**

### 18 GAUGE SOLID FIXTURE WIRE

Solid, tinned copper conductor with weather-proof compound under lacquered braid; Type R.F. Underwriters Approved; a real buy at this low price:

**\$6.50** per 1000 ft.

We carry in stock for immediate delivery many types of wire and cable in gauges of from 23 to 2, in addition to various types of multi conductor cable for many uses. We also manufacture cord sets and cables to specifications. Send us your inquiries for prompt attention.

OUR NEW CATALOG IS NOW  
AVAILABLE FOR DISTRIBUTION  
Write for your copy today.

**COLUMBIA WIRE & SUPPLY CO.**  
5740 NO. ELSTON AVE.  
CHICAGO 30, ILLINOIS

following that:  $R_1$ ,  $R_2$  and a lead from pin 6 on  $V_{17}$  to  $C_{71}$ .

We are now ready to connect the i.f. transformers and add associated resistors and condensers as follows:  $C_{23}$ ,  $C_{45}$ ,  $R_{30}$ ,  $C_{48}$  and  $C_{52}$ .

Approaching the second detector and the synchronizing circuits add:  $R_{23}$ ,  $R_{20}$ ,  $R_{21}$ , the peaking coil, ( $L_{16}$ ),  $R_{23}$ ,  $R_{21}$ ,  $C_{35}$ ,  $R_{42}$ ,  $R_{37}$ ,  $C_{12}$ ,  $R_{19}$ ,  $R_{45}$ ,  $C_{55}$  and  $C_{56}$ .

Connect the four leads, by colors indicated on the schematic, from each of the blocking oscillator transformers  $T_4$  and  $T_5$ . After that mount more parts in those circuits, namely:  $C_{62}$ ,  $R_{55}$ ,  $R_{53}$  and  $R_{65}$ .

The speaker and output transformers can next be mounted and wired in place. After that the two high voltage condensers,  $C_{63}$ ,  $C_{67}$ , can be bolted down and wired also.

By this time the leads from both the cathode-ray tube socket and the power transformer can be dressed into place and connected. After that mount the filter choke  $CH_1$  (labeled  $L_7$  in the photograph) and the power cord but *do not apply power* until the set is completed.

The rest of the assembly is straightforward except that the connections for coils  $L_3$ ,  $L_4$  and  $L_5$  should precede the installation of the coupling condensers  $C_{25}$ ,  $C_{29}$ ,  $C_{33}$  and the screen resistors  $R_9$ ,  $R_{13}$  and  $R_{17}$ , which, incidentally, should clear the chassis by about an inch.

Considerable care should be exercised in placing the oscillator coil. It must be mounted on the lugs of  $C_{13}$ , the tuning condenser, exactly as shown.

The antenna coil is mounted by its leads to the number one terminal of socket  $V_2$  and an immediate ground point at the base of that socket.

Mixer coupling is affected by twisting the insulated grid wires of  $V_1$  and  $V_2$  together.

If the receiver is to be used in an area served by channels 1, 5 or 6 the following additional condensers, *not mentioned in the parts list*, will enable it to tune to these channels.

Channel I—add  $C_7$  (27  $\mu$ fd.) between first terminal and ground on  $S_{1A}$ .

Channel I—add  $C_7$  (12  $\mu$ fd.) between first terminal and ground on  $S_{1B}$ .

Channels V and VI—add  $C_5$  (3.3  $\mu$ fd.) between fifth terminal and ground on  $S_{1A}$ . No additional condenser is required on the fifth terminal of  $S_{1B}$ .

### Inspection and Test

Before turning on a newly constructed receiver, it is wise to give it a thorough visual inspection and then to test the step-by-step operation of various circuits to assure safe over-all performance. **DO NOT APPLY POWER DURING VISUAL INSPECTION.**

Connections for each part, each socket terminal, and all wire colors must be verified for compliance with the circuit diagram or construction photos.



The high voltage circuit including power transformer leads, rectifier tube socket connections, high voltage condensers, brightness and focusing controls as well as the series resistors in that circuit, must all have at least  $\frac{1}{8}$  of an inch clearance between un-insulated metal parts and ground.

After completing the visual inspection it is advisable to make a check of the resistance to ground of both of the power supply circuits. The filament contact of the low voltage rectifier and the plate connections of the high voltage rectifier should both show a high resistance.

The power line plug connections should show an open circuit to ground.

With the power switch on and with a d.c. ohmmeter across the power plug terminals, a reading of three ohms should be indicated.

The next step is to check the type number of each tube to be sure that it is in its proper place.

The cathode-ray tube can be mounted in position with the base well seated in its socket but *both rectifier tubes should be removed from the set for the initial trial under power.*

With the set right side up, plug the power cord into an 110 volt, 60 cycle a.c. outlet and then turn on the switch. Note first the orange color glow of the filaments in the miniature tubes and near the base of the cathode-ray tube.

When the filaments are all known to light satisfactorily, (by heat emission in cases where no light is visible) the next step is to plug the high voltage rectifier tube into its socket. This should be done with the power turned off.

Within about 15 seconds after turning the power on again, a spot of light should appear on the cathode-ray tube screen. If it does not, observe first the plates in the rectifier tube for a possible dull red glow. This will indicate trouble in the high voltage circuit and is reason enough to disconnect the power source at once and proceed with a check-up on the entire high voltage circuit. *Be sure to short circuit the high voltage filter condenser before making other tests or touching any part of the wiring.*

Should the spot fail to appear with the rectifier tube acting normally, adjustment of the "Brightness" control should follow. It is possible that the spot could be off screen and for this reason both "Vertical" and "Horizontal Centering" controls should be turned through their range.

Operation of the "Focus" control is the next thing to check and this should result in variation of the spot size. Do not allow the spot to remain on or in one position longer than a few seconds as it may burn the screen material and result in permanently poor illumination at that point.

If everything is performing well so far, then the next step is in order, and the low voltage rectifier tube can be inserted in its socket. Like the

# TRANSVISION SCOOP!

**NEW! SENSATIONAL!**  
**12" TELEVISION KIT by TRANSVISION**  
*It's TOPS IN TELEVISION VALUE!*

*Again!* **TRANSVISION** leads the field  
 with this magnificent 12" Television Kit!

*Engineered for Easy, Rapid Assembly*

**SEE IT!**  
**HEAR IT!**



The great performance of this superb set will shatter all your previous conceptions of television quality and value.

**It's the Tops in Television**

This new 12" Kit is available in two models:

**STANDARD MODEL:**

- Has 12" Picture Tube (magnetic type)
- Picture size 75 square inches, (7 $\frac{1}{2}$ " x 10")
- Receives all television channels now on the air with provision for Transvision factory to add new channels at no extra cost (except shipping charges)
- 4mc band width for full picture definition
- 9000 volts second anode potential for brightness and contrast
- 3 stages picture I.F.
- 2 stages pre-tuned and aligned I.F. coils
- Ratio detector for sound provides High Fidelity F.M. Sound Reproduction
- 22 tubes and 12" picture tube
- Maximum picture sensitivity (approx. 50 microvolts)
- Stabilized synchronizing circuits to minimize interference on picture
- Overall chassis size 24" wide x 18" deep x 4" high
- Finest quality pretested parts throughout
- Complete with SPECIALLY DESIGNED Folded Di-pole Antenna and 60 feet of lead-in cable

**DE LUXE MODEL WITH BUILT-IN F.M. RADIO:**

Complete with all tubes, Folded Di-pole Antenna, and 60 feet of lead in cable. Has the same features as the Standard Model described above, plus the following

**ADDITIONAL FEATURES:**

- 50-216mc continuous tuning including F.M. band and 13 television channels.
- Switch provided to cut off unused tubes when used as F.M. receivers.

**BEAUTIFUL FURNITURE-FINISH CABINET.** Available at extra cost.

*See your local distributor, or for further information write to:*

**TRANSVISION, INC., Dept RN, 385 North Ave., New Rochelle, N.Y.**

# IF IT'S IN RADIO Resco Has It!

## TELEGRAPH KEY SPECIALS



Check these amazing low prices and pick yours now while they last.

J 37—Solid Coin Silver Contacts, Bakelite Base .....	29c
J 38—Same, but with Circuit Closer (slightly used) .....	39c
J 38—Brand New .....	69c
McElroy 200 (shown)—Built for highest standards. Black crackle finish. Less Circuit Closing Switch .....	79¢

## AMPHENOL POLYSTERENE

12" x 16" Sheets		8" x 4" Sheets	
1/16" thick	1.44	1/16" thick	17c
3/32" thick	2.22	3/32" thick	20c
1/8" thick	2.78	1/8" thick	24c
3/16" thick	4.11	3/16" thick	30c
1/4" thick	5.56	1/4" thick	40c
Tubing—1 Ft. Lengths		Rods — 1 Ft. Lengths	
3/8" O.D.	11c	1/4" diam.	8c
1/2" O.D.	14c	3/8" diam.	17c
5/8" O.D.	19c	1/2" diam.	31c
3/4" O.D.	23c		
1" O.D.	31c		



## FILTER CAPACITOR SPECIALS

All standard brands, rectangular cans, oil filled.

2 mfd. 600 WVDC	.95
4 mfd. 600 WVDC	1.45
1 mfd. 1000 WVDC	.79
2 mfd. 1000 WVDC	1.95
4 mfd. 1000 WVDC	2.95
8 mfd. 1000 WVDC	3.75
2 mfd. 2000 WVDC	2.95
2 mfd. 4000 WVDC	4.95
.1 mfd. 2000 WVDC	.95
.01 mfd. 6000 WVDC	.95

Round can capacitors with center terminal

.03 mfd. 7500 WVDC	.95
.1 mfd. 7500 WVDC	.95

## MICA CAPACITORS

.056 mfd. 1000 VDC	79¢
.024 mfd. 1000 VDC	
.033 mfd. 1500 VDC	

## TRANSFORMERS

HIGH-VOLTAGE. T8 —	LOW-VOLTAGE. T9 —
2200 Volt 2 ma. Separate 2.5 Volt 2 Amp. Winding. (2500 VDC at filter) .....	385-0-385, 200 Ma., Separate 5 Volt 3 Amp., Separate 6.3 Volt 5 Amp., Separate 6.3 Volt 5 Amp. ....
7.95	8.50

## POWER TRANSFORMER

Fully cased with lug terminal on bottom.  
Primary 110 V 60 cycles, 680 V, CT at 150 ma. 6 V at 2 amp. 10 V at 10 amp. **3<sup>95</sup>**

Write for free descriptive folder of RCA Television Components and Typical Diagram

## SPECIAL BULLETIN OF VALUES ON RADIO PARTS AND EQUIPMENT

Send for Yours Today!

Include Postage with Cash Orders

# Radio Electric

SERVICE CO. OF PENNA., INC.

7TH AND ARCH STREETS, PHILA. 6, PENNA.  
Branches: 5133 Market St. and 3145 N. Broad St. in Phila.  
Also in Wilmington, Del., Easton, Pa., Allentown, Pa., Camden, N.J.

other rectifier, it too must be watched for red glow on the plates, which is a sign of too much current drain. As the rectifier warms up and the deflection oscillators start to function it will be noticed that the light spot on the screen will suddenly swing into motion producing an over-all illumination of the screen area or some rectangular part thereof. It may be necessary to increase the brilliance to observe this change.

### Alignment

The following equipment is required for alignment: 1. A radio frequency test oscillator or signal generator with a range up to at least 30 megacycles; 2. A high resistance voltmeter, preferably of the vacuum tube type with a low range scale of at least five volts; 3. Insulated alignment screw driver.

Signals can be injected into the #1 grid of the mixer tube  $V_2$  by clipping on to the station selector switch-arm to grid lead and grounding the test oscillator at the front of the chassis.

For picture i.f. alignment the meter should be connected to the video detector output, pin #7 on  $V_6$  and set to read negative voltage. The contrast control must be turned to maximum output position during the following procedure.

With a 23.75 mc. amplitude modulated signal applied to the mixer grid, introduce enough signal to obtain a fair meter deflection. The mixer plate tuning adjustment ( $T_1$ , upper screw) should then be set to produce a maximum output indication. The same frequency is likewise used in tuning the last picture i.f. coil,  $L_2$ .

After these two adjustments are completed the test oscillator should be reset to produce 25 mc. so that frequency can be used to set the next to the last video i.f. coil,  $L_3$ , for maximum output.

The test oscillator should again be reset, this time to supply a 25.75 mc. signal which is used in adjusting the remaining picture coil  $L_3$ , to maximum output. Any sudden full scale deflection of the meter is a pretty sure indication of oscillation within the i.f. channel and is often due to coupling of attached test leads. Rearrangement of the leads or slight detuning of the affected stage will help to overcome this condition.

With a modulated signal applied, a horizontal bar pattern will be shown on the cathode-ray screen, if the video amplifier stage is working properly. This serves as a test for the video amplifier and for the vertical synchronizing circuit inasmuch as the bars will remain fixed by virtue of synchronizing control.

A crude check for bandwidth response can be made by varying the test oscillator through the region of 20 to 27 mc. while observing the bar intensity or the meter deflection.

Applying a 21.25 mc. amplitude modulated signal, adjust the sound i.f. transformer cores ( $T_3$ ,  $T_2$ ,  $T_1$ , lower) for maximum output from the

LEARN NOW!

# ELECTRONICS

- RADIO
- F.M. and TELEVISION
- PUBLIC ADDRESS SYSTEMS
- SHORT WAVE COMMUNICATIONS

Men! Women! Find successful careers in this fascinating field! Ample equipment for all to use in practical classes. *You start practice when you enroll!*

## Approved for Veterans HOLLYWOOD SOUND INSTITUTE

1040 N. Kenmore Ave., Dept. A  
LOS ANGELES, CALIF.

Order and Save!

## The WALMAR Way!

### CONDENSERS

Oil Filled C. D.—Aerovox	
2X.5 @ 600v.	25, 25, 2X.1, 50.27
C.D. Type TJH 1 mfd 2000v.	1.35
C.D. Type TJH 4 mfd 2000v.	1.85
C.D. Type TJH 8 mfd 1000v.	1.75
C.D. Type TJH 10 mfd 600v.	1.55
C.D. Type TJH 10 mfd 1000v.	1.90
Mica .05 mfd 3000v.	.35
Mica .03 mfd 1000v.	.25

### RESISTORS

1.5 meg. 1.5 KV Precision Meter Multiplier	
Weston	\$1.75
100 Insulated AB type & Erie 1/2, 1 & 2 Watts	
Ass't.	2.25
500 ohm 50 Watt IRC Rheostat	.85
300 ohm 50 Watt IRC Rheostat	.75
3000 ohm 50 Watt IRC Ohmmeter Model K	1.30

### RELAYS

24v. DC SPST N/O G.E.	50.75
28v. DC DPDT Allied Control	.85
115v. AC Relay Assy G.E. 4 relays on panel	1.65
Relay shunting chokes	2.55
115v. AC DPST Dumco 30 amp. contacts	2.15

### COILS

R.F. Inductance coils G.E. on coil form	\$0.85
Z-O, R. F. plate chokes	.10

### TUBES — FULLY GUARANTEED

705A	2.85	801A	1.75	5CP1	5.10	708A	52.95
802	1.65	803	8.95	5HP4	5.25	715A	4.35
448A	2.85	807	.85	835	5.25	715B	4.35
6K7	68J7	68S7	128Q7	6C5			.73
6BE6	6G6	6SN7	12SH7	128G7	68G7	68C7	.78
5U4	6C8	6D8	68A7	68K7	128A7	6J5	.65
6A6	6L7	6R7	68L7	6Y6	2050	955	.956
2A3	6AC7	6B8	12C8	2X2	2051	6V6	6AB7
115v. AC Navy Type used with transmitter							.85
TBL-2 to TBL-5. Manufactured by RCA—							
complete with tubes							63.00

ALL PRICES F.O.B. BALTIMORE

**WALMAR DISTRIBUTING CO.**  
3803 Beehler Ave., Baltimore 15, Md.

## LEARN RADIO!

IN ONLY 10 MONTHS  
**PREPARE FOR A GOOD JOB!**  
BROADCAST ENGINEER  
COMMERCIAL OPERATOR (CODE)  
RADIO SERVICEMAN

Television Servicing—15 Months

(Approved for Veterans)  
SEND FOR FREE LITERATURE  
**BALTIMORE TECHNICAL INSTITUTE**  
1425 EUTAW PLACE, BALT. 17, MD.

RADIO NEWS

NEVER BEFORE AT THESE  
LOW PRICES

# RADIO PARTS BARGAINS

LIMITED QUANTITIES  
HUGE SAVINGS

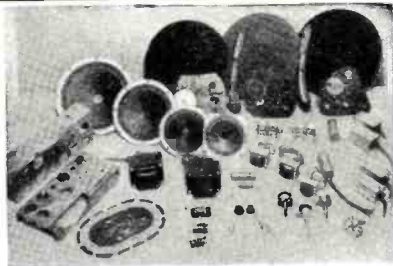

Don't Pass These Up—  
All for Immediate Shipment

AC—Alliance Phono Motors with Turntable	\$2.65;	case of 10.	\$24.50
AC—Ballantine Phono Motors with Turntable	3.25;	case of 10.	29.95
Astatic Curved Arm Crystal Pickup	1.50;	case of 10.	14.00
Shure Glider Crystal Pickup	1.50;	case of 10.	14.00
GE 12" Alnico 5 6.8 oz. Magnet PM Speaker	6.75;	case of 6.	36.00
ROLA 10" Alnico 5 PM Speaker Heavy Slug	5.75;	case of 6.	30.00
GI 8" Alnico 5 PM Speaker 2.8 oz. Magnet	3.25;	case of 6.	18.00
6" PM Speaker Special Alnico Heavy Slug	1.65;	case of 10.	14.00
5" PM Speaker Alnico Heavy Slug	1.20;	case of 10.	11.00
5" PM FAMOUS BRAND Alnico with 50L6 output trans.	1.59;	case of 10.	13.95
Cornell Dubilier 50X30 Aluminum Cap Self Support Leads	50.39;	10' for	3.45
Universal Output Transformer 8 Watt Single PP 4000 ohms to 14,000 CT	1.30;	10 for	11.00
Universal Output Heavy Duty 18 Watt Single PP 4000 ohm to 14,000 CT	1.55;	10 for	12.75
Single 50L6 Output transformer 3.5 ohm Impedances	.39;	10 for	3.50
1/2 Meg. Volume Control IRC with Switches	.49;	10 for	3.95
1/2 Meg. Volume Control Less Switch	.29;	10 for	2.45
10"x2" Punched Chassis Side Dial 4"x10"x2"	.29;	10 for	2.50
Superhet Variable Cond 420-165 MMF 2 GANG	1.10;	10 for	9.50
TRF VARIABLE Cond 420-420 MMF 2 GANG	1.25;	10 for	11.00
IP Coils Matched Set 456 KC Litz Wound Double Tuned	1.00;	10 for	9.00
High Gain Loop Antenna	.39;	10 for	3.00
90 MA Power Transformer 700V CT 6.3V 2 Amp	3.25;	10 for	27.00
70 MA Power Transformer 700V CT 6.3V 2 Amp	2.95;	10 for	23.00

## CUSTOM FM & BROADCAST RADIO CHASSIS

11 Tubes, 15 Tube Performance FM Band 88 to 108 MC. Manufactured by O. C. of the Leading Radio Factories

Exclusively for Us

Supplied Ready to Operate. Complete with Tubes, Folded Dipole and Loop Antenna Speaker (10" Rola) and all necessary hardware for mounting in cabinet. Chassis Dimensions: 31 1/2" wide, 9" high, 9" deep. Satisfaction Guaranteed or Money Back. Your Net Cost, \$94.00; Lots of 3 or More, \$84.60 Ea.

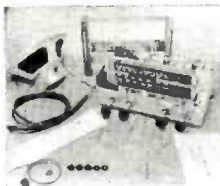

## CUSTOM 3 BAND 8 TUBE CHASSIS

Bdes't 535 to 1680 KC —2.2 to 7.2 MC—6.0—23.5 MC. Complete wired with tubes, Speaker, loop. All necessary hardware for cabinet mounting. Chassis Size 13 1/2" wide, 9" High, 9" Deep. Your Net Cost, \$66.50; Lots of 3 or More, \$60.00 Ea.

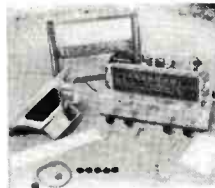

• Please Include 20% deposit with orders; balance C.O.D. Orders under \$10.00—remit in full.

• All Parts, Kits, Chassis are sold with our money-back policy, thus guaranteeing your complete satisfaction.

• No C.O.D. on Canadian and foreign shipments.

## AMERICA'S FINEST RADIO KIT VALUE

5 Tube AC-DC Superhet with Tone Control. Complete with Plastic Cabinet (D 1 m, 12 3/4" x 8 1/4" x 7 1/2"). Your choice of Colors: Brown, White, Blue, Rose, Green, Red, 3 Inch Alnico 5 PM Speaker, Matched High Gain IF's, 8 Pages of Pictorial Instructions, as used by many schools and Veteran Organizations. Anyone can complete. Chassis Assembled. Special, \$14.95, Less Wire and Solder.

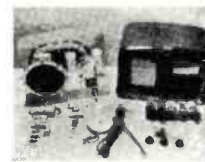

Matched Kit of RCA, Sylvania or N-U Tubes Included. Your Money Back if Not 100% Satisfied.

CABINET CHASSIS & DIAL ONLY \$2.95

Your Choice of Colors, same as above

## KIT SPECIALS

5 TUBE AC-DC Super Het. All Components Including Instructions —Less Tubes, Wire, Solder. 5" Alnico 5 PM Speaker, Litz IF's Loop Antenna. Fine Value. \$6.95; 10 for \$65.00.

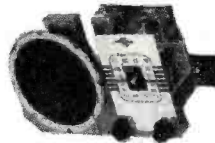

## TUNING ESSENTIAL KIT

2 Gang Super Variable Condenser. Matched Set IF Coils Litz wound. Loop Antenna. Oscillator Coil. Dial. Chassis. Special, \$2.95; Lots of 10.....\$27.00

## KNOB KIT

50 Asst. Popular Knobs.....\$1.95

Send for Confidential Radio Tube Price List. Lowest Tube Prices in the Country

# AMERICAN RADIO SUPPLY CO.

120 CEDAR STREET

::

NEW YORK 6, N. Y.

## Suburban Leads The Field With The "SUBRACO 75T"



A sensationally new medium power transmitter designed for compactness, dependability, and simplicity of operation. The "SUBRACO 75T" is capable of delivering 75-watts output of 100% modulated, undistorted carrier, with a frequency range covering from 3.5 to 30 megacycles.

A swinging link is used for antenna loading, matching anything from 20 to 600 ohms, the output, of which, is fed through two insulators at the rear of the cabinet.

The R.F. section consists of a 6V6 fundamental or harmonic oscillator, a 6L6 doubler or fundamental oscillator for frequencies below 7 megacycles, and an 828 as a power amplifier.

The modulator section consists of a 6SJ7, 6J5, 6V6, as speech amplifiers, driving a HY31Z in class "B." Any standard high impedance microphone can be used. Frequency response is plus or minus 3DB from 200 to 5000 cycles.

Power is obtained from three separate, self contained, supplies, consisting of a pair of 816's for the power amplifier, a 5R4GY for the oscillator and doubler, and an 83 for the modulator.

Metering is accomplished by a switch, located directly below the meter, enabling you to read: cathode current of the modulator, doubler grid, power amplifier grid, and power amplifier plate.

All controls, as well as the microphone connector, key jack, and external xtal jack, that is provided to facilitate rapid frequency change as well as the use of any standard "ECO," are located on the front panel.

A switch on the gain control of the modulator is used for changing from "CW" to "PHONE" operation. A "TRANSMIT-RECEIVE" switch simultaneously controls the transmitter, receiver break-in, and antenna change-over. A connector, providing receiver break-in connections, as well as an antenna relay, is supplied with the transmitter, connections for both being brought out at the rear of the chassis.

A "TUNE-OPERATE" switch is provided for tuning-up, frequency check, and to prevent possible damage to the power amplifier.

The "SUBRACO 75T" is completely self-contained in a modern crackle cabinet measuring 14" high, 15" deep, and 22 1/2" wide, weighing 200 pounds crated for shipment.

The "SUBRACO 75T" comes complete with all tubes, meter, one complete set of coils for the 10, 20, 40, and 80 meter bands, and one 7 megacycle xtal. "All you need is a mike, key, and antenna and you're on the air."

All "SUBRACO" transmitters are unconditionally guaranteed, excepting tubes, for a period of ninety days after purchase.

All transmitters are F.O.B. East Rutherford, New Jersey, and require a 20% deposit in continental U.S.A., 30% elsewhere.

PRICE \$296.50. IMMEDIATE DELIVERY OF A LIMITED QUANTITY

# SUBURBAN RADIO COMPANY

82 Herman Street

East Rutherford, N. J.

Cable Address "SUBRACO"

# For Better Buys See HIGHBRIDGE

## BRAND NEW 7EP4

Individually packed—in original cartons—Guaranteed..... **\$19.50**

### WESTERN ELECTRIC INPUT TRANSFORMER

Video core type; imped. ratio between windings: 1-2, 3-4, 5-6, in parallel 50-900 ohms; Freq. range 10KC to 2 MC; made for set AN/APQ-13; Electrostatic shield between windings, oil filled; 5% diameter, 5" high, wt. 5 lbs. .... **\$1.95**

KS-9524—Transformer Pri. 115 V—60 cycles. Sec. #1—450 V @ 30 MA C.T., Sec. #2—6.4 V @ 1250 MA. Rectangular metal case, stud mtg. solder eyes—approx. size 3 1/4" x 2 1/4" x 3 3/4" with stand-off 1/4". No. T2G-97. .... **\$1.95**

I.R. #7313 Filament Trans. 115 V—50-60 cycle. Sec. #1—27 KV @ 4.3 amps No. C.T.—Sec. #2—5.1 V @ 3 amp C.T.—Sec. #3—6.4 V @ 3 amp No. C.T.—Sec. #4—5.1 V @ 3 amp C.T.—Sec. #5—2.6 V @ 3.5 amps No. C.T.—Rectangular metal case, solder post terminals; Mtd. on porcelain stand-offs; stud mtg. size 5/8" x 1/4" x 5/8" with standoffs 6/16". T2E-88 ..... **\$4.95**

High voltage transformer with Glass Standoffs. Pri. 115 V. A.C.—400 cycle—Sec. 5700 V. Rectangular; approx. size 6 1/4" x 4 1/4" x 3 3/4" with stand-off 7/16"—13 Mills D.C. GE K52J652-62. T3F-7. .... **\$3.95**

Power-Fil. Trans.; "GE" #7467899; Pri. 115 V.—60 cyc.; Sec.; 1.113 tapped at 1.0 V. .3V. & 7.5 V. @ .06 amps; 7 lug terms.; on ceramic bushings; plated steel case; size 1 7/8" x 2 1/4" x 2 3/4" H. T2E-17 ..... **\$1.10**

Plate-Trans.; Pri. 115 V.—400 cyc.; Tapped Pri. Sec. 780/875/900 V.; (Variable w/pri.volt.); @ 410 Ma. C.T.; metal case; mtg. holes; lug terms.; wt. 4 lbs.; 4 ozs.; size 3 1/4" W. x 3" D. x 3 1/4" H. "WE" WSP-1035. T3F-3. .... **\$0.99**

Plate & Fil. Trans.; Pri. 115-400 cyc.; 2 Sec.; #1-0-560-100 V.—50 Ma.; #2-2.5 V.—5 amps. NCT.; w/electrostatic shield; open frame mtg.; lug terms.; wt. 2 lbs.; size 3 1/4" W. x 2 1/4" D. x 3 3/4" H.; "Acme"; #KS-9336. T4G-2. .... **\$1.10**

Power-Fil. Trans. Step-down; "GE" type #68Q779; Pri. 55 V.—60 cyc.; Tapped @ 40, 20, 4 & 2 V.—60 cyc., Sec. #1, 22 V. @ 15 Ma.—C.T.; Sec. #2, 22 V. @ 15 Ma. C.T.; rectangular metal case; approx. size 3 3/8" x 2 3/8" x 3 3/8" porcelain standoffs. T2A-1. .... **\$1.49**

AF video trans.; input; 3 windings; 0.5 ohms ca. imp.; metal case; potted; 1 1/4" x 2 1/4" x 2 1/4"; "WE" #KS-9623; (max. audio oper. level 1/10 W.); turns ratio pri. to sec. 1 to 1; freq. 10 KC. to 1 mcg.; 6 lugs; stud mtg. P/O indicator 1D-56/APQ-7. .... **\$1.10**

Fil.-Trans.; "GE" #7467890-1; 41.2 V.—6 amps.; 380 to 2400 cyc.; rectangular; with 4 mtg. screws; 5 lug terms.; porcelain standoffs; size 3 3/8" x 2 3/8" x 4 3/8" H. T4E-1. .... **\$0.69**

Audio osc. trans.; 400 cyc.; pri. to 1st Sec. 1.0-4; #2 Sec. 1.0-1; size 1 1/2" dia. x 1 3/4" L.; 4 lug terms.; 3 screw lugs; #ES-692927. .... **\$0.39**

### RADIO TRANSMITTER AND RECEIVER APS-13

Light weight air-borne radar system, radio transmitter and receiver APS-13; tube complement 5-6J6; 9-6AG5; 1-VK105; 2-D21; unit is brand new, complete with tubes; the tubes alone are worth more than this low price of only. .... **\$12.50**

Working instructions for Wireless Set #19 Mark II ..... **\$0.29**

All Prices F.O.B. New York City, N. Y.

### HIGHBRIDGE RADIO-TELEVISION & APPLIANCE CO.

343 CANAL NEW YORK 13, NEW YORK

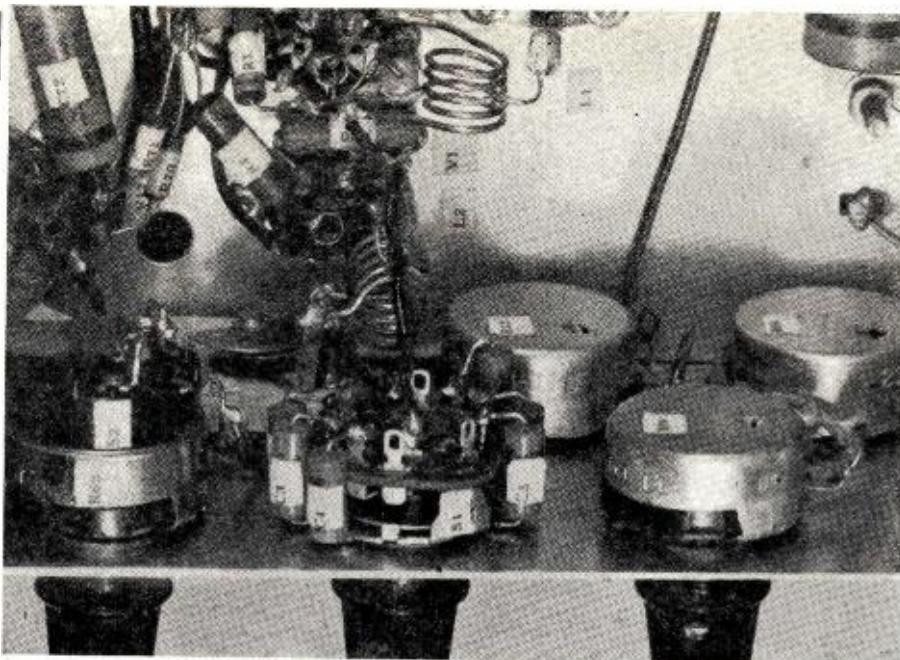

Enlarged view shows position of coils L<sub>1</sub> and L<sub>2</sub>

speaker. This adjustment should be repeated several times, each time with a lower input signal.

After sharp and sensitive tuning has thus been accomplished, connect the voltmeter across the two discriminator output resistors ( $R_{31}$ ,  $R_{32}$ ) and with an unmodulated signal strong enough to show a fair meter deflection, readjust the discriminator coil core ( $T_3$ , lower screw) to a point where the meter swings suddenly through zero and indicates reverse polarity. When this point is found, carefully conclude the adjustment by setting the core screw to make the meter indicate zero between positive and negative swings.

After completing all i.f. adjustments, seal the core screws in place with a little plastic cement.

The receiver can then be tried for television reception. Attach the antenna and set the bandswitch to the channel of a station known to be on the air at the time. With "Contrast" and "Sound Volume" controls at maximum clockwise position, adjust the oscillator fine tuning for reception. As the sound tuning is rather sharp, slow careful adjustment should be employed to find the best point for suitable tone quality.

If no signal is received the r.f. oscillator's (V.) d.c. grid voltage should be tested to be sure that the usual negative-to-ground voltage is present. This may average between -7 to -20 volts and its absence is a sure sign that the oscillator is not operating. The cause must be corrected before superheterodyning can be expected.

It should be remembered that the incoming signal may be received on the wrong channel-switch position, until the oscillator coil itself is adjusted.

The use of a signal generator covering the u.h.f. range or the second and third harmonics of a test oscil-

lator whose maximum fundamental signal is 30 mc. will be of considerable help in determining the coil adjustments required.

If channel three signals come in on channel two position of the selector switch, for instance, this indicates that the oscillator is operating at too high a frequency and that its inductance must be increased. With the set turned off, the inductance of the oscillator coil can be increased by compressing its spring-like windings between the thumb and forefinger. Close examination should follow to determine that none of the individual turns are touching each other or any nearby points.

After the tuning is properly adjusted and the set connected to its own antenna, the antenna coil  $L_1$  can also be compressed or expanded to improve reception. Connecting the voltmeter to the detector output as for picture i.f. alignment, the incoming signal should be tuned to maximum with the tuning control. The antenna coil can then also be adjusted for maximum signal indication on the meter.

### Servicing Methods

One of the prime considerations in the design of this miniature television receiver was simplicity. This, together with the use of modern miniature tubes and a stagger tuned picture i.f. channel, makes servicing relatively easy.

Standard signal tracing procedure can be employed throughout the receiver or as an alternative, *signal injection* is equally effective.

To test the two audio stages an a.f. signal, for example a 400 cycle tone, can be injected into the reverse succession of grids and plates, working backwards from the speaker to the discriminator.

The video amplifier can be checked with the same a.f. signal working back

from the cathode-ray tube grid to the picture detector. *Because of high voltage, a careful analysis of all points in the cathode-ray tube circuit should be made and tests conducted with due regard to safety requirements.*

When an audio signal is applied to the video input, horizontal lines will appear on the CR tube screen provided, of course, that the sweep circuits are functioning.

Failure of a sweep deflection can be traced forward between the blocking tube oscillator and the deflection plates. If no signal is obtained from an oscillator a confirming check can be made by testing for the presence of a negative voltage at its grid. If none is present, the oscillator is definitely defective.

To test either the picture i.f. or the sound i.f. amplifiers, signals of the proper frequency can be injected in reverse order between the detector (or discriminator) and the mixer tube. Any failure in the path of the signal should be investigated by testing the supporting "B plus" and bias voltages and possibly rechecking the alignment.

Since information has already been given on the antenna and oscillator circuits, their servicing can be considered in the light of standard superheterodyne practice.

As a final note, it will probably be found well worthwhile for the constructor to spend as much time familiarizing himself with the above tests as he spends on actual wiring, for that is an ideal way to achieve a basic training in the fundamental performance of his television receiver. Knowing one receiver well will certainly help in the mastery of others.

-50-

Max Joseph Bonsted, W2EQ of Audubon, New Jersey, recently relayed the instructions of Dr. Ralph W. Davis (left), Chief Surgeon at Audubon Hospital, over 6000 miles of ether to tiny Palmyra Island in the Pacific where an unidentified soldier was dying of injuries received in a plane crash. Following the doctor's instructions, men treating the soldier reported that he seemed to be improving. With no physicians available on Palmyra Island, a government weather observer used his ham station to contact Bonsted, who called in Dr. Davis to complete this transoceanic medical consultation.



### CATHODE RAY TUBE SCOOP

All New—Factory Cartoned

3BP1....Net	\$2.95
5CP1....Net	3.95
5BP1....Net	3.95
5FP7....Net	3.95
7BP7....Net	4.95
9LP7....Net	4.95

75% OF ALL THE TUBES YOU USE AT 49¢ EACH GUARANTEED STANDARD BRANDS CARTONED AND UNCARTONED

49¢

12A6	6V6GT	6SD7	185	6C5	0Y4
12H6	6SN7GT	12SL7	1T4	6F6	12SJ7
12SH7	39	6FB	384	6BA7	12SR7
1631	76	26	1L4	6SK7	6C6
1632	37	27	3A4	6SQ7	6D6
12SA7	5Y3	6H6	1R5	6K7	77
12SK7	5Y4	6SH7	12AT6	41	78
12SQ7	1633	38	12BA6	42	6SC7
35Z5	1644	6J5	12BE6	38	6SL7
50L6	12SN7	9003	35W4	12J5	
			50B5	6K6GT	

69¢

7E5	1N5	6V6	14B6	0Z4	1LN5
7N7	1A5	6K7G	50A5	117Z6	1LC6
7A8	7A7	7Y4	35Y4	7E7	6I6
7B8	7A4	7Z4	35Z3	7Q7	1LA6
6A8GT	7B4	7C5	35A5	787	1LB4
3Q7	7B6	14A7	14B8	787	1LB4
1A7	7C6	14Q7	14R7		1LD5

### SUPERHET BROAD-CAST TUNER

For connection to phono amp. or P. A. system. Compact chassis 5x3 1/4 x 3 inches. May be mounted inside the record player cabinet. Requires only three connections to amplifier. Uses 6BA7 or 12SA7; 6SK7 or 12SK7 and crystal diode. Complete with tubes, loop antenna, dial and instructions for connecting to any amplifier. Net \$7.95. Specify if tuner is to be used with AC or AC-DC type amplifier.

### 80 WATT SOLDERING IRON \$1.79

Genuine Solder Master. Has 3/8 set screw tin Russend construction. Scoop price... \$1.79  
100 Watt Solder Master. Extra heavy duty Scoop price... 2.49  
115 Watt ICA soldering iron. This is the best serviceman's iron we have ever sold. There is no better made. Scoop price... 3.98

### 10 STATION INTERCOM \$29.95

This 10 station push-button inter-com. originally cost the dealer over \$40.00. Attractive walnut finished cabinet; made by East coast manufacturer. With tubes 14F7, 50L6 and 35Z5. Master and one sub-station, net \$29.95. Extra sub \$5.95 each.

### RU-19 REC. \$7.95

#### 2-BAND AIRCRAFT RECEIVER RU-19

Priced complete with six tubes, 3 78's and 2 77's plus twin output tube. Guaranteed to be in good condition.

RU-19 type A receives 200 to 400 KC and 4130 to 7700 KC....\$7.95  
RU-19 type B receives 200 to 400 KC and 2500 to 4700 KC....\$7.95

### RU-19X FOR SALVAGE \$2.95

RU-19X or ARMY equal. SALVAGE PARTS SCOOP. Has many usable parts, condensers, resistors, etc. Less tubes and plug in coils. All are in good condition. RU-19X Salvage Scoop \$2.95 ea.; two for \$5.00.

### BC-310B RECEIVER \$24.95

Bendix Radio Compass Receivers. Built in dynamotor. 14 volts DC input. 5 gang tuning condenser, 3 bands; 150 KC through broadcast band to 1500KC. Has S meter, 12 tubes, (6 volt type). A beautiful radio receiver. Easy to convert to AC operation. In good condition. Weight 30 lbs. Net \$24.95

**McGEE RADIO CO.**  
1225 McGee St.

### G.I. RECORDER MECHANISMS

Latest 1947 General Industries recording assemblies with 4 ohm magnetic cutters and crystal play back.  
Model R70-L-78 RPM, Net.....\$24.50  
Model R90-L-33 and 78 RPM, Net.....\$28.95  
Model R130-L-automatic changer with cutter, 78 RPM, Net.....40.10

### 3-TUBE RECORD PLAYER \$9.95

POWERFUL SINGLE RECORD PLAYER KIT Z-26. Housed in an attractive leatherette covered cabinet. Latest 78 RPM rim drive motor and light weight pick-up. Ready wired and tested 50L6 type three tube amplifier. Tone and volume control. 5" PM speaker (Alnico V). This kit easily slips together. Priced complete with tubes and hook-up instructions. Kit Z-26....Net \$9.95

### 2-POST RECORD CHANGER \$11.95

Latest Maguire 2 post record changer. Plays 10 12" or 12 10" records. Scoop Price .....\$11.95  
Aero Changer—Single post; plays 10 12" or 12 10" records. While they last .....\$13.95  
Detroit Changer—Single post plays 10 12" or 12 10" records....\$14.95  
Individually designed walnut, made to fit, base \$2.49 extra; for Maguire Aero or Detroit Changer.

### SCOOP PRICES ON PM SPEAKERS

3 1/2" PM 1.5 oz. Alnico V.....	\$1.29
4" PM 1 oz. Alnico V.....	1.29
5" PM 1 oz. Alnico V.....	1.29
5" PM 2 oz. Alnico V.....	1.49
6" square 2 oz. Alnico V.....	1.79
6" G.E. and output Alnico V.....	1.95
6" Rola P.P. output Alnico V.....	1.95
12" PM 5 oz. Alnico V.....	5.95
12" PM 7 oz. Alnico V.....	6.95

### PHONO MOTOR SCOOP \$1.95

Yes that is the right price only \$1.95. Latest type rim drive 110 volt 60 cycle AC phono motor. Best type of construction. Only 2000 to sell while they last only .....Each \$1.95  
Latest type light weight crystal pick up arm, standard output crystal. Scoop price.....\$1.69

### AMERICAN XTAL CARTRIDGE \$1.49

American crystal replacement phono cartridge. Standard mounting; most one size used. Long shielded leads. Scoop price.....\$1.49

### SCOOP PRICES ON VIBRATORS

Standard 6 volt vibrators for every day replacement use—All guaranteed. Genuine Mallory sync vibrator unit. Ideal to put in old car for Buick, Delco, etc. Scoop price .....\$0.95

4 prong w/ surplus; new in bent cases.....	0.75
4 prong UTAH NP-42 for Philco.....	1.29
4 prong SMALL for Ford.....	1.49
4 prong OFF-Set for Delco.....	1.49
5 prong standard sync.....	1.49
6 prong standard sync.....	1.49
6 prong reversible sync.....	1.99
7 prong reversible sync.....	1.99
5 prong OFF-Set sync.....	1.99
Sync. unit; Vibrator unit only; with cond.....	1.99
7 prong 2 volt; G. E. sync.....	1.99

### 2-TUBE PHONO-OSCILLATOR

Complete wired and tested. 800 to 1500 KC. Model B-4. Has audio gain stage for proper power output. Complete with tubes ready to operate.....\$3.69

### MIKE-OSCILLATOR

800 to 1500 KC  
Mike Oscillator model C-4. Not only does the unit work as a phono-osc. but has added gain stage for a crystal mike. Priced complete, wired and tested with 3 tubes and fader control. Net \$4.95. Crystal Mike.....\$4.90 extra

### DELUXE MIKE OSCILLATOR

800 to 1500 KC Phono-Mike Oscillator. Makes any receiver a P.A. system. Record player or Recording amplifier. 3 stage high output unit with power transformer for AC operation only. High gain input stage for crystal or dynamic mike. Control on panel for fading recording to voice, simulating an actual broadcast station. Model DL-5 Complete with 3 tubes, wired and tested. Net \$7.95. Crystal Mike.....\$4.90 extra

Send 20% Deposit  
Balance Sent C.O.D.  
**KANSAS CITY, MO.**

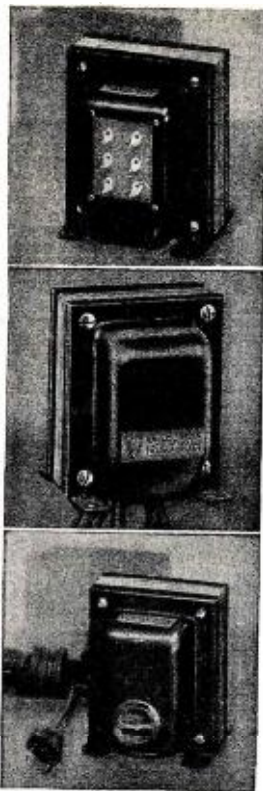

For Those Who Demand the Finest

## Typical Examples of the HALLDORSON Quality Line!

Preferred by those who demand and know the finest . . . each and every HALLDORSON TRANSFORMER is checked and rechecked before leaving the factory . . . our supply is still limited, but we anticipate having our line available in ample amounts in the near future . . . meanwhile permit us to serve you as best we can with our complete line of transformers.

**AVOID DELAY . . . ORDER TODAY**

*Jobbers: Get on our mailing list today*

The HALLDORSON COMPANY  
Since 1913  
4500 N. Ravenswood • Chicago 40, Ill.



**HALLDORSON Vacuum Sealed TRANSFORMERS**

**BUILD BETTER ELECTRONIC EQUIPMENT**  
with STANDARDIZED



for  
**ALL  
P. A.  
NEEDS**

Par-Metal Equipment is preferred by Service Men, Amateurs, and Manufacturers because they're adaptable, easy-to-assemble, economical. Beautifully designed, ruggedly constructed by specialists. Famous for quality and economy.  
Write for Catalog.

**READY-  
TO-USE  
CABINETS  
•  
CHASSIS  
•  
PANELS  
•  
RACKS**

**PAR-METAL  
PRODUCTS CORPORATION**

32-62-49th ST., LONG ISLAND CITY 3, N. Y.  
Export Dept.: Rocke International Corp.  
13 East 40 Street, New York 16

### DEPENDABLE

#### D. C. Power Supplies

Whatever your need may be, we have as a standard model or can custom build to your order a dependable source of low voltage direct current. Whether you need a power source for laboratory use, production testing, industrial application, or for powering equipment designed originally for battery use, we can help you.

If your requirements are not filled by the models listed, a letter to our engineering department, giving voltage, current requirements and intended application, will be promptly answered.

Models listed below all plug into standard 115 volt-60 cycle A.C. lines; are housed in attractive metal cabinets, finished in wrinkle enamel; and are equipped with fuse, on-off switch, protective circuit breaker, and pilot light.

MODEL V-12-30 delivers 12 amperes of filtered direct current within the range of 2-28 volts. Voltage continuously variable by means of control knob. This unit is complete with voltmeter and ammeter. Fine for aircraft radio servicing, production testing, etc. . . . . Net \$84.50

MODEL I-12-12 delivers 12 volts at 12 Amperes filtered D.C. Ideal for operation of your 12 volt surplus equipment requiring 12 Amperes or less. . . . . Net \$32.50

MODEL I-24-10 delivers 24 v. at 10 Amp. filtered D. C. For 24-28 volt equipment requiring up to ten amperes. . . . . Net \$45.75

MODEL I-24-24 delivers 24-28 v. at 24 Amp. Filtered D.C. Unit is suitable for powering ART-13 or BC-375E transmitters and dynamos in I.C.A.S. operation. . . . . Net \$87.50

MODEL I-24-2 delivers 24 v. at 2 1/2 Amp. of filtered D.C. operating relays, and other low current applications. . . . . NET \$16.65  
Terms: Check or M.O. with order or 20% with order, balance C.O.D.—F.O.B. Brooklyn, N. Y.

**ELECTRONIC CONTROLS COMPANY**

Box 142 Vandervoer Station, Navarro 8-3278

BROOKLYN 10, N. Y.

### 2 Meter Receiver

(Continued from page 59)

They are somewhat overcoupled, a desirable feature where three stages are going to be used, and are double tuned by means of adjustable iron cores. The fixed capacity across each winding is 50  $\mu\text{fd}$ . which results in a fairly high "C." If it is not possible to obtain similar transformers, standard FM i.f.'s of either the 4.3 or 5 mc. type may be used.

In designing the front end of such a receiver the problems are more mechanical than they are electrical. The diagram reveals nothing unusual in this section except perhaps the method of coupling between the sections. (Coupling between the oscillator and mixer was found to be best when there was no intentional coupling and stray fields alone were used.) This takes care of the problem of interaction between the oscillator and mixer circuits and also reduces the amount of distributed capacity across both tuned circuits.

The mixer grid is capacity coupled to the plate of the 6AK5 by means of a choke coil which resonates just outside the band by means of its own distributed capacity plus that of the 6AK5. The coupling capacitor is very loosely coupled to the low end of the 9001 grid coil by tapping on only a short distance up from the bottom. This provides a good impedance match between the two circuits and prevents loading and broadening of the 9001 grid circuit. This grid circuit tunes critically and provides a surprisingly high order of gain and selectivity. By keeping the distributed capacity in the circuit at a very low point a fairly large amount of inductance can be built into the coils, thus increasing the gain.

The 6AK5 r.f. stage provides a gain of 3 to 4 and is unquestionably worth the trouble of including it in the receiver. The antenna is coupled into the grid of the 6AK5 by the same low impedance method. One side of the 300 ohm line is grounded to the ground point of the tuned circuit and the other side is connected a short distance away on the coil, between a quarter and a half turn up from the start. This method of coupling a balanced line does cause some unbalance and it would be preferable to couple by means of a two turn link around the lower end of  $L_1$ . The tuning of the 6AK5 grid circuit is not quite as critical as that of the 9001. It is a true preselector, however, and cannot be set in the middle of the band and work efficiently over the whole band. Tracking of this stage with the mixer and oscillator stages is accompanied by a noticeable increase in background noise. This fact shows that a high degree of "Q" has been obtained in the tuned circuits and offers a convenient method of finally adjusting the ganging of this stage.

The mechanical arrangement of the front end has a great deal to do with its final success. From the illustrations it may be seen that each stage, the oscillator, mixer, and r.f. amplifier is separately assembled on a sheet of polystyrene  $\frac{1}{8} \times 2 \times 2\frac{1}{2}$  inches. The tube socket, tuning condenser, coil, and all other resistors and condensers are assembled complete on these small panels before putting them together into the final assembly. Polystyrene rod,  $\frac{1}{8}$  inch diameter, is drilled and tapped on each end and 6-32 machine screw studs are inserted so that they may act as spacers between the sections and can be assembled by screwing the stud from one into the threaded end of another through holes in the panel assemblies. A small vertical shield, 3 x 4 inches, is provided between the mixer and r.f. stages. In the illustration, the r.f. stage is closest to the panel, the mixer is behind it, and the oscillator is at the rear of the chassis.

When the shaft couplings have been added the entire assembly is complete in itself and can be ganged and pre-tested before assembling into the receiver. Four spade bolts, two at the front and two at the rear, project downward from the front end assembly and permit it to be easily fastened in place on the chassis.

Probably the most troublesome part of building any superhet receiver, and the obstacle that keeps more hams from trying it, is the problem of getting it lined up properly, particularly in the absence of elaborate test equipment. A method will be described by which a receiver such as this one can be aligned with very little equipment. In fact, this was the method by which the receiver pictured was actually first put into operation. One of the few absolutely essential pieces of equipment is some sort of a signal generator for setting the i.f. transformers. This can be a very inexpensive service type oscillator or a homemade affair with some sort of tone modulation added. The accuracy need only be within ten per-cent on frequency and no output calibration is necessary. Begin by lining up the i.f.'s at whatever frequency they are to be operated. In the case of the receiver being described here, the frequency was 6 megacycles. Keep the input coupling between the generator and the first transformer just as loose as possible and still maintain an audible signal. This will prevent double peaking of the i.f. transformers and will also show up any tendency on the

Circuit that was used to preset coils and condensers to proper frequency.

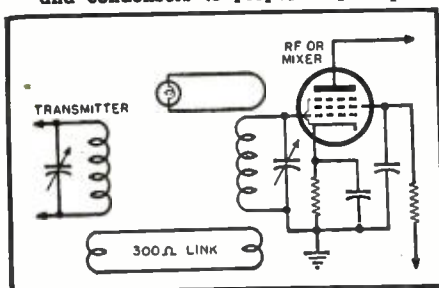

September, 1947



does these  
3 jobs  
better

THE CRESCENT  
*Speakers*

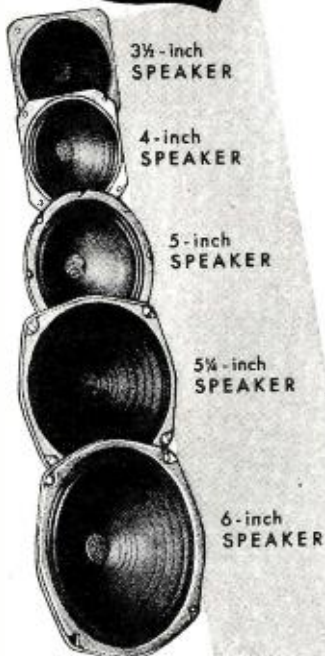

Crescent Speakers, designed and engineered to the most exacting standards, deliver the finest in tonal performance.

performs • endures • attracts

The most attractive and well designed changer in the popular priced field. Equipped with dependable cushion mounted motor — "Barry" mounts to eliminate vibrations and fool-proof in operation. Hammertone finished with smart plastic trim. Has both reject button and control knob for convenient on-off-manual and automatic operation. Plays 10" or 12" records automatically.

CONTACT YOUR CLOSEST  
CRESCENT SALES REPRESENTATIVE  
WM. RUTT, c/o CRESCENT ELECTRONICS CO.  
401 Broadway, New York 13, N. Y.  
MILLER-JOYCE CO.  
609 S. Vermont Ave., Los Angeles 5, Calif.  
LES LOGAN CO.  
530 Gough St., San Francisco, Calif.  
HARRISON-REYNOLDS CO.  
419 Commonwealth Ave., Boston 15, Mass.



**CRESCENT INDUSTRIES INC.**  
4132-54 W. BELMONT AVENUE  
CHICAGO 41, ILLINOIS

# NUMBERS 4 and 5 OF THE WALSCO Hit Parade

THE SENSATIONAL, NEW, SCIENTIFIC

## WALSCO STANDARD TEST RECORD

FOR IMMEDIATE . . . ACCURATE . . . AUDIBLE ADJUSTMENT OF RECORD CHANGERS AND COIN OPERATED PHONOGRAPHS . . . SOLVES THE PROBLEM OF ADJUSTING PICKUP AND TRIPPING MECHANISM THROUGH



- Three Tone lead-in grooves permits immediate adjustment to proper set down position of the pick-up through audible means.
- Made to RMA and NAB standards.
- Record plays in less than 40 seconds.
- Audio tone at end of record indicates proper adjustment of tripping action.

The WALSCO Standard Test Record saves time and increases efficiency in the adjustment of record changers and coin operated phonographs. Write for full information.

# WALSCO products

Help The Radio Man

WALTER L. SCHOTT CO. BEVERLY HILLS CALIF. CHICAGO 5, ILL.

## WALSCO UNIBELT THE UNIVERSAL DIAL DRIVE BELT CAN BE CUT TO FIT ANY DIAL DRIVE Will not Slip or Stretch

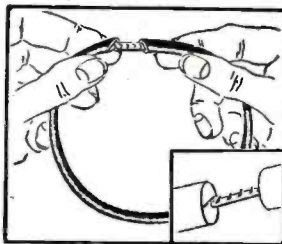

"UNIBELT" comes in 5-foot length spools and can be installed without taking dial mechanism apart. A real time and money saver. Eliminates the need for stocking numerous sizes of belts.

Free sample and literature. Write to Dept. 8A

## New! Munger ELECTRO-BEAM ROTATOR

Now You Can Have the Best Type of Directional Antenna at Low Cost!



PRICED  
AT ONLY

**\$69.50**  
COMPLETE

F.O.B. Chicago, Illinois

ORDER ONE  
NOW!

- Price Includes Reversible Electro-Beam Rotator and Direction Indicator.
- Foolproof Potentiometer and Meter Circuit. Calibrations in Both Degrees and Directions.

A SENSATIONAL VALUE

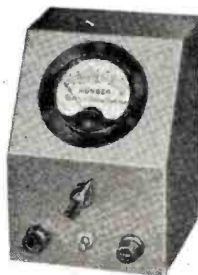

When you see the many fine features of my new Electro-Beam Rotator, you'll be as pleased as I am. And you'll feel good too, because it's such an honest value—priced low because we kept you in mind constantly through all the stages of design, engineering and testing. Now that it's ready for delivery, you can take my word that it's a real honey. About the specs: 1 R.P.M.—115 volts, 60 cycle operation. Powerful reversible motor drives main shaft through heavy steel gears. Lifetime Oilite bearings. Mechanism is completely weatherproofed—housed in sturdy non-rusting duraluminum case. All parts accessible for easy inspection. Rotator mechanism weighing only 10 1/2 lbs. makes it easy to mount. Top mounting plate 10" x 12"

10 Day Free Trial Offer—No Risk

Send your check for \$69.50 for one Electro-Beam Rotator complete with Direction Indicator. You pay small express charge upon arrival. Try it at my risk for 10 days. If you are not completely satisfied in every way, return the units undamaged in their original carton and your money will be immediately refunded in full. You take no chances. Order your Munger Electro-Beam Rotator today!

Illustrated Bulletin on Request  
MANUFACTURED AND SOLD  
EXCLUSIVELY BY



W9LIP

**Rex L. Munger Company**  
4701 Sheridan Road Chicago 40, Illinois

## ELECTRONIC VOLT-OHMMETER

\$11.85

POSTPAID

110 VOLTS AC 20 RANGES  
0/5/10/50/100/500/1000/5000 volts;  
DC and AC. 0—1,000,000,000 ohms  
in six overlapping ranges. Sensitivity;  
over MILLION OHMS per VOLT on 5  
volt range.

Complete kit includes all component parts, tubes, punched and drilled chassis and beautifully enameled panel. Easily assembled and wired.

Special slideback circuit developed during war by scientist at the California Institute of Technology gives amazing sensitivity and flexibility while completely eliminating necessity of batteries and expensive meter. Each instrument is individually calibrated. Dial scale over nine inches long!

In addition to performing the usual volt-ohm functions, this instrument easily measures these voltages: SUPERHET OSCILLATOR, AVC, APC, TRUE GRID BIAS AT THE GRID, BIAS CELLS without affecting the circuit. Measures the exact leakage resistance of INSULATION, TUBES, CONDENSERS. It can be used with a signal generator for SIGNAL TRACING.

**STERLING ELECTRONIC COMPANY**  
Dept. 3  
BOWLING GREEN, KENTUCKY

## EASY TO LEARN CODE

It is easy to learn or increase speed with an Instructograph Code Teacher. Affords the quickest and most practical method yet developed. For beginners or advanced students. Available tapes from beginner's alphabet to typical messages on all subjects. Speed range 5 to 40 WPM. ALWAYS ready—no QRM.

ENDORSED BY THOUSANDS!

The Instructograph Code Teacher literally takes the place of an operator-instructor and enables anyone to learn and master code without further assistance. Thousands of successful operators have "acquired the code" with the Instructograph system. Write today for convenient rental and purchase plans.



**INSTRUCTOGRAPH COMPANY**

4711 SHERIDAN ROAD, CHICAGO 40, ILLINOIS

part of the i.f.s to spill over or oscillate. When all of the transformers have been aligned there should be a noticeable background noise in the speaker when the gain control is wide open. This should be noticeable but not over loud. Too much rush noise may indicate that the i.f. strip is oscillating and additional shielding or bypassing may be required. It may be well to point out here that the .01  $\mu$ fd. condensers shown bypassing the ungrounded side of the filament at each of the 6AC7 sockets were found to be very necessary to prevent oscillation. If oscillation still persists after using the values shown, try adding a .001  $\mu$ fd. mica condenser in parallel with the .01  $\mu$ fd. condenser already there. Also, a 1  $\mu$ fd. condenser on the filament supply bus under the chassis may help. Keep all leads very short. Bring all grounds associated with one stage to one point and ground absolutely nothing else at that same point. Keep the placement of parts under the small chassis as symmetrical and neat as possible, making sure that each stage is wired exactly the same as the others. By taking these precautions seriously, any number of these i.f. strips can be built and they will all work alike. Three have been built so far and no trouble has been experienced with instability.

In the event that other transformers are used (other than those shown in the diagrams) it may be necessary to increase the bias on the 6AC7's or possibly to add some resistance loading across a few of the transformer windings to keep them from "taking off." If the i.f.s are stable, bringing the hand near the input lead should be sufficient to bring in signals with good volume depending on the i.f. frequency used. In the case of the receiver being discussed, airplane signals could be heard all over the house with only the three inch piece of wire sticking out of the input transformer. If signals can be heard without whistles or squeals this is further indication that the i.f. stages are stable and are ready to be connected to the mixer stage.

Before connecting the i.f. channel to the mixer plate, however, a great deal of time can be saved if it can be determined whether the mixer grid is tuning somewhere in the 144-148 megacycle band. If the builder has a transmitter already on this band or knows of someone who has, the problem of aligning these stages before putting them into the receiver is very simple. Disassemble the three front end sections from each other so that the mixer stage can be handled by itself. With all of the circuit components wired in, the tube in the socket, without the filament or high voltage leads connected, couple the tuned circuit of the mixer to the plate tank of the transmitter. Turn on the transmitter without an antenna and connect a piece of 300 ohm line from the transmitter pickup coil to a small one-turn coil which is coupled to one end of the mixer coil. At the other end of the mixer coil, couple a small one-turn coil



with a flashlight bulb in series with it. By adjusting the mixer coil until the bulb lights with the tuning condenser some where near the middle of the range, the presetting of this stage can be accomplished. The r.f. amplifier is preset in much the same manner. When both of these stages have been adjusted they are ready to be reassembled and should be handled with care to prevent moving or changing any of the circuit components.

The oscillator must next be set on the band and this can be done in several ways. Perhaps the easiest way is to use a superregen receiver which tunes to at least 142 megacycles and to set the oscillator stage so that the superregen receiver blocks at this point when the oscillator plates are about 1/2 to 3/4 of the way out. The oscillator in this case will be working below the incoming signal, something which will aid stability and give a little more bandspread. By setting the oscillator at 142 megacycles it should be at the correct setting to receive signals around 148 megacycles provided the i.f. frequency is 6 megacycles.

After these preliminary adjustments have been made, the entire front end should be assembled and wired into the set. With voltages applied, the antenna should first be coupled into the mixer stage by means of a single turn coil held close to the grid end of the mixer coil. The mixer tuning condenser should be set at about 1/2 rotation and held there while the oscillator tuning condenser is rotated in and out until a signal is heard. Then tune the mixer stage until the signal is loudest. Note the relative positions of the two tuning condensers. If they are at widely different settings, adjust one or both coils until the two condensers tune in a signal at approximately the same relative setting. When this has been done, the ganging of these two stages is completed and the antenna may be coupled into the r.f. stage in the manner shown in the diagram. The r.f. stage is adjusted to track with the other two stages in the manner just described. When completed, the couplings between the three condensers can be tightened and the receiver is finished.

The presetting of the inductances in the manner described above should place the tuned circuits near enough to the correct value so that signals can be heard almost immediately with a little tuning around. This will save hours or even weeks of searching for the band. It should be pointed out that very small changes in inductance or capacity will make correspondingly large changes in frequency and therefore the builder is cautioned to make changes slowly and only a little at a time. Once the band is located no changes should be made in the oscillator circuit until after the mixer and r.f. stages have been completely aligned and adjusted and no further improvements can be made in them. Then, if desired, the tap on the oscillator coil can be adjusted for optimum oscillator amplitude. This can be de-

## BA Bargain Scoops!

### 52 OHM COAX CABLE

BRAND NEW 60 Foot COILS  
COMPLETE WITH CONNECTORS..... **\$1.25**

It's genuine Amphenol RG-5/U—use it in place of RG-8/U. Has smaller diameter (.332), less capacity between center conductor and shield, less weight, easier to handle than RG-8/U. Rated at 1100 watts at 30 Mc. Supplied complete with standard Amphenol 83-15P-(PL 259) connectors attached at each end.

No. 4A496—60 ft. coil with connectors..... **\$1.25**  
Any number coils connect together with 83-1J connectors (below)



### Extra Connectors

For use with above  
Choice Each..... **35c**  
83-15P 83-1R 83-1AP 83-1J

**10 Hy. - 200 Ma. Thordarson Filter Choke**  
200 ohm D.C. resistance, 2000 V. RMS, Size 3 3/8" sq. x 4 3/4" high. Wt. 5 1/2 lbs. Has 12" leads at side.  
No. 13A266 Special Each... **\$1.88**

80, 75 and 40 Meter  
**CRYSTALS, 10 for \$3.95**

In FT 243 holders, cut from highest quality quartz, accurately ground and acid etched. Frequency marked on each within 2 KC. Sorry we must sell them in ass'ts. our pick of frequencies—but you can't go wrong! There are plenty of choice frequencies for 80, 75 and 40 meters or for doubling to 20 and 10 meters in each ass't. Every one guaranteed to be an active oscillator.  
Stock No. 21T3991  
Asst. of 10 only..... **\$3.95**

### OIL FILLED CONDENSERS

10 mfd. 1000 volts C D  
Dykana TJU List \$12.00  
No. 17A268  
Spec. Ea..... **\$1.95**

8 mfd. 1000 volts Sprague  
List \$10.80  
No. 18A367  
Spec. Ea..... **\$1.45**

5 mfd. 600 volts Sprague List \$7.00  
No. 18A366  
Special Each..... **65c**

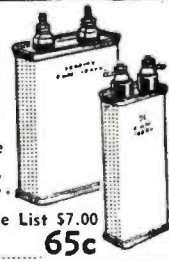

### JOHNSON VARIABLE



Dual section, 200 mmfd. per section, 2000 V. breakdown. Spacing .045".  
Type 200FD20.

List \$10.  
No. 18A510 Special Ea..... **\$2.95**

Johnson variable, dual section, 304 mmfd per section. Spacing .045".  
Type 300ED20. List \$9.95.  
Stk. No. 18A509, Special Each **\$3.45**

Our terms: Cash with order or COD with 20% deposit please. Add Postage

### HANDSET TS13

Combines a 200 ohm carbon mike and 2500 ohm ear phone with butterfly switch for "listen" and "talk". Has 6 ft. flexible rubber cord with 1 each PL55 and PL68 plugs attached. Attractive bakelite case, light weight.

Ideal for interphone outfits for home or industry, mobile and many other applications. Made to rigid Signal Corps spec.

A Truly Outstanding Surplus Bargain. Every One BRAND NEW.

No. 17A407, Special Each..... **\$3.95**



**\$250 Value** For **99c**

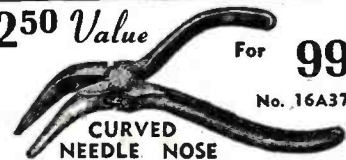

**CURVED NEEDLE NOSE**  
6" Crescent Tool Co. Drop forged "Crestaloy" steel, cadmium plated. Very handy for close quarters. At this price, every tool kit and bench should have one.

### Compact Rechargeable STORAGE BATTERY



Willard 2 Volt in Spill-Proof Clear Plastic case. Only 2 3/8" square and 6" high—(about the size of the ordinary #6 dry cell) make it applicable for a wide range of uses where battery power is needed. Rated at 24 AH. Gangs nicely for other voltages in multiples of 2 volts. Shipped dry. Uses standard battery electrolyte available everywhere. Every One Brand New. While They Last, **\$1.95**

No. 5A133. Special Each.....

### The "Tops" in Headphones

At a Fraction of Original Cost

8000-ohm impedance, highly sensitive. Best quality Alnico magnets in molded black bakelite cases, concealed terminals. Headband fully adjustable, leather covered spring steel. 12" cord with PL34 plug attached at side out of way. Jack and rubber cord supplied to extend length to 5 1/2 ft.



Extremely lightweight, only 9 oz., with removable rubber ear cushions of comfortable design. Made to Air and Signal Corps specs. Brand New—a 13.50 Value.

Stk. No. 17A37, Special Per Pair **\$2.49**

**BURSTEIN-APPLEBEE** Company  
1012-14 MCGEE STREET.  
KANSAS CITY 6, MISSOURI



Did You Get It?  
The New B-A Catalog No. 471

### AN/ART-B COLLINS



#### AUTO TUNE TRANSMITTER

A modern, compact, lightweight, high-powered transmitter. For frequency range 2-18 Mc. on any of its 11 auto tune crystal controlled or master oscillator channels. These units removed from planes. Checked and guaranteed. Weight, 67 lbs.

**\$100<sup>00</sup>**

COMPLETE WITH DYNAMOTOR UNIT

#### NAVY-CRV-46151

#### AIRCRAFT RADIO RECEIVER

INCLUDING CASE

**\$2975**



Four bands, including broadcast (195-9,050 KC). Circuit is six-tube superheterodyne with mechanical band change or remote operated electrical band change. Remote band change and tuning controls included, making this set readily adaptable to mobile ham use. Powered from self-contained 24 V. DC dynamotor.

The sets are complete with tubes, mounting rack and remote controls.

#### ARC-4 TRANSMITTER AND RECEIVER



INCLUDING CASE

**\$3975**

Operates on any of its 4 predetermined crystal controlled frequencies in the range of 140 MC. Complete with tubes, remote control, junction box, shock mounting base and connecting plugs. This unit is ideal for amateur UHF or mobile telephone. Operates from self-contained 24 V DC dynamotor. 12 V available upon request.



#### RADIO ALTIMETER APN/1

A complete 460 mc. radio receiver and transmitter which can be converted for ham or commercial use. Tubes used and included: 4-12SH7, 3-12SJ7, 2-6HG, 1-VR150, 2-955, 2-9004. Other components such as relays, 24 V dynamotor, transformers, pots, condensers, etc., make this a buy on which you can not go wrong. Complete as shown in aluminum case 18"x7"x7 1/4"

**\$1495**

TERMS: CASH WITH ORDER

**AMERICAN SURPLUS PRODUCTS CO.**

537 N. CAPITOL AVE.  
INDIANAPOLIS, IND.

terminated by the signal-to-noise ratio as well as the general loudness of the signals received. Changing the tap will shift the oscillator frequency and therefore large changes should not be made at one time.

If a direct reading dial is to be made it is well to keep in mind that some drift can be expected up to 15 minutes after turning on the receiver so it is a good idea to allow it to become good and warm before attempting to calibrate the dial. If this precaution is taken, a perfect calibration can be obtained and it will remain accurate as long as no changes are made in the receiver. Antenna changes have no effect upon it, naturally.

-50-

### Vibrator Tester

(Continued from page 48)

There is nothing complicated about the vibrator tester. Nevertheless, it is a useful service instrument. One thing that is desired in a test is to try the vibrator for its ability to start at voltages likely to be encountered in actual service.

In order to accommodate the large variety of vibrators having different prong arrangements the tester would need at least seven sockets. However, the number of sockets to be included is a matter of personal choice. The diagram shows only two sockets. Additional ones may be used to take other vibrators if desired. Due to the fact that most of the sockets needed are special and hard to obtain, it is much easier to use just the two sockets shown. These two sockets will test a high percentage of all vibrators encountered. To take care of the remainder, two cables, with two wires each, and a single wire are brought out. Alligator clips with rubber insulators are put on the ends of each cable wire. One of the cables should be designated as the primary and the other as the secondary. The single wire is the common negative. Black rubber insulators may be used on the primary cable and red on the secondary. The common clip is left bare.

Inside the tester the cable marked "Primary" is connected to the top two contacts of the four-prong socket and the cable marked "Secondary" is connected to the top two contacts of the five-prong socket. The single wire is connected to the common negative lead, the one that connects to both sockets, the meter, the potentiometer, the battery, load resistor, and the filter condenser. Fig. 2 shows how the five wires are to be connected.

To test a vibrator using these wires it is only necessary to refer to the vibrator connection circuits in a service encyclopedia. It is easy to connect the wires to the prongs. For a non-synchronous vibrator only the primary cable and the common wire are needed. The common wire is connected to the reed prong and the cable wires are connected to the contact

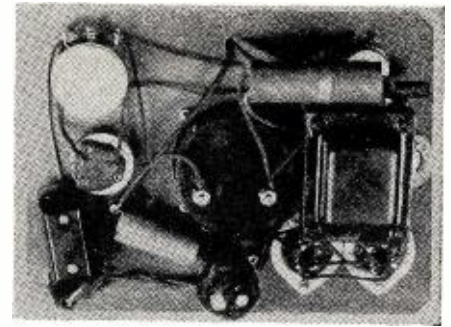

Internal view of vibrator tester. All parts are mounted direct to front panel.

prongs. The switch on the tester should be in the position so that the output from the secondary of the transformer passes through the rectifier tube. For testing a synchronous vibrator the common wire is connected to the reed prong, the primary cable wires are connected to the primary contact prongs, and the secondary cable wires are connected to the secondary contact prongs. The synchronous interrupter switch should be thrown to the position for synchronous vibrators. The polarity reversing switch should also be thrown to the correct position.

To test any vibrator, first place it in the proper socket or turn it upside down and connect it into the circuit with the cables as explained above. The voltmeter switch is then thrown to the input position. The synchronous interrupter switch is thrown to the proper position, depending on whether the vibrator is synchronous or non-synchronous. The polarity reversing switch is used only when testing synchronous vibrators. It is then switched to the position that gives a positive voltage on the side of the load resistor that connects to the cathode of the rectifier tube. The position of this switch depends upon the arrangement of the secondary contacts in the vibrator. It is important that the correct polarity be obtained before the tester is allowed to remain on because reversed polarity will damage the electrolytic filter condenser if allowed on any length of time. The push switch that connects

Fig. 2. Wiring diagram shows method used to connect, externally, vibrators with base connections other than those provided on the original testing panel.

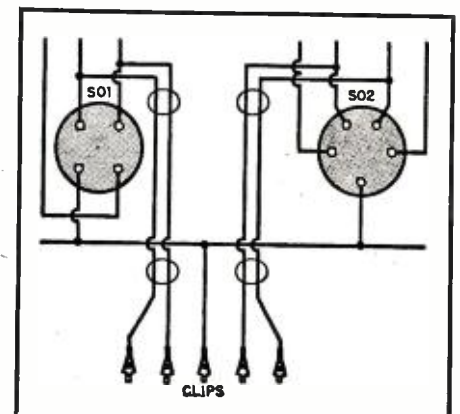

RADIO NEWS

# UNBELIEVABLE VALUE!!

## a Multi-Range VOLT-OHM MILLIAMMETER **AND** ALL-WAVE SIGNAL GENERATOR



**BOTH FOR ONLY \$34.85**

Don't pass up this amazing introductory offer! Rush your order now for this sensationally low-priced combination. Skeptical? . . . of course . . . but rush your order anyhow we guarantee to refund your money in full if the units do not meet with your complete approval after a 10 day FREE trial.

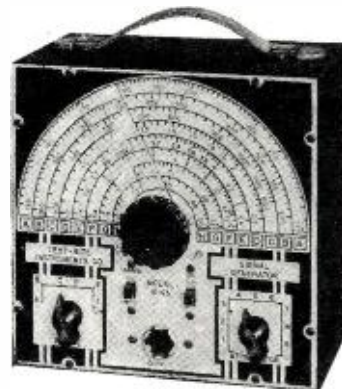

### Specifications of Model M-50

- Accurate Pocket size V.O.M. using full size D'Arsonval meter
- 4 A.C. VOLTAGE RANGES: 0-15/75/300/1500 volts.
- 4 D.C. VOLTAGE RANGES: 0-15/75/300/1500 volts.
- 2 D.C. CURRENT RANGES: 0-15/150 MA.
- 2 RESISTANCE RANGES: 0-10,000 ohms; 0-1 Megohm.
- Attractive modern black and white panel.
- Beautiful hand-rubbed oak case. Complete with test leads and all operating instructions.

### Specifications of Model B-50

Generates RF frequencies from 150 Kc. to 50 Mc. Modulation is accomplished by grid-blocking action—equally effective for alignment of amplitude and frequency modulation as well as for television receivers. Self-contained batteries. All calibrations etched on front panel for DIRECT READING. Beautiful processed dualtone front panel in heavy gauge crystalline steel cabinet. Complete with test leads and batteries.

20% deposit required on all C.O.D. orders.

**MOSS ELECTRONIC DISTRIBUTING CO.** 68 WESTCHESTER SQUARE  
Dept. RN-9, NEW YORK 61, N. Y.

... and now  
**Television!**

Bright  
Steady  
Clear  
No Eye  
Strain

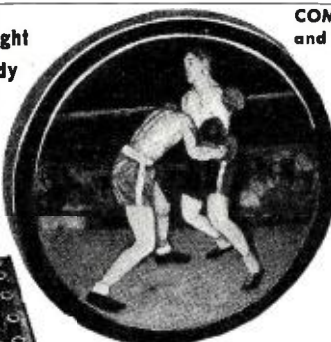

The First 10" Flat Surface Picture Tube  
**FRONT END**

Will handle 13 television channels. It is so flexible that any number of channels from 1 to 13 can be used. This allows a start with the channels now in use 2-4-5-7-9-11-13 and then install the others as desired for a slight additional cost

#### TUBES

- 6AK6—Tuned R.F. Amplifier
- 6AK5—Mixer
- 6C4—Oscillator

#### ANTENNA INPUT

Balanced 300 ohm line.

Aligned and tested, ready to use when delivered. Merely connect B plus, filament and output I.F. leads to the television chassis. It is not necessary to make any R.F. alignments

#### 5. TUBES:

- Five 6J6 — Picture I.F. Amplifier
- One 6J6 — Picture I.F. Amplifier & Detector
- One 6AU6 — 1st Video Amplifier
- One 6K6GT — 2nd Video Amplifier

#### 6. I.F. FREQUENCY — AUDIO 21.6 — PICTURE 26.1

All of the above circuits are contained on one chassis, delivered completely wired, tested, tuned and tubed ready for installation.

Also 1—12" RCA 8.6 oz. PM Speaker, 1 Specially Designed Dipole Antenna with 60 ft. Lead-in and Complete Pictorial Data, Schematic.

**TELEVISION ASSEMBLY CO., 387 Bushwick Ave. Brooklyn 6, N. Y.**

COMPLETE WITH ALL COMPONENTS  
and 29 RCA Tubes Plus 10" Flat Surface CR Tube

**\$22950**

Also Available with 12" Flat Surface CR Tube for

**\$25950**

10% Deposit with Order  
All Prices F.O.B. B'klyn, N.Y.

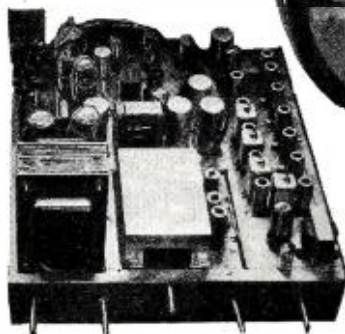

#### I. F. VIDEO & SOUND STRIP (PATENTS PENDING)

1. PICTURE I.F. STAGES:  
Five I.F. Picture Stages of Amplification.
2. SOUND I.F. STAGES:  
Two I.F. Stages with Limiter & Discriminator.
3. VIDEO STAGES:  
Two Video Stages of Amplification with a flat response at 4.5 M.C.
4. ONE D.C. RESTORER.

- One 6AL5 — D.C. Restorer
- One 6AU6 — Limiter
- Two 6BA6 — Sound Amplifier
- One 6AL5 — Discriminator

SIZE OF  
CHASSIS  
19"x17"x3"

**AUDIO**  
Two Stages of Audio Amplification are used.

#### TUBES

- One 6AT6—1st Audio Amplifier
- One 6V6GT—2nd Audio Output Amplifier

#### POWER SUPPLIES

Low voltage power supply is a well filtered supply using full wave rectification. Delivers 300V positive and 100V negative at 250 M.A. with good regulation at continuous duty. High Voltage Supply is of the Fly-Back type delivering approximately 10K.V.

Power consumption approx. 300 watts. Both Supplies use the following tubes:

- Two 5U4G — rectifiers as full wave rectification.
- One 8016 — H.V. rectifier half wave rectification.

#### SYNCHRONIZATION SEPARATOR SYNCHRONIZATION AMPLIFIER SWEEP CIRCUITS

#### TUBE COMPLEMENT:

- One 6J5 — Vertical Blocking Oscillator
- One 6SN7GT — Horizontal Blocking Oscillator
- One 6K6GT — Vertical Output Amplifier
- One 6B6GT — Horizontal Output Amplifier
- One 5V4G — Dumper
- One 6SK7GT — 1st Sync Amplifier
- One 6SH7 — Sync Separator
- One 6SN7GT — 2nd Sync Amplifier
- One 10" — Flat-faced Cathode Ray Tube

Guaranteed to operate to your satisfaction when simple directions are followed.

# THE MASTERS CHOICE!

SUPREME MODEL 504B  
TUBE AND SET TESTER

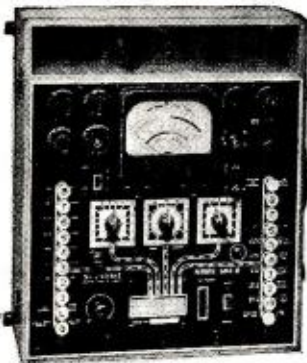

Any craftsman distinguishes himself by the appearance of his tools and equipment. For 19 years SUPREME equipment has identified thousands of successful radio service engineers. SUPREME equipped repair shops distinguish themselves for their professional appearance, dependability, and profitable operation.

One among the complete group of SUPREME radio testers is the Model 504B Tube and Set Tester.

- **METER**— large 4-inch square-face meter, 500 microampere.
- **SPEED**— push-button operated.
- **FLEXIBLE**— simple, yet Universal Floating Filaments feature insures against obsolescence.
- **SIMPLICITY**— roll chart carries full data for tube setting. No roaming test leads when using multi-meter—only push a button.

#### SPECIFICATIONS

DC VOLTS — 1000 Ohms per volt: 0.5-25-100-250-500-1000-2500.  
AC VOLTS — 0.5-10-50-250-1000.  
OUTPUT VOLTS. 0.5-10-50-250-1000.  
OHMMETER. 0-200-2000-20,000 Ohms  
0-2-20 Megohms

#### Condenser Check:

Electrolytics checked on English reading Scale at rated voltages of 25-50-100-200-250-300-450 volts.

#### Battery Test:

Check dry portable "A" and "B" batteries under load.

## SUPREME

SUPREME INSTRUMENTS CORP.

GREENWOOD, MISS.

U. S. A.



"SUPREME BY  
COMPARISON"

See the complete SUPREME line.  
Write for new SUPREME catalogue  
No. 447.

the battery into the tester circuit is closed and the potentiometer is adjusted until the voltmeter reads 5.2 volts. The switch marked  $S_2$  in Fig. 1 is closed. If the vibrator starts it is *good* and will likely give a great deal more service. However, if the vibrator fails to start at this point switch  $S_1$  should be opened and the potentiometer adjusted until the voltage is close to 5.6 volts. Vibrators that start between 5.2 and 5.6 volts are *doubtful*. They may be expected to give trouble very soon. Vibrators that start only on voltages above 5.6 are *bad*.

If the vibrator successfully passes the starting test it should be tried for output voltage. The potentiometer is adjusted until the input voltage is anywhere between 6 and 6.5 volts. The voltmeter switch is then changed to the output position. If the voltage is normal and remains fairly constant the vibrator is *good*. But, if the vibrator produces a badly fluctuating voltage or a voltage below nine-tenths of the normal voltage it is definitely *bad*.

#### Making the Scale

Operating the vibrator tester and interpreting its indications may be simplified by calibrating the meter so that it reads like a tube tester. The regular card should be removed from the meter and a new one prepared. The new one may be made by drawing on thin white Bristol board with India ink or it may be made from white paper and pasted on the regular dial card. The new card may be laid off from the original, using it as a template or pattern. Two scales should be calibrated—input and output. The meter being a 0-1 milliammeter is marked from 0 to 1 by tenths. When used in series with the 10,000 ohm resistor for the input circuit it becomes a 0-10 voltmeter. Therefore, to calibrate the input scale, the portion from 0 to .52 is labeled "*GOOD*," the portion between .52 and .56 is labeled "*F*," and from .56 to full scale is marked "*BAD*."

To calibrate the output scale of the meter, the necessary data should be obtained before removing the original card from the meter. The potentiometer is adjusted until the input voltage on the vibrator is between 6 and 6.5 volts, the meter is switched to the output circuit to see if the rectified output is normal, smooth, and fairly steady. The readings "*GOOD*" and "*BAD*" may be established by testing known good and bad vibrators.

The meter when switched to the output circuit becomes a 0-500 voltmeter due to the 500,000 ohm series resistor. The average output of a good vibrator should be about 240 volts. This may vary considerably, however, due to the components used in making the tester. For instance, the vibrator transformer has a great deal to do with the secondary voltage.

#### The Circuit

The complete wiring diagram of



## Ever wish you were Aladdin?

You remember him . . .

He was the lucky fellow who found a magic lamp. It gave him everything he wished for—from diamond-crusted palaces to a sultan's daughter as his bride.

You've probably wished a lot of times for a miracle like this to happen to you. Maybe not for out-of-this-world treasures, but for something that will take care of the things that are bound to come up.

Like medical expenses, or college for the kids. Or maybe just for the nice, safe feeling it gives you to have some extra money put aside for the future.

Though no magic is involved, there is a way to give you this security. The Payroll Savings Plan. Or, if you're not eligible for the Payroll Plan but have a checking account, the new Bond-a-Month Plan.

Either way, it's almost unbelievable how quickly your money accumulates.

Where else can you get such a *safe*, generous return on your money (\$4 for every \$3)? It's so simple—so easy, you hardly miss the money that you're saving.

And don't forget—at the same time, you're *making more!*

Next to a magic lamp, there's no better way than this to make sure your future is secure.

Save the easy, automatic way  
...with U.S. Savings Bonds

Contributed by this magazine  
in co-operation with the  
Magazine Publishers of America  
as a public service.



RADIO NEWS

the vibrator tester is given in Fig. 1.

The test voltage is supplied by a storage battery plus one cell of another battery. This gives about 8 volts across the potentiometer which makes it possible to adjust the input voltage on the vibrator to the desired points for making the tests. A push switch is used in the battery circuit so as to eliminate the possibility of unnecessary battery drain.

The meter with the two series resistors is essentially a two scale voltmeter, 0-10 and 0-500 volts. As you already know, any milliammeter becomes a voltmeter of a higher range when a series resistor multiplier is used.

The rectifier tube may be an 84, 6Z4, 6X5-G or 6X5-GT. The filament leads are run directly to the six volt battery. The filament must not be connected to the four cells like the potentiometer because the heater voltage of any of these tubes should never exceed 7.5 volts. The filament may be connected without regard to polarity.

The load resistor is a 5000 ohm, 50 watt unit. It should be mounted so it doesn't touch either the panel or the cabinet.

The 8  $\mu$ fd. filter is an electrolytic condenser. The positive side of this condenser is connected to the cathode of the tube and the negative to the other side of the load resistor.

#### Wiring Hints

In building this tester there is no set rules of arrangement or wiring. It may be wired with heavy, flexible, insulated hook-up wire, however, all wiring in the primary circuit should be at least No. 14. The primary cable and common lead extending outside to connect vibrators not fitting the sockets should also be large wire. All joints should be soldered.

#### Construction Details

Because of the small space needed for the parts, the vibrator tester may be made into a small, neat unit. It may be built on a wooden, masonite, bakelite, or metal panel and mounted in either a wooden or metal cabinet. The author's tester is made on a 7½" x 10" panel and mounted in a carrying case style cabinet, the kind commonly used for tube testers.

All parts are mounted on the panel. The unit was completely wired before placing in the cabinet. The rectifier tube socket is mounted on the back of the panel near the top so that the tube hangs upside down in the cabinet.

The "on-off" push switch is at the upper left corner, just below the battery cable. The switch marked  $S_2$  on the diagram is at the left of the meter. The input-output voltmeter switch, synchronous interrupter switch, and polarity reversing switch are at the right of the meter. The cables for connecting vibrators not fitting the two sockets come out just below the meter.

## This Month's Specials

### ★ CORNELL DUBILIER ELECTROLYTICS CONDENSERS

40-20 MFD. 150 Volts ..... 10 for \$4.50  
20 MFD. 150 Volts ..... 10 for 3.95

#### F.P. TYPE CONDENSERS

20 MFD. 350 Volts } ..... 10 for \$3.50  
20 MFD. 25 Volts }  
20 MFD. 25 Volts }  
30 MFD. 500 Volts } ..... 10 for 6.90

#### 10 WATT WIRE WOUND RESISTORS

200 ohm ..... 2500 ohm  
20,000 ohm ..... 2700 ohm  
In quantities of 10 ..... \$0.90

#### GENERAL ELECTRIC SPEAKERS—12"

6.8 oz. Alnico 5 slug ..... \$6.95 each  
10" SPEAKERS 6.8 oz. Alnico 5 Slug ..... \$4.75 each

ALL THESE ITEMS ARE FIRST LINE MERCHANDISE.  
ALL FULLY GUARANTEED



**\$35.95**

Immediate Delivery

A Truly 100% Vacuum Tube

### ★ ST. CLAIR VOLTMETER

#### SPECIFICATIONS:

D.C. Electronic Voltmeter.  
6 ranges—0 to 3, 10, 30, 100.  
300, 1000 volts.  
Input resistance 11 megohms.  
Sensitivity—3 volt scale.  
—3,666,666 ohms per volt.  
A.C. Electronic Voltmeter.  
6 ranges—0 to 3, 10, 30, 100.  
300, 1000 volts.  
Input impedance—10.5 megohms  
shunted by 5 micro-micro farads.  
Frequency response flat from 20  
cycles to 2—K.C.  
Electronic ohmmeter:  
6 ranges—0.1 ohm to 1000 meg-  
ohms.

#### TUBES:

200 micro amperes, D.C. of rug-  
ged construction.  
Accuracy—or 2% of full scale.

#### TUBES:

1—6SN7, 1—6H6, 1—6X5.

#### EQUIPMENT:

1—cable "D.C." shielded with  
connector and probe.  
1—cable "A.C." ohms with plug  
and probe.  
1—cable "common" with plug and  
clip.

#### POWER SUPPLY:

105/120 volts, 60 cycle.

We also carry complete lines of Simpson, Superior, R.C.P., and R.C.A. Sound Equipment.

### ★ Complete Line of RESISTANCE TYPE LINE CORDS

Complete line of Resistance type line cords standard 3 terminal AC-DC  
resistance line cords. Prompt delivery. Flexible, sturdy cords, 3 terminal  
type with color coded tinned leads.

135-160-180-200-220-250-290-300-330-  
350-390 ohms.  
.45 cents each. 10 or more .....

42c ea.

### ★ TELEVISION PARTS

Television Receiver, Coil Kit, Video IF, in-  
cluding 10 Matched RF, Oscillator, Video IF,  
Sound IF, Discriminator transformer.  
Sound IF frequency is 21.5 mc. Video 25mc.  
Price for Kit ..... \$4.89

Low voltage power transformer, 700 volt cen-  
ter tapped, 175 MA, 5 volts—3 amp, 6.3 volt—  
8 amp. .... \$9.75 each

Television Manual: design and construction of  
a modern 5" or 7" television receiver, with a  
complete schematic ..... \$1.75

Transformer, high voltage, 2200 volt. to 2 Ma.  
Separate 2.5 volt amp. winding ... \$7.95 each

We carry a complete stock of Radio Parts,  
Equipment, and RCA Receiving tubes. Send  
for our latest catalog, Dept. N.

## Radio Parts Company

612 W. RANDOLPH—Dept. N—CHICAGO, ILL.

*A timely break!*

**MARK TIME SWITCHES WITH A THOUSAND USES**



**\$1.49**

NEW—SURPLUS A FRACTION OF THEIR ORIGINAL COST.

**CAPABLE OF BREAKING 10 AMPERES AT 110 VOLTS, THIS SWITCH CAN BE SET TO SHUT OFF AT ANY SELECTED TIME WITHIN ITS RANGE.**

CALIBRATED IN 15 MIN., STEPS TO 5 HOURS

THIS TYPE OF PANEL MOUNTING SWITCH IS USED BY MANY OF THE LARGEST MANUFACTURERS OF WASHING MACHINES, COOKERS, SUN-LAMPS, AIR CONDITIONERS, MEDICAL AND LABORATORY APPARATUS, VENTILATING FANS, REFRIGERATORS, POWER TOOLS, ELECTRIC FURNACES AND IN A VARIETY OF ELECTRONIC DEVICES.

USE IT TO TURN OFF...

YOUR RADIO, WINDOW OR NEON LIGHTS, SOLDERING IRONS, BATTERY CHARGERS, DAIRY OR POULTRY EQUIPMENT, HEATERS.

CAN BE USED FOR...

VULCANIZING, CLEANING AND DYEING, METAL TREATING, PLATING, TANNING, MOULDING, TEXTILE PROCESSING.

**ZACK**

**RADIO SUPPLY CO.**

INCORPORATED  
1426 MARKET ST. SAN FRANCISCO, CALIF.

**LETTERS** from our readers

**PRODUCT INFORMATION**

**B**EING a subscriber to RADIO NEWS may I draw your attention to a difficulty that arises for those who live in this country.

"Various manufacturers in the United States advertise in RADIO NEWS details of their products and often offer technical details, also catalogues, sometimes requesting postage, sometimes not.

"Here we cannot easily obtain U.S. postage stamps and British ones would be useless.

"I have written to various advertisers hoping they would cooperate, but only one has replied, namely, General Electric Co.

"I appreciate that trading (due to shortage of dollars) between the two countries is limited but that will pass and the time will come when trade will flow once more, then the manufacturers who have been helpful to subscribers of RADIO NEWS will surely benefit.

"My interest in this subject is as a radio service engineer and I do appeal for technical details on American valves (tubes), electrolytic and paper condenser, also vibrators, all of which are seen in prewar and 'Lend-Lease' receivers over here but details of which are indeed difficult to obtain.

"Any help you can give will be appreciated.

"While writing I must congratulate you on the high standard you maintain in RADIO NEWS and say how helpful the articles on test equipment are. Please may we have more and more."

Robert Barlow  
Devon, England

Manufacturers of this country are becoming more and more "export minded" and product information should be more readily available as time goes on.

**MODEL NUMBERS—PLEASE**

**A**S I'VE been servicing radios since 1927, I feel that I have a right to voice an opinion—at last!

"There are many, many, radios on the market that do not bear a model number. Though I do not manufacture radios I can't see that it would incur any great additional expense or hardship if the model number were stamped legibly on each and every chassis.

"If those manufacturers who neglect this slight courtesy to those in the field who service their products, would themselves spend a month in the field, they would certainly find themselves doing a bit of cussing and

might then understand the serviceman's point of view.

"A radio without a model number is worse than a tube without its proper designation.

"RADIO NEWS can do a lot in furthering the cause of the serviceman in this respect by requesting that the manufacturer be 'just a good sport'."

Felix F. Januss  
Los Angeles, California

We highly agree with Mr. Januss. Let's hope that this letter will do some good.

**CORRECTION PLEASE**

**W**ITH reference to the article 'A Universal Voltmeter,' which appears in the June 1947 issue of RADIO NEWS, I believe that you should add a note of correction as indicated below.

"The meter described, if calibrated correctly on sinusoidal alternating voltage, will not indicate correctly on direct voltage (or on most other waveforms, for that matter). As an example, if calibrated on sinusoidal a.c., and if used to measure 115 volts d.c., the meter will indicate 128 volts instead of 115. The ratio is  $2\sqrt{2}$  or 1/11.

"This is sufficiently important to be worth noting so that users of the meter will not be led astray."

J. N. Thurston  
Massachusetts Institute of  
Technology  
Cambridge, Massachusetts

Indeed it is! You are entirely correct in your reasoning. Our thanks to Reader Thurston for pointing out this omission in the text.

**NO, NO, MR. POSTMAN**

**O**N PAGE 60 of the May, 1947 issue of your excellent magazine, the article 'Where Will You Find Them?' mentions the U. S. mailman as a source of forwarding addresses of former customers.

"All local mailmen have always told me that divulging a forwarding address would mean the loss of a mailman's job, and the same is what I have always been told at the post office. What gives?"

Jacob B. Marx  
Cincinnati, Ohio

Far be it from us to fly into the face of post office regulations. If we were wrong on this lead—we are indeed sorry—and hope that none of our readers have impugned the integrity of the postal service by attempting to wring such information from his mailman.

## Servicing Television Receivers

(Continued from page 43)

ment. Consequently television sets will be carefully interlocked to prevent out-of-cabinet operation. In some instances interlocks may also be applied to the capacitance in the deflection plate high voltage system, to short out the condenser when the chassis is removed from the cabinet.

Since these safety precautions are necessary to prevent the possibility of brute force shock and equipment damage, servicemen will have to learn how to check and service dead circuits or train themselves in high voltage safety precautions hitherto unnecessary with voltages seldom exceeding 300. The high voltage hazard will also accentuate the importance of insulation and the position of both components and wiring. Special attention will have to be given to the possibility of leakage and resultant damage to low voltage components.

The cathode-ray tube also introduces a new implosion hazard. Exhausted to high mu, the tube must be protected from rough handling, physical shock, or wide temperature changes in different parts of its glass envelope. Unlike standard radio tubes, the cathode-ray tube is a potential bomb and serious injury to the serviceman and the equipment may result from the careless dropping of tubes during servicing. It should always be removed and replaced with care. It should not be carelessly left on the floor or bench where it may be broken accidentally.

Recognizing the viewing tube implosion hazard, set manufacturers will provide a safety glass shield for the tube face. The purpose of this shield is to prevent personal injury which may result from tube implosion, and to prevent accidental contacts by children, vacuum cleaner handles, and other home hazards. It should never be removed unless absolutely necessary and under no circumstances should a television receiver be returned to the owner without it. The implosion hazard increases with



*Radio Servicemen*  
be prepared  
for FM and TELEVISION  
with  
A NORTHEASTERN  
**Signal Generator**

A general purpose radio and audio frequency oscillator. AM and FM coverage, 160 kilocycles to 140 megacycles. Fixed frequency 400-cycle audio oscillator. Full-vision direct-reading dial. 10 volt a-f output. r-f output from approximately zero to 100,000 microvolts by means of two controls. Low external field. Five bands, calibrated in kilocycles and megacycles and a sixth scale (0-180 degrees) for special calibration.

Rugged construction in steel cabinet with leather carrying handle. Brushed stainless steel panel with etched calibrations. Planetary drive and flexible coupling provide accurate adjustment.

Model 700 — \$59.95  
F.O.B. Manchester, N. H.  
Dept. 5G-3

**ORDER TODAY**  
and send us the  
name of your dealer



**NORTHEASTERN ENGINEERING, INC.**  
MANCHESTER, N. H.

September, 1947

**CURRENT  
CONVERSION**  
WITH **ATR** QUALITY  
PRODUCTS

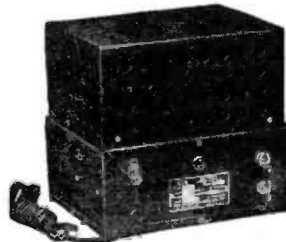

**ATR**  
"A"  
**BATTERY  
ELIMINATORS**

For DEMONSTRATING  
and TESTING AUTO RADIOS

New Models . . . Designed for Testing D.C. Electrical Apparatus on Regular A.C. lines. Equipped with Full-Wave Dry Disc Type Rectifier, Assuring Noiseless, Interference-Free Operation and Extreme Long Life and Reliability.

- Eliminates Storage Batteries and Battery Chargers.
- Operates the Equipment at Maximum Efficiency.
- Fully Automatic and Fool-Proof.
- Type 60-ELIA . . . Rated Output 6.3 Volts at 6.5 Amperes.

Dealer Net Price \$22.80

- Type 120C-ELIO . . . Rated Output 6.3 Volts at 14 Amperes.

Dealer Net Price \$37.20



**ATR**  
**AUTO  
RADIO  
VIBRATORS**

Designed for Use in Standard Vibrator-Operated Auto Radio Receivers. Built with Precision Construction for Longer Lasting Life. Price are approximately 15% lower.

**ATR**  
**STANDARD  
AND  
HEAVY DUTY  
INVERTERS**

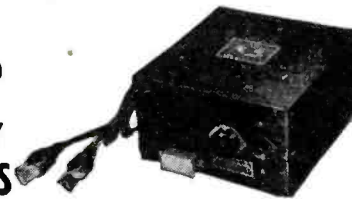

For Inverting D.C. to A.C.  
Specially Designed for Operating A.C. Radios, Television Sets, Amplifiers, Address Systems, and Radio Test Equipment from D.C. Voltages in Vehicles, Ships, Trains, Planes and in D.C. Districts.

Write for New ATR Catalog—Today!

**AMERICAN TELEVISION AND RADIO CO.**  
Quality Products Since 1931  
SAINT PAUL 1, MINNESOTA — U. S. A.

# AMATEURS SERVICEMEN DEALERS! HIGHEST QUALITY LOWEST PRICES

McClintock 0-1 MA Meter—3½"..... ea. \$4.25  
All Tubes JAN Inspected, Individually Boxed

## RECEIVING TUBES

6U4G.....ea. \$0.80	6H6.....ea. \$0.55
6J5.....ea. .54	6SN7GT.....ea. .86
6V6GT.....ea. .89	6E5.....ea. .65
6X5GT.....ea. .55	6AG5.....ea. .98

## TRANSMITTING & SPECIAL PURPOSE TUBES

2X2/879.....ea. \$0.90	3E29/829B.....ea. \$3.00
6AK5.....ea. .89	2C26.....ea. .69
9006.....ea. \$0.85	

## KITS

Resistor Kit consisting of 265—½W, 205—1W, 60—2W. Fully insulated RMA coated, ranging from 47 OHM to 40 MEG OHM. Each type individually packaged \$50.00 value specially priced—\$14.95

Condenser Kit consisting of 185 MICA, Ceramic and molded-paper condensers.....Only \$4.95

## CAPACITORS

Sprague 4MPDX600V Rectangular Can.....ea. \$0.79
Ineco 2MPDX5000V Rectangular Can.....ea. 4.45
Sprague 1MPDX3600V Rectangular Can.....ea. 3.45
Ineco 7MPDX360V Rectangular Can.....ea. 1.69
Micamold 7MPDX600V Rectangular Can.....ea. 1.39
Ineco 2MPDX1000V Rectangular Can.....ea. 1.39

## FILAMENT TRANSFORMERS

(5000 Volt Insulation)

115V 60 cycle PRI. S#1.6.3V @ 5 amp. S#2.2.5V @ 9 amp. S#3.2.5V @ 4 amp.....\$2.95
115V 60 cycle PRI. S#1.6.4V @ 12 amp. S#2.6.4V @ 10.6 amp. S#3.5.0V @ 3 amp. S#4.5.0V @ 3 amp. S#5.5.0V @ 3 amp. S#6.2.5V @ 1.75 amp.....\$4.95

## PLATE TRANSFORMERS

(5000 Volt Insulation)

115V 60 cycle PRI. 2100 V @ 100 MA Secondary...\$8.45
115V 60 cycle PRI. 860 VCT @ 300 MA Secondary... 4.95

## CHOKES

Choke, 59 Henrys—100 MA/850 OHMS.....\$2.95
Dual Choke, 12 Henrys—100 MA/150 OHMS..... 2.45
Drake Jumbo Jewels, Amber and Red.....ea. \$0.59
Circuit breakers, 117V 10 amp.....\$1.75
Circuit breakers, Time Delay Magnetic..... 1.75

## CONNECTORS

2-piece straight with Molded Low-Loss Mica Filled Insert Connector.....\$0.49
Angle Plug Adapter Polystyrene Insert Pin and Socket.....\$0.69
Receptacle Chassis or Box-type Low-Loss Mica Filled Insert.....\$0.49
Hood for R. G. Cables, 80, 100, 110, 220, 630, 650... .15

Minimum order \$2.00, 25% deposit on all orders—balance C.O.D.

ALL MERCHANDISE NEW AND GUARANTEED

# W & H SALES CO.

1815 SO. KEDZIE AVE.  
CHICAGO 23, ILL.  
CRAWFORD 5208

an increase in the size of tube screens. Tubes with larger than five inch faces may implode with terrific force which will demolish both cabinet and the set itself. Obviously anyone in the immediate vicinity is liable to permanent personal injury.

Viewing tubes also present a problem of electrical adjustments unlike those previously experienced in standard broadcast sets. In general all adjustments of the video components are critical. For example, electromagnetic type tubes require ion-trap coils to prevent ion spot and the resultant burning of the tube screen. If the coil is not properly adjusted ion spot trouble may be eliminated but quality of the electron beam may become impaired and result in a poor image. Iontrap adjustment requires the checking of the raster pattern by applying approximately 300 volts to the neck of the cathode-ray tube. The applied voltage must be in proper position with respect to the internal pole pieces and the neck of the tube.

Projection type sets will be equipped with optical systems that will require a basic understanding of optics by the serviceman. While systems similar to those used in cameras and motion picture projectors may be used, a fundamental knowledge of the new Schmidt lens system will also be useful. In view of the high cost of grinding lenses to optical quality, plastic lenses, inexpensively molded may come into general use. Electrostatic attraction of dust in the projection lens system may result in a regular maintenance job. If plastic lenses become standard the serviceman will have to become adept at removing, cleaning, polishing, and replacing relatively soft materials without damage.

Television service will require an expanded knowledge of power supplies for the high voltage, low current demand of the cathode-ray tube deflection system and the relatively high current, low voltage demand for other receiving tube plates and heaters. High voltage supply may appear in several forms including: 1. r.f. high voltage, rectified; 2. flyback supply from scanning coil; 3. standard type, built-up from 60 cycle supply. Each of these high voltage supplies has advantages and disadvantages which will affect the serviceman's problem. The r.f. high voltage rectified type provides the poorest regulation while there is the greatest hazard in the type built-up from 60 cycle supply.

Power supply for the other receiving tubes will be enlarged to supply plate and heater needs for components ranging from sixteen to thirty tubes or about four to six times the current demand for the average AM broadcast receiver. Transformers, chokes, resistors, and wiring will require higher current ratings for satisfactory operation without excessive heating. Where multiple power supplies are used for individual circuit components the serviceman's trouble-

## Priced for Quick Disposal CW-3 WILCOX RADIO RECEIVERS \$13.25 EACH

Express Collect  
While they last—Any Quantity  
Superhet circuit 1900-16500 K.C.; 110 Volt 60 Cycle A.C.; one stage R.F.; B.F.O., noise and sensitivity controls; audio output limiter; rack mounting; complete with all coils; complete set spare tubes; original crates.

Dept. Q  
**AMERICAN MDSE. MART**  
411 Finance Bldg. Philadelphia 2, Pa.

## 12 lbs. SURPLUS ELECTRONIC PARTS \$2.00

A gold mine of parts for repairmen, amateurs, and experimenters... sockets, condensers, resistors, transformers, coils, hardware, wire, etc., etc. An outstanding bargain in usable parts! Send \$2.00 cash, check or M.O. today! (Pay small express charges on receipt.)

## ARMY SURPLUS TU-5-B TRANSMITTER-TUNING UNIT

Range 1500-3000 KC.

Individually cartoned. Component parts value many times this special price of.....\$2.39  
(F.O.B. CHICAGO)

## ELECTRONIC DISTRIBUTORS, Inc.

Dept. A9 620 W. Randolph St. Chicago 8, Ill.

# LCETI



## TRAIN FOR RADIO IN MIAMI

Prepare for a radio career in one of America's most beautiful cities—busy, romantic Miami—at the crossroads of two continents.

Embry-Riddle's internationally known Government-approved School of Aviation offers a full year Radio Course, designed to qualify you for important jobs in the Radio Industry. Approved training under G.I. Bill. Immediate enrollment.

FOR FREE INFORMATION  
MAIL THIS COUPON—TODAY!

Dean of Enrollments—Dept. 55  
EMBRY-RIDDLE SCHOOL OF AVIATION  
Miami 30, Florida

Name..... Age.....

Address.....

City..... State.....

Check One:  Veteran  Non-Veteran



shooting time will be appreciably increased.

The initiation of the average serviceman to television servicing may come through the installation of the set and its antenna. It is in this activity he may make or break his opportunities in the television field. Television sets, unlike standard broadcast receivers, cannot be sold on a take-home, plug-in basis. Because of this, department stores and many other retail outlets will hire servicemen or train their own personnel to specialize in television set installation. How well or how poorly the serviceman does the antenna job will determine the public's attitude toward his ability to perform professional service.

Without a good antenna, properly installed, good television reception cannot be expected. In this way a new market for labor and material is being created for alert servicemen. In instances of apartment house installations as many as four antennas and carefully installed transmission lines may be required. This may create a new need for public relations for radio servicemen . . . to provide the good-will and permission of apartment owners and their superintendents for antenna installation. Outside antennas must also comply with the Underwriters' Laboratories requirements, and in many instances with local ordinances, building codes, and other regulations. -50-

### Reflective Optical System

(Continued from page 56)

Solution of all the above problems culminated in the final development of a projection kinescope—the type 5TP4—having all the desired visual and electronic characteristics for large-screen image projection. The tube is normally operated with a potential of 27,000 volts, providing great brilliance on a high-contrast white-light fluorescent screen. About five times as much light is projected onto the large, final viewing screen as could be delivered from tube to screen by a conventional F:2 motion-picture projector lens without loss of final-image quality.

#### Background

The RCA reflective optical system for television projection is a development evolved from the reflection principles of optical apparatus devised by Kellner and by Schmidt.

Forty years ago, an American lens designer, Kellner, patented a reflective optical system for light transmission by searchlight or by the headlights of an automobile. Twenty-five years later or fifteen years ago, a German optician, Schmidt, invented a camera with a reflective optical system which provided a large aperture ratio and a wide field of view, and was widely used in astronomy.

Entirely unknown to each other,

September, 1947

## MR. RADIO RETAILER

A MUST for NOISE-FREE  
STORE DEMONSTRATION . . .



**PURATONE\***  
SIGNAL BOOSTER

CARRIES AM, FM and TV ANTENNAS ALL ON THE SAME MAST

Increase your radio sales by bringing home-like reception to any AM, FM and TV set in your showroom . . . eliminating all interference and bothersome noises.

**HERE'S HOW:** The Puratone Signal Booster System is easily installed on the roof of your building. A shielded coaxial cable runs directly from the mast to the concealed amplifier on the display floor.

From the amplifier a radiating wire is placed inconspicuously around the display space. No direct wire connection to radio sets required. One system serves any number of floor models. Dual wave traps in the video-type AM-FM amplifier bring in all stations at an average tone-level. 30-40 DB gain on FM; 40-60 DB gain on AM. Effective for any radio department layout.

Write for illustrated circular.

**L.S. BRACH MFG. CORP.**  
200 CENTRAL AVE. NEWARK 4, N. J.

\*Reg. U. S.  
Pat. Office

WORLD'S OLDEST AND LARGEST MANUFACTURERS OF RADIO ANTENNAS AND ACCESSORIES

### ARE YOUR SCR-274-N (or AN/ARC-5) RECEIVERS JUST A MESS OF WIRES AND PLUG TERMINALS TO YOU?

DO YOU WANT SCHEMATICS?  
INSTRUCTIONS? EXPLANATIONS?

Here's a 12-page folder, each page full letterhead size (8½" x 11") with the answers to all your questions. Simplified schematic and explanation of the control and power circuits and all the plugs. Instructions for simple conversion of the blank adapter in front to a local-control adapter, with volume control, on-off switch, and CW-MCW switch. Schematic and parts list for A-C power pack. Complete alignment instructions for RF, IF, and BFO. Top and bottom views with 109 arrows showing parts locations. Voltage and resistance readings to aid trouble-shooting. Schematic of receiver with 3-unit rack, 3-unit control box, and adapters. Three large complete schematics, one each for BC-453-A or -B (same as R-23/ARC-5), BC-454-A or -B (same as R-21/ARC-5), and BC-455-A or -B (same as R-22/ARC-5), each schematic with coil and transformer sub-schematics, parts list, etc. This folder is invaluable, but costs you only two dollars postpaid. Include with your order.

A COMPLETE AND DIFFERENT SET FOR THE  
BC-946-B (R-24/ARC-5) BROADCAST-BAND  
RECEIVER

This set of sheets is also 12 pages, with practical wiring diagram; control-circuit explanation; A-C power pack; top and bottom views with parts-location arrows; schematic, parts list, and complete detailed step-by-step instructions which any beginner can follow to convert the set for a speaker (BFO replaced by audio driver stage), changing the R-F volume control to A-F control and adding delayed AVC; front-end adapter changeover; alignment; etc. Also two dollars postpaid.

SPECIFY WHICH SET OF SHEETS YOU WANT. Print your name and complete address in the upper left corner of the envelope.

**R. E. Goodheart**

2616 N. Spaulding Ave.

Chicago 47, Ill.

## GOVERNMENT SURPLUS

We have on hand a large selection of Radio and Electronic Equipment purchased from the United States Government, and solicit your inquiry on practically any equipment or component parts used by the Army or Navy. Listed below are only a few of the many items we now have in stock.

Indicator I-22A. Selyn with indicating rose, 100 TH power tube, assorted breakers, high-voltage condensers, relay, transformers, etc. Good for antenna and transmitter control and remote modulator basic kit. 110 V 60 cyc.....	\$27.50
Scope, 5" 110 V 60 cycle input. Control unit BC-1286. 15 tubes including 5 CPI. Has all power supplies built in except for 300 Volt amp. B voltage.....	40.00
<b>SAVE EIGHT DOLLARS!</b> Purchase both of the preceding items, packed in original shipping case and crate. Shipping weight 40 lbs.....	59.50
Message Holder, excellent for station logs, regulation letter size 8½x11" with extra clip for holding spare sheets, also protective cover. Reg. Signal Corps type.....	.95
Spark Plug suppressors—6 for.....	.35
Box of 50.....	2.25
Electrolytics, 10x10x10 @ 400 V Mallory FP—can.....	.89
Neon Bulbs, GE ½W 115 V Bayonet Base 150 ea. 10 for.....	1.15
Neon Bulbs, GE ½W 115 V Candelabra base 17½ ea. 10 for.....	1.25
Kit of 100 ½ Watt Resistors, assorted.....	2.49
Relay, 24 Volt, 60 cycle Coil, Contact 15 amp DPST. Normally Open. Ward Leonard.....	1.95
Relay, 2.5 V or 5 V Coil, 60 cycle, Contacts 150 Watt, Guardian Elec.....	1.25
Whip Antenna, 3 removable sections to make 9 ft. Whip w/insulated Mast Base MP-22-A. Constructed to swivel when hit by obstruction. Excellent for Mobile Antenna.....	5.50
TS-13 handset.....	3.95
Linesman's pole climbers.....	4.50
Safety Belt with strap. State belt size wanted.....	5.75
RG8/U Coax, 52 ohm. Polyethylene. Minimum order 25'. Per ft.....	.07
45V Heavy Duty "B" Batteries 8¼x7¼. Date of manufacture May 1945. Carton of 4.....	1.88
Lots of 100.....	.25
6 V Lantern Battery, 2½x2½x3½. Date of manufacture June 1945. Box of 5.....	.98
Lots of 30.....	.13
IF Amplifier, 4 stage. 36 Mc. 1.4 mc. wide. 7 tubes—4—6AC7; 1—6SJ7; and 2—9002. Shipped with tubes and complete set of spare parts, including extra set of tubes. Shipping weight 40 lbs.	19.50
BC-375 100 Watt Transmitter for A1, A2, A3 emission covering 200-500 KC and 1.5-12.5 MC by means of seven plug-in tuning units. The power amplifier is a neutralized class "C" stage using 211 tubes and is equipped with an antenna coupling circuit. Supplied complete with all components, including 28 VDC Dynamotor necessary for an operating installation.....	44.50
SCR-274-N Command Set consisting of three receivers covering (190-550 KC) (9.0-8.0 MC) (6.0-9.1 MC) and two transmitters covering (4.0-5.9 MC) (5.3-7 MC) plus all equipment including modulator unit and 24 VDC Dynamotors to complete an operating installation. Easily converted to 110 Volt 60 cycle operation.....	39.95
SCR-522 Receiver and transmitter. 100 to 156 mc 4 channel AM phone. Complete with tubes. No dynamotor.....	18.95

### SPECIAL \$25.00 OFFER

On a deposit of \$5.00 we will ship you C.O.D. Freight Collect a large quantity of Government Surplus Radio Items subject to your inspection and approval. If, after inspecting, you are not more than satisfied, return to us Freight Collect and all it will have cost you will be freight charges one way. You should be able to dispose of a few of the items that you may not need for the entire cost. This is the cheapest way we can sell you War Surplus Radio Material. Our warehouses are filled with thousands of choice Government Surplus Radio Items. Lots of them we do not have in sufficient quantity to advertise nationally and the cost of inventorying, itemizing, corresponding, etc. would only increase their cost, therefore we make this offer. If you wish to mention a few items you desire we will endeavor to include them in this assortment.

Above Prices F.O.B. Baltimore  
Minimum Order \$2.00

**THE ABELL DISTRIBUTING COMPANY**  
5 E. Biddle Street, Baltimore 2, Md.

SEND FOR OUR FLYER—  
NAME ITEMS INTERESTED IN

the two men had worked independently in their own specialized fields of endeavor and to accomplish entirely different objectives, yet they both developed essentially the same type of reflective optical system.

Since his equipment was used extensively, Schmidt is generally given full credit for developing the reflective optical system as an aid to photographic work in astronomy. However, Kellner's conception of the system considerably predates that of Schmidt.

The successful development of large screen projection for television is the result of a group effort by many members of the RCA technical staff, but a large share of the credit for results obtained is due Dr. D. W. Epstein, in charge of the Optics and Cathode Ray Tube Section at the RCA Laboratories.

While it is too early to state the probable image sizes that will be definitely preferred by the public, there will be produced at least several receiver models equipped with observation screens of a size measuring 18x24 inches, 24 x 32 inches, 30 x 40 inches, or larger—for rooms accommodating large audiences, hotel lobbies, small auditoriums, and the like. The reflective optical system can be used for almost any size of large-screen projection in any type of receiver having sufficient interior cabinet space for mounting the optical elements.

Using essentially the same basic system of projection, large-screen theater-television equipment (Fig. 3) has been designed and used successfully. The optical part of the system includes an extremely brilliant picture tube operating at a potential of 70,000 volts, a 30-inch reflecting mirror, a 2½ inch glass lens to correct for spherical aberration, and a projection screen measuring 15x20 feet. The system embodies the same principles as the basic reflective optical system previously described.

### Into the Future

Future use of projection television, in new models of RCA home receivers, and equipment for large-screen theater projection, will make use of this same, basic system of optical reflection (Fig. 5) with any necessary mechanical modifications and, when developed, any possible improvements in the brightness and efficiency of the system.

Considerable research is now being conducted in the realm of synthetic luminescent materials, to discover a phosphor compound which can be used with much higher operating voltages to produce even brighter television images. This includes improvements in the technique of coating phosphor layers with a thin, metallic film to increase the brightness and contrast of a picture tube.

Other improvements in the projection-type kinescopes will permit, eventually, much higher accelerating voltages and greater beam intensity.

Because of the basic simplicity of

**NOW AVAILABLE!**  
*Full Range Reproduction*



A revolutionary development in amplifiers cleverly designed to defy obsolescence and amazing in its performance. New circuits, new materials and new processes are actually combined in this one amplifier to produce the most satisfying musical amplifier the world has ever known. If you are one of those discriminating persons for whom anything less than the best is a disappointment, you are one for whom the ACA-100DC was designed. Send for technical literature.

**AMPLIFIER CORP. of AMERICA**

398-2 Broadway  
New York 13, N. Y.

## ORDER NOW

BRAND NEW—LM 13

Frequency Meter Boxes, Portable with Canvas Bag. Has many uses for the ingenious builder. Tremendous value..... \$ 1.25  
BC 348 Army Receivers (New Condition)..... \$49.50  
300 Ohm Amphenol Twin Lead, per 100 ft..... \$ 2.90  
75 Ohm Amphenol Twin Lead, per 100 ft..... \$ 2.00  
Kilowatt 75 Ohm Amphenol Twin Lead, per 100 ft..... \$ 7.20  
Complete stock of 80 and 40 meter MON. ITR Crystals in holders, any frequency within 1 KC..... each \$ 2.80  
3 Gang 410 Mmf. Per Sect. Cond. Excellent quality..... \$ 2.95  
National ACN Dials..... \$ 3.00  
2C40 Lighthouse Tube..... \$ 2.95  
2" PM Speaker (Bakelite Cased) Used in Walkie Talkie..... \$ 1.95  
12 Solid Enamel Antenna Wire, per 100 ft..... \$ 1.35  
14 Solid Enamel Antenna Wire, per 100 ft..... .98  
SIREN, Commercial type hand operated, very loud noise, gov't cost \$21.00. Spec..... \$ 4.95

Send for Our Special Bulletin of Government Surplus Items

## DOW RADIO

1759 E. COLORADO ST. PASADENA 4, CALIF.  
Pasadena Phone—SYcamore 3-1196  
Los Angeles Phone—RYan 16683

## TEST OSCILLATOR KIT



at only  
**\$1475**  
complete  
with tubes

Two bands, 180-575 and 575-1800 Kc. 12SK7 ECO 85Z5 rectifier and 991 modulator. Designed and priced to save you money. Kit..... \$14.75.  
Wired..... \$20.25.

Terms—Cash with order or C.O.D. with 20% deposit.  
Send for our new bargain list.

**HALLMARK ELECTRONIC CORPORATION**  
592 Communipaw Ave. Jersey City 4, New Jersey

## ROTA-BASE

NEW HANDY LAB. DIAL actually gives a "prong" picture of radio tube connections. Simply turn the dial to the tube number desired on the ROTA-BASE and complete correct connections are instantly indicated on the "prong" diagram. No more valuable time lost thumbing pages or on lengthy readings. Filament, grid, plate, cathode, etc. to MORE THAN 300 tube types are given. PRICE NOW ONLY \$1.00 postpaid or sent C.O.D. plus postage. Order NOW, money refunded if you are not delightfully pleased.

**REED MFG. CO.** 124 W. 44th St. Los Angeles 13, Calif.

the reflective optical system itself no extensive changes are anticipated in the future. However, general research in the field of optics will continue in an effort to provide optical systems of much greater efficiency.

Essentially the same basic method of optical projection will some day be used for chromatic television, both in home receivers and large-screen theater equipment. In each case, three complete and independent optical systems would be necessary—with countless other modifications. However none of this equipment will be completely developed for a great many years.

Because projection television now provides an unprecedented opportunity for reaching a greater number of listener-viewers *per television receiver*, there is likely to be extensive interest aroused in large-screen television, on the part of advertisers and merchandisers, and by individuals never before interested in the video art.

At such times when lavish musicals, plays, or other high-cost stage productions are televised, a much keener appreciation of the broadcasters' efforts will be possible through large-screen reproduction.

Entertainment and merchandising are but two aspects of television, however, with hundreds of new uses yet to be explored or investigated.

In time, television will be unsurpassed as an important *visual* means of education, enlightenment, observation, exploration, training, and information—a source of culture, truth, and knowledge.

A completely new philosophy of education, *visual* education, can be extended to many schools and countless classrooms, to homes of invalids, and farms in rural districts. The study of trades and crafts and specialized professions will take on new meaning under guidance of skilled artisans, acknowledged experts, and master craftsmen.

In other fields: Wherever vision is needed, television can supply the sight!

Industrial control by means of television is a vast, new, and virtually unexplored sphere of visual endeavor. Television will watch over a hundred industrial machines, control their operation, regulate production, increase safety of human life. Experiments will be observed and regions will be searched where the human eye could not exist. All forms of industrial control and regulation will require projection of collected visual information.

As its many potentialities develop, television will become more than an art, more than an industry. It will be a powerful source of knowledge, thought, and opinion, assuming a dominant role in human affairs. Television will become a great and vital influence in shaping the World of Tomorrow!

-30-

September, 1947

NEW! FOR RECORDING STUDIOS • BROADCASTING STATIONS • THEATRICAL AND ADVERTISING AGENCIES • OTHERS

NEW! FOR RECORDING

# It's NEW! It's PORTABLE!

## It's MASCO'S

ADVERTISING AGENCIES • OTHERS

**De Luxe 16 In.  
Transcription Player  
with Built-in  
5 Watt Amplifier**



TP-16A

Approved by  
Underwriters'  
Laboratories

It has everything required:

- Built-in high fidelity amplifier of wide range frequency response.
- Heavy duty 10" P.M. Alnico V magnet speaker.
- Speaker mounted in removable cover of portable case which serves as an excellent baffle.
- Plays 16" and standard recordings: 12" turntable.
- Operates at either 78 or 33 1/2 rpm.
- Master gain control.
- New low pressure high fidelity astatic Q.T.M. cartridge in No. 400 arm.
- Two input channels, for microphone and phonograph.
- Individual bass and treble equalizers, allowing for accurate tonal settings.

Never before has such a splendid professional disc transcription player been offered at such an outstandingly low price!

Ask your Masco dealer to demonstrate it for you.

List price with tubes \$134.50  
West of Rockies add 5%

For descriptive literature or other information write directly to factory, Dept. N.

MASCO

**MARK SIMPSON MANUFACTURING CO., Inc.**  
32-28 49th Street, Long Island City 3, N.Y.

SOUND SYSTEMS and Accessories

Ravenswood 8-5810-1-2-3-4

## PORTABLE SWITCHBOARDS

**BD-71:** 6 line, local battery, monocord, W/CT, repeating coils on 2 lines to permit simplexing telegraph circuit. New. Price \$40.00 each.

**BD-72:** 12 line, local battery, monocord, magneto type, repeating coils on 4 lines permitting simplexing for telegraph, night alarm bell, carrying strap and 4 collapsible steel legs. New. Price \$60.00 each.

*Discounts for quantity orders*

**MASPETH TELEPHONE & RADIO CORPORATION**

427 Flatbush Avenue Extension

NEvins 8-5709

Brooklyn 1, New York

# Here's News!

Five fully tested "CRAFTSMEN BUILT" products that student-experimenters or experts may buy and use with complete confidence of excellent service.

Mail the coupon below for full information on the products you are interested in.



## SERIES RK 6 2 BAND, 6 TUBE SUPERHETERODYNE RECEIVER SETS

Low cost, new, modern design. Easy construction. High quality reception. A favorite with beginners and advanced students alike. High sensitivity and selectivity. Available in long or short-wave models.

## SERIES RK 8 2 BAND, 8 TUBE SUPERHETERODYNE RECEIVER SETS

One of the finest kits ever produced. This receiver kit makes an ideal replacement for obsolete receivers. Separate 8 inch permanent magnet speaker. Excellent tone quality. High sensitivity, selectivity. A D.E. LUXE instrument at moderate cost.

## MODEL AK 20 HIGH FIDELITY AMPLIFIER KIT

Especially designed for use with AM/FM tuners and for phonograph reproduction. Unit is ideally suited for mounting in cabinet with a tuner or phonograph. Self-contained power supply. Frequency response far exceeds actual needs of FM and phonograph reproduction.

## MODEL TU 6 HIGH QUALITY, AM/FM TUNER KIT

For use where AM/FM reception at its best is desired. AFC circuit to minimize drift. Built in antennas for both AM and FM reception. High sensitivity. Self-contained power supply. Ideal unit for building an exceptional AM/FM tuner at very moderate cost.

**"CRAFTSMEN BUILT" LOUD SPEAKERS**  
Manufactured to highest electrical and mechanical standard using finest grade materials. Available in eleven models. Power range 5 to 30 watts. Highest grade ALNICO magnets. Available in 8, 10, and 12 inch models. Used extensively in high quality radio, phonograph, public address installations.

The RADIO CRAFTSMEN, Inc.  
Makers of craftsman built Products  
1341 SOUTH MICHIGAN AVENUE  
CHICAGO 5, ILLINOIS  
Cable address: "Radcraft"

THE RADIO CRAFTSMEN, INC.  
1341 South Michigan Avenue  
Dept. R, Chicago 5, Illinois

Gentlemen: I am interested in:

Send complete information without obligation.  
Name \_\_\_\_\_  
Address \_\_\_\_\_  
City \_\_\_\_\_ Zone \_\_\_\_\_ State \_\_\_\_\_

## Television Installation

(Continued from page 46)

jam the receiver too close to a wall or other back surface.

Make certain that all tubes are firmly in sockets, and that all grid leads to tops of tubes and all chassis plugs are in place. Often these are jarred loose during shipment. Now, with no lead-in or antenna connected, turn on the receiver. Switch to the channel of a television station that's known to be on the air. Then adjust receiver controls to obtain some sort of picture image, even if it's very weak. (Weak signals are apparent by their lack of brightness *plus* a "snowy" or "spattered" effect over the entire received picture. At this stage of the

installation, such picture weakness is usually normal.)

If signals *cannot* be received and the set is known to be functioning properly, a makeshift antenna may be necessary to check operation of the set. Cut two pieces of any kind of wire, each about 3 feet in length and as straight as possible. Connect a wire to each of the two input terminals of the receiver, to simulate the appearance of a dipole. Some sort of signal should be received, and set controls are adjusted to obtain the best picture possible.

The received sight and sound must be synchronized! *If they are not*, the receiver is definitely out of alignment and therefore would be operating improperly.

All adjustment of the receiver controls should be according to the manu-

## NINETEEN STATION FM HOOK-UP IN EAST

A MODEST promotion program which was designed to display the value of frequency modulation has grown almost overnight into one of the most promising radio hook-ups in the history of the industry.

The Continental Network operating from its home station, WASH, in the nation's capital, is now serving nineteen stations in a six-state area. Utilizing both 8 kc. land lines and aerial pick-ups, this network provides three top Washington features, the Army Air Forces Band, the U.S. Army Band, and nightclub singer Dona Mason, to FM listeners in many Eastern cities.

Land lines are used to connect station WASH with station WFIL-FM in Philadelphia and W2XMN and W2XEA, Major Edwin H. Armstrong's experimental station at Alpine, New Jersey. From Alpine the programs are picked up by either land lines or by air and distributed to outlets throughout the coastal area.

The accompanying map shows the

nineteen station net. Land line hook-ups are indicated by dotted lines while aerial pick-ups are shown by solid lines.

At present the network is operating on a non-commercial basis with special emphasis being placed on selling the advantages of frequency modulation broadcast services. Hook-up costs, even when telephone lines are used, are shared by anyone joining the network. Although the home station is now operating with 650 watts of effective radiated power, it is expected that WASH will operate on 15,000 watts in the near future, at which time it may be possible to eliminate some of the telephone wire hook-ups.

As the first broadcasting relay in the history of FM combining radio and telephone circuits, WASH is not resting on its laurels. New and improved methods of transmission and expanded coverage are currently being sought with the hope that soon a nationwide FM hook-up may be in operation.

-30-

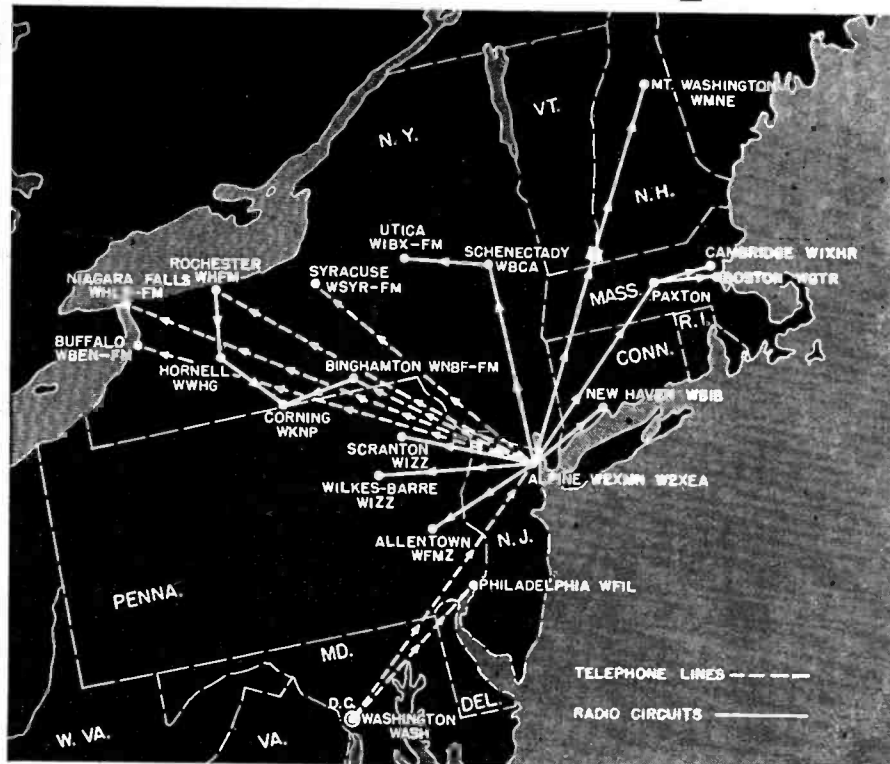

# BUILD YOUR OWN FM TUNER

FM-VARIABLE CONDENSER (88 to 108MC) and complete set of MATCHED COILS with SCHEMATIC CHART AND INSTRUCTIONS for building your own FM TUNER..... **\$4.95**

RADIO TUBES—KNOWN BRANDS—BULK		Each
24, 26, 27, 45, 75, 77, 78		\$0.39
80, 5U4, 5Y3, 5Y4, 35W4, 35Z5		.42
6A7, 6C6, 6D6, 6F5, 6I5, 6J7		.42
6A8, 6H6, 6K7, 6Q7, 6SA7, 6SK7, 6SQ7		.44
12BA6, 12SK7, 25Z5, 25Z6, 35Z3		.44
12Z3, 12BE6, 12SN7, 12SQ7, 12SR7		.47
35L6, 50B5, 50L6, 12AT6, 12SA7		.49
42, 43, 1A7, 1H5, 1N5, 6L6, 6V6, 6X5		.59
OZ4, 7A8, 7B4, 7B5, 7B7, 25L6, 50A5		.65
1R5, 1S4, 1S5, 1T5, 3S4, 3Q5, 1LN5		.74
1LA6, 1LE3, 70L7, 117Z6, 25A6		1.10

PAPER TUBULARS		
.001—600 V.		
.002—600 V.		
.005—600 V.		
.01—600 V.		
.02—600 V.		
.05—600 V.		
.1—600 V. (Per Hundred)		\$6.40
.25—600 V. (Per Hundred)		9.75
.5—600 V. (Per Hundred)		14.50

**\$3.95 PER HUNDRED**

ELECTROLYTICS		(Each)	\$0.15
8—150 V.			.20
20—150 V.			.25
30—150 V.			.26
20/20—150 V.			.44
40/40/20—150 V.—25 V.			.27
8—450 V.			.59
16/16—450 V.			.32
10—450 V.			.36
16—450 V.			.39
20—450 V.			.39
40—450 V.			.54

## DESIRABLE PARTS—The Prices Speak for Themselves

Elec. Phono. Motor, w/9" Turntable	\$2.95
CRYSTAL PICK-UP ARM	1.75
4" PM SPEAKER, Alnico No. 5 Magnet	.95
5" PM SPEAKER, Alnico No. 5 Magnet	1.22
5" DYN SPEAKER, 450 ohms, with output trans.	1.95
VOLUME CONTROLS, 1/2 or 1 Meg, with switches	.39
OUTPUT TRANSFORMER, match 50L6	.39
LINE CORDS, approved, 6 ft., 18 gauge	.14
TOGGLE SWITCHES, SPST	.15
TOGGLE SWITCHES, DPST	.25
TOGGLE SWITCHES, DPDT	.40
AUTO VIBRATOR, standard over 700 Auto Radios	1.45
SOLDER (Rosin) per pound	.55
DETROLA RECORD CHANGERS	13.50
INTERCOMMUNICATION SYSTEM, List \$34.95	17.97
PHONO. AMPLIFIER, includes 3 Tubes	3.70
RESISTANCE CORDS, 160 to 250 ohms	.39
SOLDERING IRON, 100 Watts	1.90
OSCILLATOR COIL, 456KC	.19
I.F. COIL, 456KC	.49
VARIABLE CONDENSER, 2-Gang, 420/162	.68
TELEVISION ANTENNA, List \$14.50	7.25
TELEVISION LEAD-IN, 300 Ohms (per 1000 feet)	19.80
COAXIAL CABLE No. 59U, 72 Ohms (per 1000 feet)	64.20
ELECTRIC PORTABLE PHONO. (3-Tube)	12.95
SELENIUM RECTIFIER	.95
RESISTORS, 1/4-Watt (100 Assorted)	1.50
KNOBBS, (100 Assorted)	4.50
SOCKETS (100 Assorted)	5.00
PILOT LIGHTS (100 Assorted)	4.50
BROOKS INVERTER, 50 Watts—110 V.	8.95
LOOP ANTENNAS, asst. sizes, oval	.29

**BROOKS RADIO DISTRIBUTING CORP.**  
80 VESEY STREET • DEPT. B • NEW YORK 7, N. Y.

**MODEL 208**



Engineered by specialists in the development of broadcast receivers, built in our own modern laboratory. Four times the power of pre-war radio sets. Handsomer in appearance and more efficient in operation. Visual slide rule tuning dial with built-in Regalloop, and super Alnico No. 5 permanent magnetic speaker, with automatic volume control.

#### FEATURES

- Six Tubes—including Rectifier
- Single Band Super-Heterodyne
- Broadcast Band 550 to 1650 K.C.
- Automatic Volume Control
- Wave Trap Rejector
- Super Sensitive Iron Core Transformers
- 5" Alnico Wonder Speaker
- Illuminated Slide Rule Dial
- Built in Regalloop

**\$24.95** LIST PRICE

**MODEL 1049**



Engineered by specialists in the development of broadcast and short wave receivers, built in our own modern laboratory. Four times the power of pre-war radio sets. Handsomer in appearance and more efficient in operation. Visual slide rule tuning dial with built-in Regalloop, and super Alnico No. 5 permanent magnetic speaker, with automatic volume control in the handsomest modern plastic cabinet.

#### FEATURES

- Six Tubes—including Rectifier
- Two Band Super-Heterodyne
- Broadcast Band 550 to 1650 K.C.
- Short Wave 16 to 49 Meters
- Automatic Volume Control
- Wave Trap Rejector
- Super Sensitive Iron Core Transformers
- 5" Alnico Wonder Speaker
- Illuminated Slide Rule Dial
- Built in Regalloop

**\$34.95** LIST PRICE

**MODEL 205**



Engineered by specialists in the development of broadcast receivers, built in our own modern laboratory. Four times the power of pre-war radio sets. Handsomer in appearance and more efficient in operation. Visual slide rule tuning dial with built-in Regalloop, and super Alnico No. 5 permanent magnetic speaker, with automatic volume control.

#### FEATURES

- Five Tubes—including Rectifier
- Single Band Super-Heterodyne
- Broadcast Band 540 to 1650 K.C.
- Automatic Volume Control
- Super Sensitive Iron Core Transformers
- 5" Alnico Wonder Speaker
- Illuminated Slide Rule Dial
- Built in Regalloop

**\$19.95** LIST PRICE

• ALSO AVAILABLE IN IVORY



Size:  
4" wide  
5" high  
8" long

**MODEL 747**

The REGAL Super-Mitel AC, DC or BATTERY. Small enough to be packed in a suitcase, yet uses standard full size components! Parts interchangeable anywhere! The only set of its size with 5 "A" batteries and 1 "B" battery. Average life—100 hours!

#### FEATURES

- 4 1/2" Alnico No. 5 speaker with a heavy duty slug weighing 1.47 oz.
- Selenium rectifier (no rectifier tube necessary!)
- Super-Heterodyne
- Available in six different colors
- Full size 2-gang variable condenser

**\$29.50** LESS BATTERIES

# WARREN DISTRIBUTORS

3145 Washington St., Jamaica Plain 30, Mass.

WRITE FOR DEALER DISCOUNT SCHEDULE



## SCR-625-H MINE DETECTORS BRAND NEW

The U. S. Army used the SCR-625-H Equipment to detect metallic buried mines. For civilian and government applications, there are several ways in which the unit can be utilized.

It is instrumental in uncovering locations of underground or underwater pipes, cables and wires, certain types of ore bearing rock, metallic objects in bulk material such as scrap rubber, buried metal boundary stakes, metallic fragments in human or animal tissue, nails in logs and lumber in saw mills, and the screening of personnel in plants or institutions to uncover the carrying of metallic objects.

Each complete unit consists of a balanced inductance bridge, a two tube amplifier and a 1,000 cycle oscillator. The presence of metal disturbs the bridge balance, resulting in a volume change of the 1,000 cycle tone. The tubes used are low battery drain types: one 1G6 as push pull oscillator, and two 1N5 as amplifiers. A power supply operating from a 110 volt line may be used to operate the unit in commercial operation and installation. The circuit may be modified to operate relays for sounding warnings or stopping machinery when metal is detected.

Each unit is complete with a set of spare tubes, spare resonator, and instruction manual, in a wooden carrying case fully fitted 8 1/2" high, 28 1/4" long and 16" deep. The weight in operation is only 15 pounds. It is ready to operate with the addition of two flashlight batteries and one 103 volt "B" battery.

Each unit is brand new, packed in a hermetically sealed container and then repacked in a wooden export case. Shipping weight is 133 pounds gross, cubic dimensions 6 feet.

Net Price F.O.B. our warehouse

New York

**\$57.95**

All Orders To Be Accompanied by Check or Money Order

**UNIVERSAL MART ASSOCIATES CORP.**  
15 MOORE STREET  
NEW YORK 10, N. Y.

## NOW—A REALLY HIGH-POWERED— Radio Engineering Library

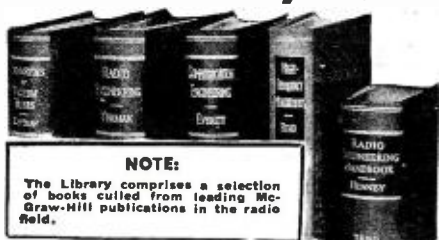

### NOTE:

The Library comprises a selection of books culled from leading McGraw-Hill publications in the radio field.

- especially selected by radio specialists of McGraw-Hill publications.
- to give most complete, dependable coverage of facts needed by all whose fields are grounded on radio fundamentals.
- available at a special price and on easy terms.

THESE books cover circuit phenomena, tube theory, networks, measurements, and other subjects—give specialized treatments of all fields of practical design and application. They are books of recognized position in the literature—books you will refer to and be referred to often. If you are a practical designer, researcher or engineer in any field based on radio, you want these books for the help they give on hundreds of problems throughout the whole field of radio engineering.

**5 VOLUMES, 3559 PAGES, 2558 ILLUSTRATIONS**

1. Eastman's FUNDAMENTALS OF VACUUM TUBES
2. Terman's RADIO ENGINEERING
3. Everitt's COMMUNICATION ENGINEERING
4. Hund's HIGH FREQUENCY MEASUREMENTS
5. Henney's RADIO ENGINEERING HANDBOOK

10 days' examination. Easy terms. Special price under this offer less than books bought separately. Add these standard works to your library now; pay small monthly installments, while you use the books.  
10 DAYS' FREE EXAMINATION—SEND COUPON

**McGRAW-HILL BOOK CO.**  
330 W. 42nd Street, New York 18, N. Y.

Send me Radio Engineering Lib. 5 vols. for 10 days' examination on approval. In 10 days I will send \$2.50 plus 50¢ postage, and \$4.00 monthly till \$24.50 is paid, or return books postpaid. (We pay postage on orders accompanied by remittance of first installment.)

Name .....

Address .....

City and State .....

Company .....

Position..... RN-9-47

158

## • RECEIVERS •



**NC-101XA:** above; Bands 1.7-2.05mc, 3.5-4.0mc, 7.0-7.3mc, 14-14.4mc, 28.0-30.0mc, 11 tube Sup. Het. self cont. 1-stage RF, 2 IF's Hi Q coils CW oscillator AVC xtal filter noise limiter and "S" mtr. Complete L/spkr—\$98.00.

**NC-101X:** same as above, w/PW dial instead of direct reading. New Condition, comp. L/spkr—\$89.00.

**SUPER PRO:** 210 series, comp. w/tubes and power supply—\$135.00; 110 series, comp. w/tubes and power supply—\$105.00.

**HEADSETS:** H-10/GR dual monitoring hi imp fully adj, leather cvrd head band, 5 ft. cord w/PL55 plug on each ear piece. Reg. \$13.50 value, OUR SPECIAL—\$1.49.

**XMITER SPECIALS:** Collins, Harvey, Stancor, and Temco Models, 25 to 1000W—\$49.00 and up. LINK U.H.F. Xmitter and rec. type 5FRX for mobile. New cond. comp. w/phone \$147.50.

**BC-222** Walkie-Talkie L/batt and ant., \$32.50 pair.

**TRIPLETT I-56C:** Tube chkr, set analyzer volt ohm meter comb. w/output mtr and volt ohm mtr, comp. w/prods and adapters, \$72.50.

**SPEAKERS:** Stromberg Carlson 12" walnut cabinet wall type w/baffle and universal matching trans. New, \$22.50.

**FLASHLIGHTS:** TL-122 w/spare bulb L/batt. \$0.59 ea.

SEND FOR SPECIAL LISTINGS ON MICS, TUBES, ETC.

**McCONNELL'S SOUND EQUIP.**  
3834 GERMANTOWN AVENUE  
PHILADELPHIA 40, PA.

manufacturer's instructions for operation of the particular set.

After tests prove the receiver is functioning properly, remove the makeshift antenna. Leave the set turned on, and switched to the same television channel, while preparing the lead-in and matching section.

### The Lead-in

A two-wire lead-in is used between the dipole and the receiver, specially constructed and tuned to deliver maximum signals to the input of the receiver. The two principal types of lead-in are "twin-lead ribbon," and coaxial cable. "Twin-lead ribbon" is often referred to as a *balanced* lead-in. Coaxial cable is known as an *unbalanced* lead-in, because one wire (represented by the *shield* of the cable) is grounded.

"Twin-lead ribbon" (Fig. 3) is the most popular type. It's used in the majority of television installations in suburban and residential districts, and for all other locations where noise interference isn't too great.

Use of coaxial cable is restricted to certain locations which are extremely noisy. Further data on the several types (Fig. 4) will be given in a subsequent article.

Of present concern is the new and popular "twin-lead ribbon," a flexible twin-conductor that actually looks like a narrow, thick ribbon. The two wires are spaced, encased, and thus insulated by a weather-proof plastic known as *polyethylene*. It dries quickly, and stays clean. It's commercially available in several width sizes, determined by the natural *impedance* of the "ribbon." Most useful size for television is the *Federal* type K-1046, which is about 1/2-inch wide and has a 300-ohm *impedance*. You'll need plenty of this lead-in for all types of television installation work. "Twin-lead ribbon" is also available in much narrower widths; one size with 150-ohm *impedance*, one size with 75-ohm *impedance*.

The impedance of the lead-in is important. Every type of lead-in has an impedance, rated by the manufacturer. Every dipole has an impedance at its center point where the lead-in is connected; this is *about* 75 ohms for a simple dipole. The input to the television receiver *also* has an impedance rating, around 300 ohms, but in rare cases it may be 75 ohms.

To receive maximum signals from any television station, the impedance of the receiver and the impedance of the lead-in must be matched or equal, and the impedance of the lead-in and the impedance of the dipole must also be matched or equal.

The input impedance of most television receivers is specified: *300 ohms*. This means that a lead-in *rated at 300 ohms* must be connected to the input terminals of the set. And 300-ohm "twin-lead ribbon" is used.

The center impedance of the dipole, however, is 75 ohms (approximately) and this does *not* match the 300-ohm

## SELSYN MOTORS



**\$2.95**

PER PAIR  
Add 25¢ for Packing  
and Postage

STOCK NO.  
B-407-B

### FOR ROTARY BEAM INDICATION

BRAND NEW - General Railways Signal Co.  
Selsyn Transmitter and Indicator

- Operate from 115 volt 60 cycle thru a 300 ohm 20 watt resistor or 40 watt lamp. (Diagram furnished)
- $\frac{1}{2}$ " long shaft threaded for 6-40 nuts.
- Quick disconnect plugs.
- Small in size ( $2\frac{1}{2}$ " dia x  $4\frac{1}{2}$ " long) and light in weight (20 oz.).
- Other uses - remote indication of liquid levels in tanks, remote wind direction indicators, remote signaling, etc.

TERMS --- Orders under \$3.00, cash with order; orders over \$3.00 require 20% deposit --- balance C. O. D.

**SREPCO**

STANDARD RADIO & ELECTRONIC PRODUCTS CO.  
135 E. SECOND ST. DAYTON 7, OHIO.

## FLASH!

### Attention Hams and S W Listeners

who are owners of SCR-274 and ARC-5 Radio Receivers—we have the missing local tuning control knob which is necessary to tune the BC-946, BC-453, BC-454, BC-455 and Navy versions. This item is contained in a kit which includes: one #1 Phillips Head Screw driver, one metal tube puller and one #6 Bristow wrench with plastic handle. The price, one dollar postpaid, no checks. All items brand new.

**VAN NORMAN RADIO SUPPLY CO.**  
NAPERVILLE ILLINOIS

## Radio Technician and Announcers

A practical 15-month course in First Class Radiotelephone Operation and Announcing is offered by Don Martin School of Radio Arts. Most stations these days require combination men. We specialize in this type of training and maintain a placement bureau for our graduates. Serving the industry for 10 years, the School of Radio Arts can train you. Write for our catalogue outlining the courses offered. Classes can be arranged so you can do part time work on the side.

APPROVED FOR VETERANS

**DON MARTIN SCHOOL OF RADIO ARTS**  
1655 North Cherokee St. Hollywood 28, Calif.

## RADIO MEN

Write for Giant  
BARGAIN CATALOG  
BUYERS SYNDICATE

786 Carew St., Springfield 4, Mass.

impedance of the lead-in. To connect such a mismatch results in loss of signal power and is undesirable in a good television installation. For this reason, a matching section should be used, between the dipole and the top end of the lead-in, to compensate for the mismatch.

A matching section is constructed from a piece of 150-ohm "twin-lead ribbon," and connected as shown in Fig. 5. The length  $L$  of the matching section is determined from Table 1, according to the customer's preferred channels for reception. The length  $L$  is not too critical. Simple connection of matching section to dipole is shown in Fig. 6.

To construct a matching section connecting a 300-ohm lead-in to a 75-ohm dipole, you must first know the Primary and Secondary Channels preferred by customer. Then refer to Table 1, and determine length  $L$  for each of the two channels. Take the average value of these two lengths, and the result will be the best length  $L$  (in inches) for the 150-ohm "twin-lead ribbon" matching section.

For an installation designed to cover all channels, use a length of 37 inches (mean value for all channels) for the matching section.

If the antenna impedance is 300 ohms (in the case of a folded dipole, to be discussed later) a matching section will not be necessary. If the antenna impedance is 75 ohms (approximately) and the input terminals of the receiver are marked 75 ohms, the lead-in should consist of a sufficiently long amount of narrow-width 75-ohm "twin-lead ribbon." Here again, since all impedances are matched or equal, a matching section will not be necessary.

In the overwhelming majority of installations, however, the input impedance of the receiver will be indicated or rated as 300 ohms. For all such cases a 300-ohm "twin-lead ribbon" is used.

From your earlier survey of the customer's house or building, you have estimated the approximate length of the entire lead-in. Add about 20 percent slack to allow for error and to permit later "probing" operations on the roof. Then cut the required length of "twin-lead ribbon" for the lead-in.

If a matching section is required, construct it according to Table 1 and connect this short length of 150-ohm "ribbon" to one end of the lead-in.

Assemble the commercial dipole, according to the manufacturer's instructions for the particular type. Next connect the free end of the matching section to the two metal rods of the assembled dipole (Fig. 6). The distance between rod contacts is not too critical at this time as it will be adjusted later during actual tuning procedure.

The complete antenna, with lead-in and matching section attached, is taken to the roof (Fig. 7).

The lead-in should now be run loosely from the roof to the receiver,

## GET THIS FREE CATALOG NOW



ALL THE BEST  
BUYS IN RADIO,  
HAM EQUIPMENT  
AND P. A.  
SYSTEMS.

### SEND FOR YOUR COPY

of this new free book designed to save you money. Select the new Lafayette radio or famous-make ham equipment you want—at thrifty, low Lafayette prices. Do as thousands today are doing—make the big FREE Lafayette Catalog your buying guide. You save valuable time when you "shop" by mail. And you save real money on everything you buy. Every item in the great Lafayette Catalog is value-priced! Don't be without this book another day. It's FREE—just mail the coupon for your own copy. See what you get!

**YEAR'S BEST P. A. BUY**  
Lafayette 8-watt Indoor System  
Here's Lafayette's value-leader in the low-power field. If you sell P.A.—this system will go like hotcakes. If you use P.A.—it's your chance to save a lot of money.  
MODEL 7015—Complete unit includes: Model 708 8-watt amplifier, complete with tubes. Amplifier has separate mike and phono inputs, output impedances of 8, 15 and 500 ohms. Ten-inch PM speaker. Fabrikoid wall baffle. Crystal mike and stand with 7½-foot cable with end connector. Twenty-five-foot speaker cable. Operates on 110-120 V.A.C., 60 cycles, 65 W.  
**COMPLETE READY TO OPERATE**  
—Your Cost Only \$44.60

## LAFAYETTE Radio

RADIO WIRE TELEVISION INC.

100 SIXTH AVENUE, NEW YORK 13, N. Y.

110 Federal St., Boston 10 ☆ 24 Central Ave., Newark 2, N. J.

LAFAYETTE RADIO, Dept. RJ-7

100 Sixth Avenue, New York 13, N. Y.

Please RUSH big free radio catalog.

Enclosed is Check  Money Order  for PA System

Name.....

Address.....

City..... Zone..... State.....

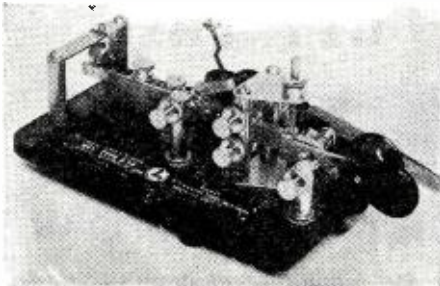

## HIGH QUALITY SPEED KEY \$6.95

NEVER BEFORE, NEVER AGAIN SUCH A BARGAIN. First time on the surplus market. Made by Lionel on the pattern made famous by well-known mfr. of speed keys. Money back if not pleased. BRAND NEW. IN ORIGINAL BOXES. ONLY \$6.95, four for \$27.

TRANSCIVER, RT-7/APN-1, FM, 418-462 Mc. with 14 tubes, diagram. See our ad July RADIO NEWS. New or like new, only a few left at... \$9.88. Instructions now available for converting to use for communication, radio-controlled model planes, etc. Each type. 50c.



### PORTABLE TELEPHONE, EE-8

With handset, generator, ringer, etc. in leather or heavy web case (please do not specify). Requires 2 flashlight cells. Fine for intercom, garage extension, farm phones. NEW... \$15.95. Two for... \$31.00. GOOD USED... \$11.95. Two for... \$23.00. USED, need work 7.95 (FOB Oakland, Cal.)

TUBES, new, orig. cart. guarn. Min. 5 of a kind.			
O2A	\$0.79	6L7	\$0.83
1E5GP bulk	.75	6S7G	.55
1J6G	.72	6SA7	.57
1L6	1.35	6SC7	.57
1L6C	1.35	6SR7	.45
1T4	.79	6SR7GT	.45
3FP7	2.35	6SS7	.45
50P1	4.65	6T7G/6R6G	.65
504G	.45	6U7G	.49
5Y4G	.45	6V6GT	.53
5Z4	.65	7A4	.72
6AR6 (bulk)	.65	7E5	.72
6B8	.52	7G7/1232	.95
6CS6T/G	.47	10Y	.85
6D6	.52	12C8	.65
6F8G	.73	12J5GT	.60
6H6	.47	12SF5GT	.62
6K6T	.53	25Z5	.70
6K7G	.45	37	.39
6K8G & GT	.77	39/44	.39
			9003

TRANSMITTER BC-653A, 2 to 4.5 Mc. 100 watts cw, 22 1/2 watts pbone. See our ad June RADIO NEWS. Govt. cost \$1227. It's a shame to sell these so cheap, but we just have too many. Hundreds of dollars in parts. NEW, w/tubes & diag. \$29

FM TRANSCIVER BC-659H, portable, xtal controlled, 27 to 39 Mc; w/tubes and power pack 1/6 or 1/2 v input; cases rusty, clean inside. If we have any left when this ad appears, they'll go fast. FOB Oakland, Cal. \$8.95

TRANSTAT, Amertran volt. regulator #29145, 11.5 Kva, range 0-115 v, slightly used \$89.95. Postage extra. Minimum order \$2.00. FREE LIST TERMS: Check with order, 25% deposit on COD's.

## ELECTRONIC SUPPLIES

317 East 2nd St. Dept. R-3 Tulsa 3, Okla.

## RADIO ENGINEERING TELEVISION ELECTRONICS

Course in every phase of radio and electronics open to high school graduates. Thorough training, modern courses. Enrollments limited. Approved Veteran Training.

VALPARAISO TECHNICAL INSTITUTE Dept. RS Valparaiso, Indiana

## PEN-OSCIL-LITE

Extremely convenient test Oscillator for all radio servicing: alignment • Small as a pen • Self powered • Range from 700 cycles audio to over 600 megacycles u.h.f. • Output from zero to 125 v. • Low in cost • Used by Signal Corps • Write for information.

GENERAL TEST EQUIPMENT 38 Argyle Buffalo 9, N. Y.

following the most likely route of final installation. This route must be convenient and generally remote from pipes and large metal objects, neon signs, electric switches, motors, and generators. The lead-in may be as long as necessary to avoid these interference pitfalls. Leave considerable slack in lead-in.

Don't install the lead-in permanently at this time. With lead-in connected to both receiver and dipole, recheck operation of the television receiver. Adjust controls for a bright, clear picture on either of the preferred channels.

The *Basic Procedure* next calls for simultaneous work by a technician on the roof with the unmounted dipole and by a technical observer at the receiver. Some means of communication between the two men is necessary. For this purpose use any available two-wire, battery operated telephone system. (Figs. 1 and 2.) Earphone-and-speaker set on roof and similar set at receiver are connected by two wires. Wires can be of any kind or type, but they must be covered to prevent short-circuiting. Allow plenty of slack to permit free movement of the technician over most of roof.

### The Dipole

The most widely used antenna for television reception is the single dipole. It consists of two metal rods placed end-to-end and held in a horizontal position by wooden supports (Figs. 6 and 7). The entire assembly is mounted upright on a wooden pole. The two metal rods are identical.

The *length* of each metal rod is a factor in tuning the entire dipole. By choosing the proper length, at the time of installation, the dipole can be broadly tuned to a preferred channel or group of channels.

The information contained in Table 2 is all you need to determine the best length for each dipole rod to receive *certain* stations operating in your area. Use Table 2 in this way: If only one television station operates in your area, determine the channel number and refer to the second column for the best length (for each metal rod) to receive that channel. If two stations operate in your area, determine their channel numbers and refer to the second column for the best length for the best rod length for each channel. Then take the *average* of the two figures to determine the best rod length to receive *both* stations.

If there are three stations operating and reception of all three is possible, obtain the best rod length for each channel from Table 2. Then take the *average* to determine the best rod length to receive all three stations.

For reception of four, five, or all six channels by a *single dipole*, use a (mean average) rod length of about 41 inches.

Reception from any television station is greatest when the dipole is facing *broadside* to the station's transmitter. Thus, multiple-station

# B 19 TRANSMITTING and RECEIVING SET

3 SETS IN 1-15 TUBES

Complete transmitting and receiving set consisting of "A" Set; "B" Set; "IC" Set; Two Antenna Systems with spares; Five Dynamic Headset-Microphones; Three Control Units with Cables; 12 Volt D.C. Power Supply; Variometer; 15 Spare Tubes; Spare Parts in Case; Instruction Book; and Miscellaneous Items.

This set provides the following facilities:

"A" SET—Transmitting and Receiving from 2 to 8 megacycles, which include the 40 and 80 meter amateur bands. Superheterodyne Receiver and MOPA Transmitter with 807 Power Amplifier, Output 25-Watt-phon and 35 Watts CW.

"B" SET—Radio transmitting and receiving on 230 to 240 megacycles.

"IC" SET—Intercommunication.

This equipment is guaranteed to be brand new.

Price: SET Complete \$48.50

Price: Less 12 Volt Power Supply 39.95

Price: AC Conversion Diagram 50

WE CAN FURNISH ANY ITEM FOR B 19 SETS Terms: F.O.B. Lima, Ohio—25% Deposit on C.O.D. Orders.

## FAIR RADIO SALES

223 S. MAIN STREET LIMA, OHIO

# S.S.S.

"Servicing by Signal Substitution"

Learn about this modern dynamic approach to radio servicing with ONLY BASIC TEST EQUIPMENT.

... Fully described in a 120 page book available from your Precision Distributor or factory at 35¢.

... Schools are invited to inquire regarding quantity orders from our Educational Division.

## PRECISION

APPARATUS COMPANY INC. ELMHURST 9, N. Y.

Manufacturers of Fine Test Equipment RADIO • TELEVISION • ELECTRICAL • LABORATORY

## Mr. Radio Service Dealer

"Speed is our Motto"

One day service on all orders. None too small. Only Nationally Advertised Merchandise (No Surplus Handled). TUBES—Any quantity 50% off list.

Mail us your orders.

Illustrated list on request.

*Bill Sutton's* Wholesale Electronics Fifth at Commerce Fort Worth, Texas

# RADIO

Technician and Radio Service Courses FM and TELEVISION

American Radio Institute 101 West 63rd St., New York 23, N. Y. Approved Under GI Bill of Rights Licensed by New York State



use of a dipole will require some compromise in position or orientation. However, signals can be received from either side of a single dipole.

By adding a directional element, either a *director* or a *reflector*, use of the dipole for multiple-station reception is limited, since the antenna is highly directional. But such arrangements have other advantages, which will be discussed in subsequent articles.

Most important steps in the *Basic Procedure of Installation* are the location, orientation, and tuning of the single dipole antenna.

Details of the procedure are considerably influenced, however, by the size and structure of the customer's house or building and by its *geographical and geophysical location*. As an example, antenna installations in city localities often require more complicated work than installation in suburban districts. For this reason, the remaining portions of the *Basic Procedure* are purposely general, covering all types of installations.

Specific details covering each of the main *types* of installations, *suburban dwellings, city dwellings, apartment houses, and large buildings*, will be treated independently in subsequent articles.

#### Final Work

The best site for locating the antenna is determined accurately by a trial-and-error method, known as "probing."

The assembled dipole, connected to the receiver by a long, loose lead-in, is held upright by technician on the roof (Fig. 1). A second man is stationed at the television set, and observes the received pictures (Fig. 2). The two men communicate by means of the portable telephone sets.

As the antenna is moved through various positions on the roof, the desirability of each site is judged at the receiver—in terms of relative signal strength and picture quality—for both the Primary Channel and the Secondary Channel.

When all likely or accessible areas of the roof have been "probed," the most promising locations are retested, on both preferred channels, until the best, single location for the antenna is found. The site is then marked and the roof technician installs a heavy metal mounting bracket, designed to hold the upright mounting pole. The antenna is then mounted in a semi-fixed position for orientation.

With the receiver switched to the Primary Channel, the technician on the roof rotates the antenna assembly in the mounting bracket while the man at the set observes strength and quality of pictures for various bearings of the antenna.

The best signal is received when the dipole is broadside to the distant transmitter of the television station. On foggy or overcast days, or when the station is just beyond the horizon or when human visibility is otherwise

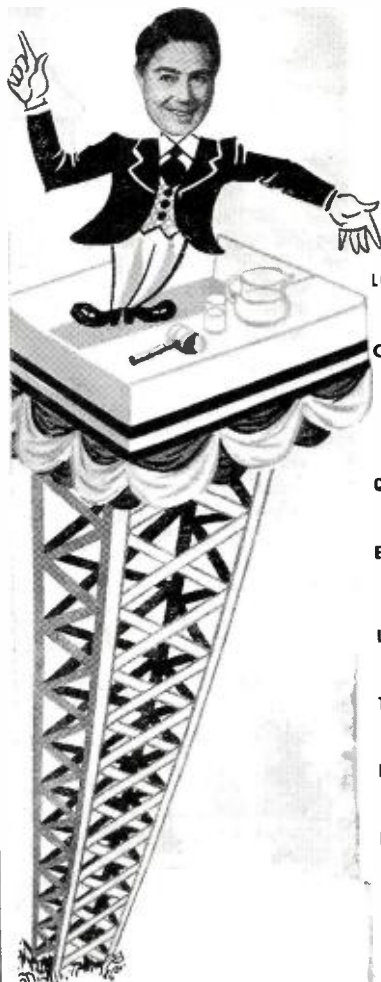

# BOB HENRY'S PLATFORM

#### LOW PRICES

I guarantee to sell to you as cheap as you can buy anywhere.

#### COMPLETE STOCKS

Hallicrafters, National, Hammarlund, Collins, Millen, RME, Pierson, Temco, Meissner, Supreme Transmitters, Meck, Gordon, Amphenol-Mims, RCA, Vibroplex, Sonar, all other amateur receivers, transmitters, beams, parts, etc. If it is amateur or communications equipment—I can supply it.

#### QUICK DELIVERY

Mail, phone, or wire your order. *Shipment within four hours.*

#### EASY TERMS

I have the world's best time sale plan because I finance the terms myself. I save you time and money. I cooperate with you. Write for details.

#### LIBERAL TRADE-IN ALLOWANCE

Other jobbers say I allow too much. Tell me what you have to trade and what you want.

#### TEN DAY FREE TRIAL

Try any receiver ten days, return it for full refund if not satisfied.

#### FREE NINETY DAY SERVICE

I service everything I sell free for 90 days. At a reasonable price after 90 days.

#### FREE TECHNICAL ADVICE

and personal attention and help on your inquiries and problems.

*Order from outside continental U. S. A. also welcomed.*

*Write, wire  
or phone today*

Butler, Missouri **HENRY RADIO STORES** Los Angeles 25, Calif.  
"WORLD'S LARGEST DISTRIBUTORS OF SHORT WAVE RECEIVERS"

## WRCI ELECTRONICS

Graduates now employed as Airline Flight Radio Officers, Broadcast Operators, Merchant Marine Radio Officers, Radio Technicians, radio shop owners. The technical staff and laboratory facilities of WRCI provide superior practical training with modern laboratory equipment. No time wasted on non-essentials. Small classes—uncrowded facilities. Specialized training in RADIO-TELEVISION SERVICING and in RADIO OPERATING. Beginners' classes start monthly. Quota for non-veterans. Approved for veterans. Member L. A. Chamber of Commerce. Free copy of "Lifetime Careers in Radio-Electronics" upon request.  
WESTERN RADIO COMMUNICATIONS INSTITUTE, 631 W. 9th St., Los Angeles 15, Calif.

## VERIFIED SPEAKERS

"They speak for themselves"

WRIGHT  
Inc.

2232 University Avenue

St. Paul 4, Minnesota

# BEST BUYS IN RADIO



## WESTERN ELECTRIC 322 SAME AS ARC-4 144 MC TRANCEIVER

Use this set for 144 mc band, mobile or stationary. Used, but in good condition. With directions for conversion .....\$19.50

6 or 12 volts Ballentyne Dynamo-tor. Output 500 volts, .16 amps. With ARC-4 .....\$4.50  
Separate ..... 6.00

## FM LINK PORTABLE MN3 30-42 MC FM TRANCEIVER

Frequency Modulated 30 to 42 mc. Operates on 6 volts DC or 110 AC, 3 watts. This is brand new and an excellent buy!.....\$250.00

## PORTABLE AMPLIFIER

BC-641 battery powered portable amplifier with speaker, microphone, tripod and case. Used, but in good condition.....\$59.50  
Extra amplifier and microphone with above .....\$15.00

## T-13 HANDSETS

These are getting to be a scarce item. Better fill your need now. Brand New .....\$3.50 each

## T-17 CARBON MIKES

\$1.49

## RM-29 TWO-WAY PORTABLE PHONE

Operates on 4½ volt battery. Magneto Bell call system. In metal cases. Two RM-29 boxes, 2 T-13 handsets only.....\$16.00

## NAVY SOUND POWERED TELEPHONES

Microphone, headset, throat mike. New.

\$9.95 each

Orders under \$5.00, cash. Over \$5.00, 20% with order balance C.O.D. All prices F.O.B. Pasadena. Quantity discounts to dealers.



# FLETCHER RADIO

194 W. Colorado, Pasadena, Calif.

limited or obscured, the direction of a station can be verified by using a small compass.

Antenna position for best signals from *Primary Channel* station should now be noted by man on roof. Then, the entire orientation procedure is repeated for the *Secondary Channel*, to find the best position of the antenna for that station.

To find a good, *average position* of the antenna, permitting very good reception on the *Primary Channel* and fairly good reception on the *Secondary Channel*, switch back and forth between the two preferred channels as the antenna position is varied.

When a strong television station is located in the immediate vicinity, it is sometimes advisable to turn the dipole slightly, favoring a weaker station. In general, whenever a single dipole is used for multiple-station reception, usually some compromise of bearing position is necessary.

After orientation, final tuning of the antenna is accomplished by adjusting the space-separation of the two metal rods of the dipole, while the man at the receiver observes comparative signal strengths. All other tunable factors of commercial antennas are adjusted in the same manner.

When the dipole is located and properly tuned, the position of the antenna is permanently secured at the metal mounting bracket. The weight of the antenna should be sustained by the bracket alone, but guy wires may be used when necessary in the interest of safety.

The "twin-lead ribbon" lead-in is installed permanently. Wherever possible, polystyrene stand-off insulators should be used (Fig. 3) to assure good space separation from surfaces likely to become wet during bad weather.

Small wooden blocks can be used to mount the "ribbon" lead-in but this is not particularly recommended. The "ribbon" can be secured directly to roof or wooden surfaces with fibre-head nails but this procedure gives the least desirable results.

Start this work on the roof at the antenna, and proceed downward, avoiding pipes and large metal objects en route. During installation, the man at the receiver watches picture signals to detect indications of unsatisfactory lead-in positions, such as slight interference from neon signs, motors, etc. Route of the lead-in must be altered, if necessary, to eliminate or minimize such interference or other extraneous effects.

After the work has been completed, remove all slack from lead-in at the receiver. Then reconnect "ribbon" lead-in permanently to input terminals of the set. Install lightning arrestors, and finish all construction work.

The completed television installation should reflect good workmanship as well as technical skill and ability.

These are the *general aspects of the Basic Procedure of Installation.*

(To be continued)

## EXTENDED RANGE EXPANSION! ELECTRONIC ACOUSTIC EQUALIZER!

and your radio, phonograph, public address system, recorder, amplifier, coin operated music machines, motion picture equipment, electronic musical instruments and broadcasting equipment will possess these new and revolutionary features.

**PRESENCE, DEPTH, BRILLIANCE!  
DYNAMIC DISTRIBUTION OF ENERGY!  
HIGH SIGNAL TO NOISE RATIO**

Submit a wiring diagram of your equipment and we will engineer these features to meet with individual characteristics and requirements of your circuits.

We will return your diagram and a complete set of blue prints and specifications including construction data from which you can build this adaptor that will combine all the above features within your instrument.

Send money order or check for \$15.00 to

**NATIONAL ENGINEERING SERVICE**

Post Office Box 1449

LONG BEACH 1, CALIFORNIA

## THE SIMPLEST FM CONVERTER

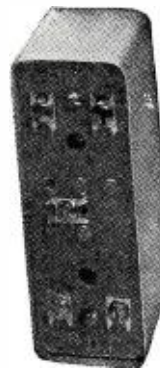

Don't throw away your 10-50 mc. FM tuner! Convert to 88-108 mc. operation with our Model 1002A FM converter. Connects in series with the antenna lead-in at the receiver. No power required. Works with all superheterodyne FM tuners or receivers. List price \$10.00.

Write for Information or See Your Local Parts Jobber

**Crystal Devices Co.**

P.O. Box 380 G.P.O.  
New York 1, N. Y.

Now! GUARANTEED FACTORY REBUILD

### VIBRATORS \$1.00

SEND OLD VIBRATORS. ANY MAKE OR KIND OF VIBRATOR. REBUILD LIKE NEW. NON-SYNCHRONOUS - REBUILD FOR \$1.00. SYNCHRONOUS TYPE - REBUILD FOR \$1.50. INCLUDE SHIPPING AND RETURN POSTAGE. RUSH OLD VIBRATORS TO

**BEST VIBRATOR CO.**  
FOR ORDERS ACCEPTED BOX 5502 - CLEVELAND 1, OHIO

## New Vinylite Frequency Record

33 ½ & 78 RPM; 50 to 10,000 CPS; voice announcements; unmodulated grooves for checking rumble content. Available your local jobber or

**UNIVERSAL RECORDING CORP.**  
20 North Wacker Drive  
Chicago, Illinois

## A. C. 110-VOLT MOTORS

Selsyn Syncro Differential—New in Original Package.

A Bargain at **\$1.75** While They Last.

**LYELL HARDWARE**  
P. O. Box 5 Rochester 11, New York

## Variable Frequency Osc.

(Continued from page 65)

shield dividing the unit in the center. This very nicely isolates the tuning components so that any heat given off by the tubes cannot cause drift.

The tube used as an electron-coupled oscillator should have good screening for the sake of stability. The new type 6BA6 miniature meets this requirement and, in addition, it is small enough so that it can be mounted directly on the shield. Thus, while the terminals of the socket are in the left compartment, actually the bulb or heat radiating section is in the other compartment.

A  $\frac{3}{8}$  inch hole in the shield, originally used for clearing a plate lead, will be found just right for mounting a seven-pin miniature socket to hold the 6BA6.

An *Eby* socket with locking shield was used to insure proper shielding.

As indicated in the schematic the plate circuit is untuned, and consists of a 2.5 millihenry choke. This method is very satisfactory and eliminates the need for a tuned circuit. The isolation or buffer stage consists of a type 6AQ5 miniature beam power tube.

This tube also employs an untuned plate circuit. A .0001  $\mu$ fd. condenser couples the output to an *Amphenol* jack mounted on the rear of chassis and extending through the dust cover. The 6AQ5 is cathode biased so that

## ELECTRONIC SPEED TRAP

THE Department of Highways, Commonwealth of Virginia was recently granted a construction permit for a Class 2 portable radio station to be used in connection with the development and testing of speed meters.

The station which will operate on 2670 and 2455 mc. with .2 watt output is to be used to gather data relative to the speed of vehicles on various highways, incident to formulating control regulations and techniques for sign placement, signal operation, highway marking, and highway design.

At the same time, Automatic Signal Division, Eastern Industries, Inc. of Norwalk, Conn. announced the development of a special type of radar equipment to be used for such checking. Capable of being operated by one man, the new speed meter eliminates the use of tubing across the highway. The equipment weighs about 45 pounds and operates interchangeably from a standard 6-volt automobile battery or 120 volts a.c.

Microwaves are beamed at a car coming toward or going away from the instrument. The radiation is reflected back to the transmitter-receiver and the operator can read the vehicle's speed directly on the linear scale of the instrument's meter. A graphic recorder may also be used in conjunction with the unit.

The manufacturers claim that the instrument will clock cars at speeds from 0-100 miles an hour with an accuracy of within two miles per hour. The operating zone extends for about 150 feet in front of the transmitter-receiver unit.

# BUILD BIGGER PROFITS

with  
**ESPEY**  
CUSTOM  
BUILT  
**CHASSIS**

YES! These ESPEY custom-built radio receiver chassis are really designed to make bigger profits for YOU—the Serviceman and Serviceman-Dealer! They are ruggedly constructed of only the finest materials, and are electronically designed to give your customers maximum reception-pleasure over the years ahead, thereby assuring your reputation as "knowing your stuff!"

Engineered to meet all requirements for an excellent receiver chassis to be installed in your customer's cabinets, these ESPEY models are priced far within the competitive range. With three models to select from, your replacement worries are over. May we suggest that you contact your regular jobber, and examine these sets at your leisure? We feel certain that you will be just as enthusiastic about them as we are!

*In the event that your jobber does not have these chassis as yet, write us for full details!*

## ESPEY MFG. CO., INC.

528 EAST 72<sup>ND</sup> ST., N. Y. 21, N. Y.

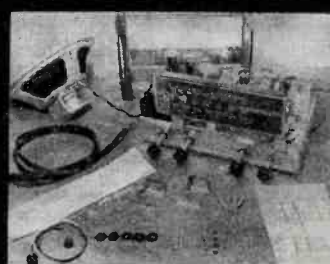

**MODEL 7-B:** 11 tube Superhet AM-FM. For 105/125V AC. Automatic and full range volume controls. 10" Alnico V speaker, wired for phono, AM-FM antennas supplied. RMA listed. Supplied complete, ready to install and operate.

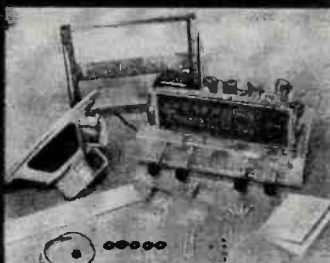

**MODEL RR-14:** 8 tube Superhet. For 105/125V AC. Automatic and full range volume controls. 10" speaker. Covers Broadcast and 2 short wave bands. Wired for phono. Built-in loop. All climates.

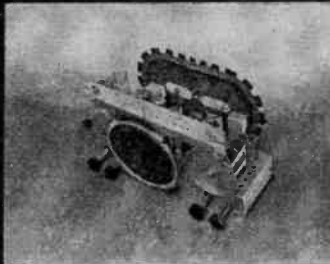

**MODEL 97A:** 6 tube Superhet. 105, 125V AC/DC. 6" speaker. Automatic and full range volume controls. Broadcast and shortwave. Wired for phono. Built-in loop. Tone control. RMA listed. Complete and ready to install.

## RADIO ENGINEERING!

COMPLETE Radio Engineering Course. Bachelor of Science Degree. Courses also in Civil, Electrical, Mechanical, Chemical, Aeronautical Engineering, Business Administration, Accounting, Secretarial Science. Graduates successful. 64th year. Enter Sept., Jan., March, June. Write for catalog.

**TRI-STATE COLLEGE** 1697 College Ave. ANGOLA, INDIANA

DEGREE IN  
27 MONTHS

**NEVER BEFORE IN PRINT**

SEND 3c STAMP FOR POSTAGE

**AMPLIFIER CORP. of AMERICA**

398-2 Broadway • New York 13, N. Y.

20 STEPS  
to PERFECT  
AMPLIFICATION

## SLASH GO PRICES! BARGAINS GALORE!

**TRIPLETT Model 2432 SIGNAL GENERATOR—** formerly \$88.50—NOW only..... **\$69.75**

**ELECTRONIC DESIGNS Vacuum Tube Voltmeter—** with probe—formerly \$59.85—NOW only. **52.50**

**OAK 2-post automatic record changer..... 17.95**

**14 Watt amplifier, complete with 5 tubes... 33.70**

**RADIO TUBES—individually boxed—50% OFF LIST!**

---

**Pocket Size VOLT-OHM-MILLIAMMETER—** with leather handle and batteries—AC-DC Volts 0-1500; Milliamps 0-150; Ohms 0-300,000. Size: 5 1/4 x 3 x 1 3/4".

Formerly \$17.95. SPECIAL—\$12.95

Please Send 25% Deposit with C.O.D. Orders

**SCENIC RADIO & ELECTRONICS CO.**  
53 Park Place • Dept. 55 • New York 7, N. Y.

## TG-10-F AUTOMATIC KEYS

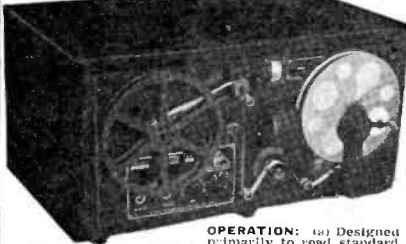

**OPERATION:** (a) Designed primarily to read standard code signals from linked tape by means of a photo electric system and to transmit these signals to a number of headsets or practice tables for code practice.

(b) Can be used as a separate tape puller and take-up unit for use in conjunction with certain types of recorders which do not perform these functions.

(c) Can be used in conjunction with a transmitter and/or Code Recorder BC-1016 to send or relay messages at high speeds (etc.).

**OUTPUT:** Audio signal of 800 cycles. Three output impedances of either 4, 8 or 15 ohms for coil load matching.

**COMPONENTS:** 110 volt Variable Speed Drive Motor—Take-up reel—Practice reel of linked tape—Technical manual—Photo Electric system—25 Watt Amplifier and oscillator circuits Complete with the following tubes: 2-6N7's; 2-6SJ7's; 2-6L6's; 1-3U3G; 1-923.

Complete ready to use in steel cabinet 11" high x 24" wide x 4 1/2" deep, wt. 63 lbs. Designed to fit any standard 19" relay rack. Height is 8 3/4" and weight 40 lbs. when cabinet is removed for rack mounting. Fully equipped and assembled. Just connect to your headphone, etc., and plug into your 110 volt 60 cycle power line.

Surplus—New—Guaranteed

NET FOB, N.Y. . . . \$1995

## UNBELIEVABLE

A TRANSMITTING & RECEIVING SET

NET FOB, N.Y. . . . \$895

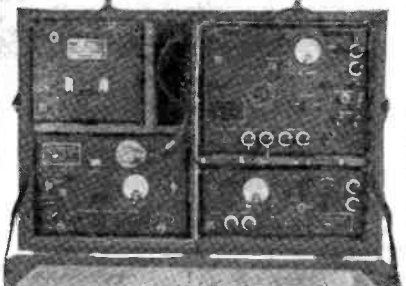

## SIGNAL CORPS S. C. R.—178

2400 to 3750 K.C. Master Oscillator Tuning C.W. Voice-Tune; 3 Watts, 25 mls. Designed in some police, marine, aircraft and amateur bands. Consists of 4 SEPARATE COMPONENTS: Transmitter, Receiver, Modulator and Battery Box. Receiver operates separately on standard radio A, B and C batteries. Transmitter operates from any external source of 8 volts at 3.25 amp. and 500 volt at 100 M.A. Set uses the following tubes: 1-#10; 1-#865; 2-#34; 4-#90.

To be put COMPLETELY into operation you require only the following: Batteries, tubes, headphone, mike, key, antennae, and power source for transmitter.

In this set are 3 meters: 0-1 Amperes R.F.; 0-200 Milliamperes D.C. and a dual range 0-3.5 and 0-140 D.C. Voltmeter. THE COMPLETE SET CAN BE PURCHASED FOR ONLY THE PRICES AT WHICH WE NORMALLY SELL ONLY THESE THREE METERS \$8.95. F.O.B. N.Y. This set is worth many times this special price as it can be readily modified or used for the valuable parts it contains.

Condition: Guaranteed New—Never used, not re-fects—in perfect operating condition. Made by Allen B. D. Mont Laboratories, Inc. Shipping wt. 80 lbs. Dimensions: 25" x 17 1/2" x 10 1/2"

What's the hitch? There is none! We SPECIALIZE IN ALL TYPES OF METERS but do carry various components such as this from time to time. We have only 390 of these units left in stock and we won't have them long; at this amazingly low price so get your order in while the getting is good.

## BC-1072-A RADAR TRANSMITTER

150 to 210 Megacycles; Operates off 115 volt, 60 cycle power line. This unit can be adapted to a 2 meter band transmitter but its chief value is for the parts it contains.

**BLOWER:** 115 volt 60 cycle 28 watts .38 1525 R.P.M. A.G. Redmond.

**VARIAC:** Gen. Radio type 200 B 115 volt input. 135 volt 1.5 amps. Max. output.

**TUBES:** 2-5U4G's; 1-607; 1-2X2; 1-6SN7; 1-813; 1-0002; 2-0006; 2-826.

**METER:** Simpson, 3 1/4", round, 0-5 Kilovolt and 0-10 M.A. D.C.

**TRANSFORMERS:** 1—with primary variable from 0-135 volt, secondary from 0-3500 volt; 1—with primary 117 volt secondary 6.3 V at 1.2 Amp. 27.5 volt center tap to each side, 5.0 volt at 3 Amp.; 1—with 117 volt primary, secondary 2 volt at 18 amp. and 2.5 volt at 1.75 amp. Consists also of many other parts, relays transformers, circuit breakers, interlocks, resistors, chokes, too numerous to itemize.

Complete in metal cabinet 18"x20"x17 1/2"; net wt. 150 lbs.

NET FOB, N.Y. . . . \$2250

SEND FOR FREE CIRCULAR  
**MARITIME SWITCHBOARD**  
 336 Canal Street New York 13, N. Y.  
 Worth 4-8217

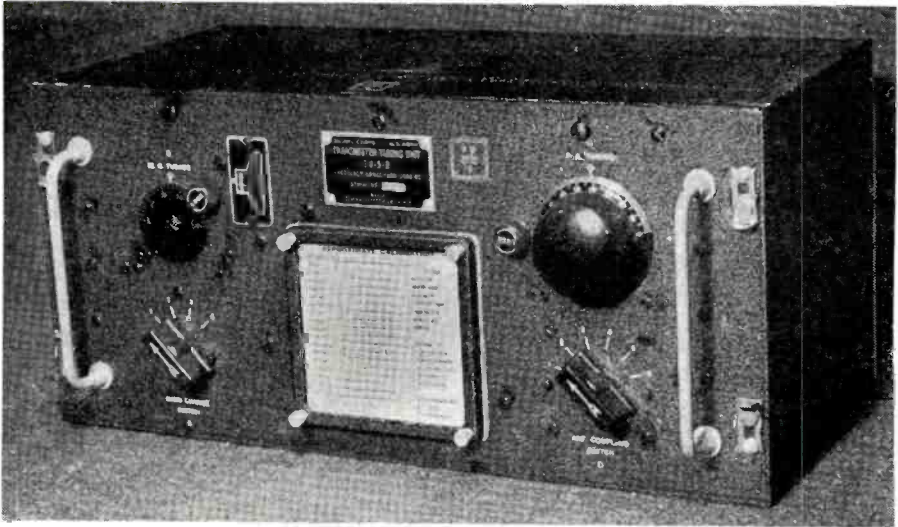

Panel view of the original tuning unit, TU-5-B, as it is obtained from war surplus.

its dissipation does not become excessive when the e.c.o. is turned off.

The 6BA6 plate and screen potentials as well as the 6AQ5 screen are held to close limits by the VR150 regulator tube. The 6AQ5 plate is supplied direct from the filter output, ahead of the regulator. With the e.c.o. turned on and oscillating, resistor R<sub>1</sub> should be adjusted so that the current flowing through the VR150 is approximately 17 milliamperes. This setting is most conveniently made by temporarily connecting a milliammeter in series with the VR tube's cathode.

The power supply, together with the 6AQ5 tube, is mounted on an aluminum shelf which is mounted in the original unit by means of four small angle brackets. The calibration chart, originally mounted in the center of the front panel, is relocated near the right end of the panel. This is done to cover up several holes that are exposed in the panel by the removal of a variable condenser. Incidentally, this chart is ideal for the v.f.o. calibration chart.

Removing the neutralizing condenser from the center of the panel also left a small slot in panel. This slot was enlarged so that a pilot light bracket

could be mounted. Other small screw holes in the panel were filled up with black-head bolts which were left over from parts removed from the original unit. An "on-off" power switch may be added but it has proved more practical to have the v.f.o. power supply and heaters come on when the station's receiver is turned on. Very little additional power is consumed and it insures stable operation at all times. A toggle switch connected in parallel with the rear keying terminals of the e.c.o. affords a convenient means of making the e.c.o. operable without throwing the station's transmitter on the air. In this way the v.f.o. may be set to the desired frequency prior to going on the air.

The e.c.o. follows a bug beautifully with no noticeable chirp. If a chirp develops it may be necessary to decrease the value of C<sub>s</sub> screen bypass. However, the .01 μfd. should be correct.

Placing four Lord shock mounts on the bottom of cabinet completes the job.

The builder will find this unit compares very favorably with commercial v.f.o.'s now on the market.

-30-

Under chassis view shows location of component parts in the completed v.f.o.

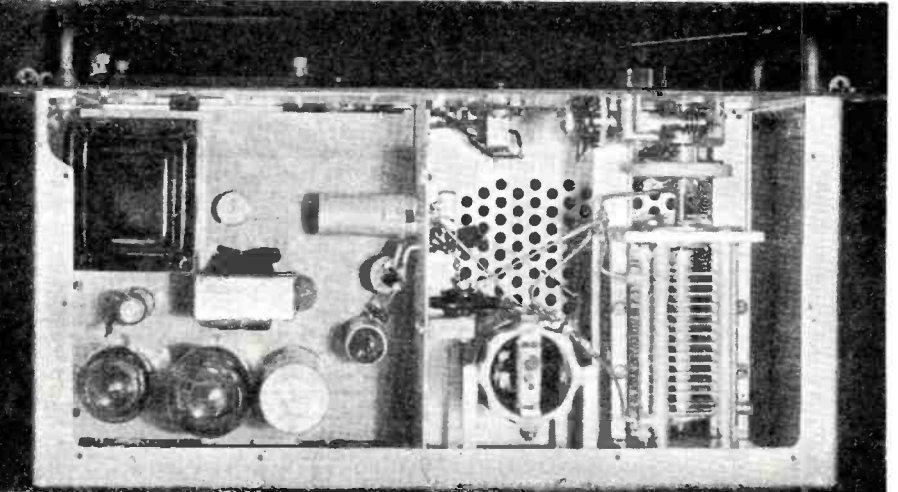

## New Radio Outlet

(Continued from page 47)

it pays off—didn't they sell 2000 Eddie Howard records in one weekend when he was making a personal appearance in Peoria?

The story told in the window is a continued one, for when the customer steps into the store the floor displays take over the job of selling. A long record rack, capable of housing 175 albums, extends along one side of the store. Special sections of this display are given over to classical and to juvenile albums. Single records are also allocated space on this display with over 2000 titles on hand to tempt the prospective customer.

Table model combinations and radios are grouped together in a special display fixture near the record department. Adequate provision has been made for connecting each and every receiver so that it can be demonstrated on the spot without the necessity for carrying the merchandise to an outlet. By having merchandise of similar type grouped together step-up selling becomes relatively easier and increased profits will result.

Consoles are displayed on a four-inch high platform at the rear of the store. This arrangement permits customers to view the merchandise in a favorable setting without being disturbed by heavy store traffic. Each week one console is featured in a special setting which simulates a "home" atmosphere by the use of lamps, pictures and end tables.

Hiding all this "light" under a bushel is not in keeping with the policy of the store—so they tell their public about the merchandise in display ads which tie-in with their window displays; tiny two-inch ads which appear daily and keep the company's name and products before the public; monthly direct mail campaigns which consist of folders, circulars, and booklets furnished by manufacturers; monthly lists of new records; a 25-minute program, "Platter Parade" which is aired each Saturday evening and features the newest discs handled by the store; and personal solicitation by trained personnel.

In addition to these market-wise techniques the store dares to be different by staying open evenings until 9 p.m. Believing that many radios and appliances are purchased as a result of husband-wife shopping, the store makes it easy for the family to select new merchandise for the home. The large proportion of the store's business which is done in the evening seems to justify the owner's stand on this point.

Thus, in various ways, *Smith & Aplegate* have made a success of their business because they have anticipated their customers' needs and have dared to "be different."

-30-

September, 1947

# Everybody refers to the

# RADIONIC

## Catalog!



... BECAUSE IT'S ONE, COMPLETE, COMPREHENSIVE, RELIABLE VOLUME

**W**E ARE a well staffed organization equipped to deliver anytime, anywhere, all types of radio and electronic equipment. An aggressive Purchasing Department keeps our shelves well stocked with the very latest in parts and units. An intelligent and courteous Sales Force is anxious to make these available to you with genuine interest and cooperation. An alert Shipping Staff endeavors to deliver your order safely, surely and speedily.

### Chancellor RADIO

RADIOS • TELEVISION SETS & COMPONENTS  
INTERCOMMUNICATORS • RECORDERS  
PUBLIC ADDRESS • TUBES • HARDWARE  
RECORD CHANGERS • TECHNICAL BOOKS  
TEST INSTRUMENTS • PARTS & ACCESSORIES

## RADIONIC EQUIPMENT COMPANY

DEPT. 59  
59 TRIBUNE THEATRE ENTRANCE  
170 NASSAU ST., N. Y. 7, N. Y.  
CABLE "CHANSLOE" WOrth 2-0421

Send TODAY for this Free Radionic Catalog. Save yourself purchasing time and dollars in the bargain. All merchandise is guaranteed, backed by our international reputation for fair dealing.

## MAIL TODAY

**RADIONIC EQUIPMENT CO.**  
Dept. 59, 170 Nassau St., N. Y. 7, N. Y.

Gentlemen:

Please send your Free Catalog No. 47, listing products of leading manufacturers of radio electronic parts and equipment; also, all literature as published.

Name.....

Street.....P.O. Box.....

Town.....Zone.....State.....

## AUTOMATIC IRON TESTER

Pilot light flashes on and off with thermostat

Invaluable for checking temperatures, accurately resetting thermostats. Registers in fabric graduations—Rayon, Silk, Wool, Cotton, Linen. Also in degrees, 200° to 700° F. Has a specially designed precision thermometer, unsurpassed in quality, accuracy and performance. ONLY \$18.50 postpaid. MONEY BACK GUARANTEE. Write for circular.



(Pat. appl. for)

**HANLAN CO.**

1419-C, West Jefferson  
Los Angeles 7, Calif.

SERVICEMEN—HAMS—EXPERIMENTERS  
NO WE DON'T!!!  
HAVE

FANCY CATALOGUES  
WAR SURPLUS  
FREE PREMIUMS

BUT WE DO

Wholesale the Finest in Radio and Electronic Components and Equipment at the Lowest Consistent Prices

WRITE—WIRE—CALL  
**STANDARD ELECTRONICS  
DISTRIBUTING CO., INC.**

Dept. N-9  
1497 Main Street Buffalo 8, N. Y.  
GARfield 5000

# UNGAR Points

## THE WAY TO BETTER SOLDERING

### A LITTLE IRON THAT WILL DO A BIG IRON'S WORK



No. 536 Pyramid Tip, made from Tellurium



No. 537 Pencil Tip, made from Elkaloy A. Tip 1/8" dia.

Built for speedy accurate soldering, this powerful little pencil iron will perform rugged heavy duty jobs as well as those requiring intricate exactness.

*Check these points!*

- QUICK HEATING . . . 90 SECONDS
- LIGHTWEIGHT . . . . 3.6 OUNCES
- HANDY SIZE . . . . . 7 INCHES
- SAVES ELECTRICITY . . . 20 WATTS



No. 539 Chisel Tip, made from Tellurium



No. 538 Chisel Tip, made from Elkaloy A. Tip 1/8" dia.

*Light as a feather*



*Perfect balance*

**UNGAR Electric Tools Co.**

BOX 2255, TERMINAL ANNEX - LOS ANGELES 54, CALIF.

SEE YOUR NEAREST RADIO OR HOBBY DEALER

## Television Counters

(Continued from page 53)

ing only when the trigger tube fires. When the first section is conducting the plate current flows and discharges condenser C<sub>2</sub> so that it is ready for the next step count. Output is taken off of the second section plate in the form of a long duration negative pulse.

### Blocking Oscillator Counter

Another type of counter used in the sync generator is the blocking oscillator type shown in Fig. 6A. The blocking oscillator is an arrangement of charging diodes and condensers. The step charge condenser is in the grid circuit of the blocking tube. The blocking tube itself does not produce continuous oscillations but only produces bursts of oscillation when the charge on the condenser is sufficient to drive the tube into conduction. The blocking tube is normally biased beyond cut-off by the positive voltage applied to the cathode. The voltage on the grid condenser builds up in steps and finally reaches a value which is sufficient to drive the blocking tube into conduction. Instantaneously, a sharp burst of plate current is produced because of the transformer feedback. The positive going grid voltage now draws grid current and discharges the step charge condenser. Immediately the positive grid voltage is removed and the tube is once again beyond cut-off. It is held beyond cut-off by the positive voltage applied to the cathode until another step charge is built up on the charging condenser. Consequently, a number of applied pulses are necessary to build up the charge on the condenser to a sufficient level to produce a burst of plate current in the blocking tube circuit. Thus the circuit serves as an efficient counter. The actual count down can be adjusted to some extent by the potentiometer in the cathode circuit of the blocking tube. The more positive the cathode bias the more steps are necessary to build up the charge on the condenser to a level which will cause the tube to conduct. Again the voltage differential between the step levels becomes increasingly smaller as the number of steps and the charge level of the condenser rises.

A new circuit innovation discussed by C. E. Hallmark of Farnsworth at the I.R.E. Convention of 1947 permits a step voltage of equal increments to be developed across the charging condenser. With an equal increment step voltage on condenser C<sub>2</sub> count down ratios of twenty-five-to-one and higher can be expected. In a sync generator with this type of counter only two units, one with a twenty-five-to-one and a twenty-one-to-one count down ratio, are needed to count down from the double line frequency of 31,500 to the field rate of 60.

In this type of circuit, shown in Fig. 6B, the discharge or restorer tube is a

## RISCO HAS IT

### THE PARTS AT THE PRICES

#### V. M. MIXER CHANGER

\$15.50

PLAYS 10" and 12" Records at the same time.

Seeburg \$21.00  
 Detroit. 13.75  
 Oak 2  
 Post. 17.00  
 G.I. 14.50  
 Magniv. 13.00  
 Walnut Base. 4.00

Above Easily Attached to Any Radio or CAN BE USED WITH AMPLIFIER BELOW

#### MAKE YOUR OWN RECORDS WITH RISCO 3-WAY HOME RECORDER

5 Minutes Recording on a 10" Record  
 10 min.-dual speed  
 Ready to operate with

6" Spkr., Crystal Mike \$49.50

\$5.00 extra for dual speed recorder

#### G.I. Dual Speed Mechanism . . . . \$26.50

1. Ideal for music lessons, parties, your child's cute sayings, etc.
2. High quality phono.
3. High output for a public address.

Write for details.

ASTATIC L-70 or SHURE GLIDER CRYSTAL PICKUPS

ASTATIC L-70 Cartridge. \$1.45

\$1.79

ASTATIC Nylon Cartridges \$3.25

#### PHONO AMPLIFIER

3 TUBE AC-DC

Wired Vol. & Tone \$2.95

Control. . . . . \$3.25

Uses 12SQ7, 6X4, 6X5

Complete with 3 tubes and 5-inch speaker in kit form. \$7.50

Will drive a 6"-8" Spk. Wired and tested. . . \$8.00

VISIT OUR SHOWROOM

Orders filled as soon as received.

25% on C.O.D. Orders to United Acct's

VETERANS TO SERVE YOU—FREE CATALOG N.R.

**RISCO ELECTRONICS**  
**WHOLESALE DISTRIBUTORS**  
 22 Warren St., New York 7, N. Y.

## NEW F. M. TUNER!



Here is what you have been waiting for to attach to your present amplifier or radio to give you staticless, quiet radio reception characterized by the Frequency Modulation method of transmission.

The new 11 tube COLLINS FM tuner is supplied as a chassis unit, with rack panel or in attractively styled cabinets (illustrated) presented in a variety of leatherette finishes. Its utility is therefore three-fold in being readily adaptable to any existing set-up: console mounting, recording studios and broadcast stations or in the living room of your home, blended perfectly with the surroundings.

Not a competitive tuner but the best.

See your local jobber and if he cannot supply you write us direct.

**COLLINS AUDIO PRODUCTS CO., INC.**

126 PARK ST. WESTFIELD, N. J.

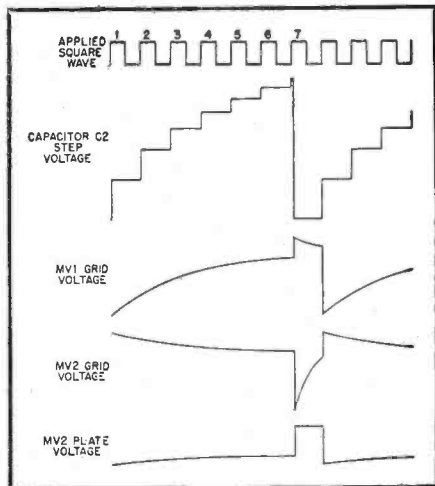

Fig. 7. Step counter waveforms.

triode and counter condenser  $C_2$ , is not permitted to discharge to zero during the negative alternation of the applied pulse. The level to which the condenser discharges is a function of the d.c. resistance of the triode. Inasmuch as the d.c. resistance of the tube is a function of the grid bias, this resistance can be varied. Thus, as the level rises across the condenser  $C_2$  as it is step charged, the level to which  $C_2$  is discharged also varies so that for each new positive alternation the charge added to  $C_2$  is the same as the previous one. Thus, the step voltage increment on condenser  $C_2$  between the 20th and 21st pulse is the same as it was between the 2nd and 3rd pulse. It is evident there is no more likelihood of the circuit jumping count at the 21st pulse than there is at the 2nd or 3rd pulse.

#### REFERENCES

- Fink: "Principles of Television Engineering," McGraw-Hill Book Company.  
 Bedford & Smith: "Precision Television Synchronizing Generator," RCA Review, July, 1940.  
 Hallmark, C. E.: "Counter Timer for Television," Radio-Electronic Engineering Edition of RADIO NEWS, July 1947.

—30—

#### CASE FOR SMALL PARTS

**S**MALL repair parts commonly used in servicing radios, such as dial cord springs, fuses, nuts and washers are easily carried in a spectacle case as shown.

A small screwdriver and tweezers may also be carried in the case—which will fit in most any pocket . . . H. L.

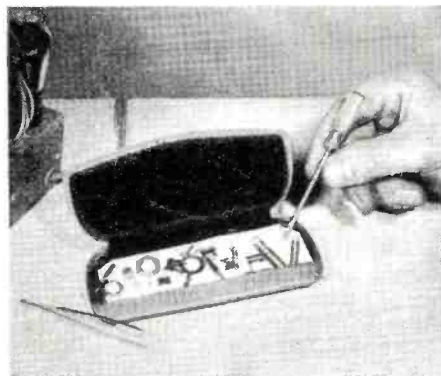

## PARTS AND EQUIPMENT SPECIALS!



#### MEISSNER AM-FM TUNERS

Covers the FM band from 88 to 108 MC. At 103-125 volts, 50-60 cycles, power consumption is 80 watts. Tubes: 9003 R.F. amplifier; 6BE6 oscillator-converter; 2-9003 I.F. amplifiers (456 KC); 6AL5 detector for the AM section. For the FM Section: 6AG5 R.F. amplifier; 6C4 oscillator; 6AG5 converter; 3-6AG5 I.F. amplifiers (10.7 MC); 2-90D1 limiters; and 6AL5 detector. Two 6C4's are used for audio amplifiers, a 6U5/6G5 for tuning indicator and 5Y3GT-G for rectifier.

Now Available for Immediate Delivery. Write for Prices.

#### BROWNING FM-AM TUNERS

Receives both old and new FM band (87 MC to 109 MC) and standard broadcast band (530 KC to 1650 KC). 115 volt 60 cycle operation. Tubes: one 6BE6, one 6C04, one 6BA6, one 6SG7, two 7AG7, two 6SJ7, one 6H6, one 6SA7, one 6SP7, one 6E5 or 6U5 (tuning eye).  
 Net Price . . . . . \$143.90  
 POWER PACK for above . . . . . 15.73



#### The MEISSNER RADIO-PHONO-RECORDER

Portable Radio, Recorder, and Public Address System. 7 tubes. High fidelity crystal-cutting head for 10" records. Excellent crystal microphone. Dual turntable speeds, 33 1/4 and 78 r.p.m.

Now Available for Immediate Delivery. Write for Prices.  
 25% Deposit on All Orders

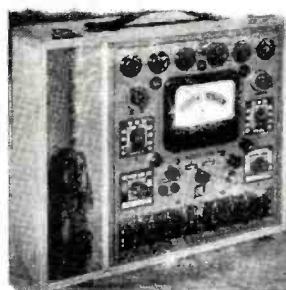

#### Electronic Measurements Corp. SERIES 200

#### MUTUAL CONDUCTANCE TUBE CHECKER

- Model 200 AC 3" meter in sloping counter case . . . . . \$49.85
- Model 200 AP 3" Meter in hand rubbed carrying case . . . \$53.85
- Model 200 BC 4 1/2" Meter in sloping front counter case . . . \$52.85
- Model 200 BP 4 1/2" Meter in hand rubbed carrying case . . . \$56.85

Here for the first time is a true mutual conductance type tube tester with complete flexibility, and at a price no higher than that charged by other manufacturers for the ordinary emission type.

#### CHECK THESE FEATURES!

1. Checks mutual conductance on a calibrated microhm scale, as well as on a REJECT-GOOD scale.
2. Checks five element tubes as pentodes.
3. Checks tubes for gas content.
4. Detects both shorted and open elements.
5. Complete switching, flexibility allows all present and future tubes to be tested, regardless of location of elements on base.

#### GUARANTEED ELECTROLYTIC TUBULAR CONDENSERS

- Sprague 16 MFD 450 v. ea. . . . . 49c
- Mallory 40x20 MFD 150 v. ea. . . . . 49c
- Solar .01 MFD 400 v. per 100 \$7.00
- 8 MFD 450 v. . . . 10 or more. ea. . . . 25c
- 20 MFD 150 v. . . . 10 or more. ea. . . . 26c

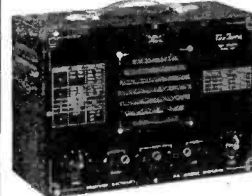

#### SOMETHING NEW IN TEST SPEAKERS

No need to carry the speaker to your shop in servicing any radio from the small midget to the most elaborate console. A n.v. output tube or tubes can be matched simply by rotating input switch to tube listed on the front panel and rotate field switch for proper impedance and proceed with testing. External voice coil connection permits testing of net speaker to determine if output-transformer is open or shorted. Field Impedance: 500, 1000, 1500 and 2500 Ohms.

\$19.95

#### OUTDOOR AERIAL KITS

Complete with 25 ft. lead-in wire, 50 ft. antenna wire, ground straps, glass insulators and nail knobs. Each . . . . . 69c

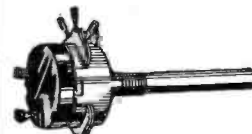

#### New Standard REPLACEMENT CONTROLS

for Superior Performance with S.P.S.T. Switch

Cat. No.	Ohmage	Taper
501	10,000	Ant. "C" Bias
502	20,000	Ant. "C" Bias
503	50,000	Voltage Divider
504	100,000	Linear
505	1/4 meg.	Audio Taper
506	1/2 meg.	Audio Taper
507	1 meg.	Audio Taper
508	2 meg.	Audio Taper
516	1/2 meg.	Linear Taper
517	1 meg.	Linear Taper
518	2 meg.	Linear Taper

CHOICE **69c** EACH

F.O.B. Chicago

**The Radio Shack Inc. OF CHICAGO**  
 630 W. RANDOLPH STREET CHICAGO 6, ILL.

#### IT'S NEW



#### THE HI-PAR Non-Directional FM Antenna

#### NON-DIRECTIONAL

"You wouldn't buy a radio without a dial and only one push-button, so why limit your FM reception with an ordinary antenna. The HI-PAR non-directional gets them all."

Immediate Delivery Patent Pending

**HI-PAR PRODUCTS CO. FITCHBURG MASSACHUSETTS**



### RCA VICTOR

#### EYE WITNESS TELEVISION RECEIVERS

Flate Face Pictures, 13 Channels.  
 Model 821TS-7" Set.....\$298.80  
 Model 830TS-10" Set.....432.60  
 Model 841TV-10" Console, including Television, Automatic Gramophone, F.M. and A.M. radio...\$88.00  
 Prices above include original RCA factory installation in their service areas as well as guaranty for 12 months on the set and kinescopes. City sales tax where applicable added.

#### LATEST TELEVISION COMPONENTS

Part No.	Price
47204X	RCA FRONT END consisting of a complete television 13 channel tuning assembly including tubes, coils, switch, input converter, IF transformer, and fine tuning capacitors, ready to attach to a suitable IF input.....\$97.50

#### TELEVISION I-F AND VIDEO COIL KIT

47204X1	RCA IF and Video coil kit contains all the necessary IF and video coils for a complete 4 megacycles wide band-pass as well as the sound IF and discriminator transformers for a complete television set.....\$33.00 I.F. Video frequency—25.75 MC I.F. Sound frequency—21.25 MC
47201D1	Deflection YOKE for use with 7DP4, 10DP4, 15DP4 magnetically deflected tubes.....13.75
47201D2	Deflection YOKE for use with 5TP4 projection kinescope.....14.90
47201X1	Yoke mounting hood for above yokes... 2.75
47202D1	Magnetic focusing coil for 5TP4, 10BP4, 15DP4 for use in series with divider... 9.10
48202D1X	Magnetic focusing coil for same as above but 10,000 ohm D.C. resistance... 9.90
47203D1	Ion trap magnet for tubes 7DP4 and 10BP4..... 6.50
47211T1	Horizontal output transformer with 9000 volt kick-back output for 2nd anode... 16.85
47208T8	Horizontal blocking sync. discriminator transformer as used in RCA AFC circ... 4.75
47208TX	Horizontal blocking oscillator transformer UTC high perm. iron. SPECIAL... 2.75
47201R1	Horizontal width control for use with 7DP4, and 10BP4 or 15DP4..... 1.30
47201B1	Spherical mirror for use with 5TP4 in projection systems.....150.00
47201F2	Aspherical correcting lens to use with above mirror..... 50.00
47204T2	Vertical output transformer..... 9.00
47208T2	Vertical blocking oscillator transformer RCA..... 5.70
475218	FRAME with shatterproof glass and rubber mask for use with 12AP4 tube... 8.00
475300	H.V. capacitor, .03 mfd 7500 volt working, grounded negative GE Pyranol... 3.75
475301	H.V. capacitor, .1 mfd 7500 volt working, grounded negative GE Pyranol... 7.50
475302	H.V. capacitor, 2x.1 mfd 7000 volt working, grounded negative GE Pyranol... 9.00
475303	H.V. capacitor, .05 mfd 16000 volt working, grounded negative Sprague... 9.90
475305	TRANSMISSION 7 inch Television Kit, all parts and tubes included.....159.50
475308	Transmission 12" Television Kit.....289.50
473007	Thordarson Transformer, 15000 Volt AC and filament winding as required..... 27.00

#### RCA HIGH FREQUENCY SWITCH AND COIL ASSEMBLY

RF unit, used in TRK12 RCA television receivers consisting of 5 band range switch with shield plate and mounting studs, including 5 polystyrene antenna coils, permeability tuned, each consisting of primary ring, secondary coil and primary mica capacitors. The assembly can be used in TELEVISION, F.M. and other HIGH FREQUENCY APPLICATIONS.  
 CATALOG No. 5210—Special price.....\$5.60

#### RCA VARIABLE TUNING CERAMIC CAPACITOR

To be used in conjunction with the above switch assembly 2-4.5 MMFD.  
 CATALOG No. 5211—Price.....\$2.10

#### GATHODE RAY TUBES

Type	Make	List Price	Your Price
5BP4	DUMONT	\$24.75	\$ 7.95
5BP4	RCA	27.50	7.95
5CP1	PHILLIPS	24.50	7.95
5JP4	DUMONT	90.00	7.95
5TP4	Projection RCA	.....	67.50
7DP4	RCA	.....	14.95
7EP4	DUMONT	.....	23.25
7GP4	RCA	.....	24.25
8AP4	RCA	.....	121.50
10BP4	RCA	.....	49.50
12AP4	RCA	.....	75.00
13AP4	DUMONT	.....	129.50
20BP4	DUMONT	.....	270.00

All tubes are brand new, perfect, in factory sealed cartons, late production.  
 Send 50 cents for complete catalog including diagrams for RCA, G.E., Dumont, Andrea and Viewtone Television Receivers.  
 World's First Specialized House in Television.

**TELETRONICS SERVICE AND SUPPLY CORP.**  
 264 WEST 40TH STREET NEW YORK 18, N. Y.  
 Phone Pennsylvania 6-8730

# Manufacturers' Literature

Readers are asked to write directly to the manufacturer for the literature. By mentioning RADIO NEWS, the issue and page, and enclosing the proper amount, when indicated, delay will be prevented.

#### EXCITER DATA

Columbus Electronics, Inc. have announced the availability of a new bulletin describing their FM Modulator Exciter Model FMO-428.

This unit which has been designed to serve as an e.c.o. exciter for amateur transmitters is featured in the bulletin, and, in addition, details of their high gain 6, 10, and 11 meter frequency converters are given.

A copy of Bulletin RN1 will be supplied by Columbus Electronics, Inc., 229 So. Waverly Street, Yonkers, New York, upon request.

#### CHARACTERISTICS CHART

A two-page chart titled "Basic Characteristics of Useful Industrial Laboratory Instruments" is now being distributed by North American Philips Co., Inc. to engineers, production control personnel, and manufacturers.

The data is presented in a convenient form and the chart may be hung on the wall for ready reference. The chart covers the apparatus or system, principle, basic arrangement, operation, application, comments, and manufacturers or suppliers.

Fifteen instruments are covered in the tabulation including colorimeters, cyclographs, electron microscopes, Geiger-Counter x-ray spectrometers, mass spectrometers, photometers, magnafux, photometers, spectrographs, etc.

Diagrams of the basic arrangement of the instrument being covered are also included.

A copy of the chart may be secured by asking for publication R-1066 from North American Philips Co., Inc., 100 East 42nd Street, New York 17, New York.

#### RADIO AND INSTRUMENT KNOBS

Kurz-Kasch, Inc. has just issued a new catalogue, No. 103A, covering the company's line of standard radio and instrument knobs.

This 12-page booklet carries dimensions and construction details covering instrument knobs, pointer knobs, pointer and lever knobs, control knobs, terminal and control knobs, control balls, radio knobs, pointers, and headless setscrews.

Manufacturers are invited to submit their production requirements to the company. A copy of catalogue No. 103A will be forwarded upon request to Kurz-Kasch, Inc., 1425 South Broadway, Dayton 1, Ohio.

#### AUTO RADIO ACCESSORIES

Servicemen who handle the installation and repair of auto radios will be interested in a new 8-page booklet

just released by J. F. D. Manufacturing Co. of Brooklyn, New York.

Listed in the catalogue are cables, housings, fittings, connectors, radio control shafting, body plugs, wire-wound suppressors, antennas, and miscellaneous auto radio accessories.

Especially featured in this booklet is the company's "Remote-O-Cable Replacer" which is designed to speed auto radio repairs by providing, in a single unit, facilities for cable swedging, cable cutting, and fitting clamping.

A copy of this booklet may be secured from Dept. R, J. F. D. Manufacturing Co., 4117 Ft. Hamilton Parkway, Brooklyn 19, New York.

#### UNIVERSAL PARTS CATALOGUE

A 24-page brochure covering universal electronic parts for distributors and radio servicemen has been announced by the Specialty Division of General Electric Company's Electronics Department.

The catalogue lists the price, specifications, and other data on sixteen parts in the division's line. Resistors, controls, antennas, the variable reluctance pickup, and loudspeakers are among the parts described.

A copy of catalogue ESD-93 may be secured from the company's distributors or by writing, Specialty Division, General Electric Company, Electronics Department, Syracuse, New York.

#### RIDER MASTER INDEX

John F. Rider, Publisher, Inc. has announced the availability of a new master index to the company's "Perpetual Troubleshooter's Manuals."

This "1947 Rider Master Index" covers all editions of the Manuals through Volume XV, which appeared in 1946, and includes the RCA-Cunningham and the Abridged I-V manuals.

The index is bound in paper covers and is in a companion size to the Rider Manuals. The price is \$1.50 and may be obtained from John F. Rider, Publisher, Inc., 404 Fourth Ave., New York 16, New York.

#### GCA BOOKLET

The Bendix Radio Division of Bendix Aviation Corporation has prepared a new non-technical booklet covering a step-by-step explanation of the function of ground controlled approach radar for landing planes safely in foul weather.

This 16-page booklet is well illustrated and the text material is presented with a clarity of style which would make the publication of interest to both laymen and persons working in the radio and radar field.



Copies of the booklet "What is GCA?" may be secured by writing Bendix Radio Division of Bendix Aviation Corporation, Baltimore 4, Maryland. Please address your requests to the attention of Mr. John M. Sitton.

### H.F. CONVERTER BULLETIN

A four-page bulletin covering the line of high frequency converters manufactured by Columbus Electronics Corporation is now available for distribution.

Details and specifications on the company's Model HFC 610 for the 6, 10, and 11 meter bands; the Model HFC 101 for the 10 and 11 meter bands; and the Model HFC 106 for the 6 meter band are given, along with prices.

A copy of Bulletin C6 will be supplied upon request to Columbus Electronics Corporation, 229 So. Waverly Street, Yonkers, New York.

### HYTRON TUBE CATALOGUE

Currently available for distribution, the four-page Hytron Radio and Electronics Corp. catalogue covering transmitting and special purpose tubes contains information of interest to those in the radio industry.

Engineering and operational data is provided in convenient tabular form on low-and medium-mu triodes, high-mu triodes, v.h.f. triodes, v.h.f. miniatures and acorn r.f. pentodes, transmitting beam pentodes and pentodes, rectifiers, and voltage regulators. Basing diagrams for the tubes are also given.

A copy of this catalogue will be sent to those requesting it from Hytron Radio and Electronics Corp., 76 Lafayette Street, Salem, Massachusetts.

### SERVICE DATA CHART

Sprague Products Company of North Adams, Massachusetts is now offering radio servicemen a giant wall chart for use in service shops.

Lithographed in color, this 22" x 28" chart carries handy service application data; diagrams and descriptions of common circuit troubles involving condensers and their remedies; general replacement data on electrolytics; formulas; transformer, resistor and condenser color codes; schematic symbols and other related information.

The wall charts are being distributed by Sprague distributors throughout the country and servicemen can obtain free copies from them on request.

### HARDWARE CATALOGUE

The new two-color, 8-page hardware catalogue which is now being distributed by General Cement Mfg. Co. of Rockford, Illinois features a new patented "4 in 1" card which enables jobbers to display four items in the space normally required to display one item of merchandise.

The catalogue lists items by classification groups and almost 500 items have been included.

Copies of this catalogue are free

September, 1947

## IT'S NEWARK FOR TOP QUALITY - BEST VALUE

**Sensational Buy!**  
**HALLICRAFTERS PANORAMIC ADAPTOR SP-44**  
 Really Terrific! The famous Sky Rider, sold everywhere for \$99.50, now reduced at Newark to only \$49.50. "Seeing Eye of Sending" is a 10 Tube Superhet, electronically-tuned, with self-contained scope—monitors up to 200 kc visually and analyzes signal kc characteristics from your own or other transmitters. Hooks into any rig. No Ham should be without one.  
 SP-44—Complete with tubes, for 115 VAC. Shpg. Wgt., 20 lbs. NOW...  
**\$49.50**

**While They Last!**  
**NEWARK CRYSTALS**  
 6-11-20-40-80 Meters  
 Terrific Values! What's left of our famous, accurately calibrated 88c Crystals at this unbelievable price!  
 Orders filled to within 25 KC of desired frequency in the following groups only. Hurry!  
**49¢ EA.** \$ for \$1.25  
 A-3800-3956 D-8701-8890  
 B-6250-6995 E-9000-9250  
 C-7200-7265 F-14065-14220

**SCR-522 TRANSCIEVER**  
  
 Terrific Value! Famous Surplus Receiver-Xmitter. Less Power Supply and Control Box. Some have Crystals and Tubes, some may be missing. But the basic unit is ready to operate. Can be converted to 110 VAC. Schematic incl. Shpg. Wgt. 75 lbs. Limited Quantity. "AS IS" for...  
**\$14.95**  
 FOB New York Only

**New Types - Bigger Values**  
**Transmitting and Special Purpose TUBES**  
 ALL NEW - GUARANTEED, Great Savings from our Tremendous Stock of Top Grade Gov't. Surplus Tubes. All JAN Approved. Buy Now!

E1148	\$ 2.25	811	\$1.95
HY65	3.00	813	6.75
HY69	1.65	814	4.50
HY615	1.13	815	2.25
TZ40	1.88	826	1.50
2AP1	2.25	832A/832	2.25
2AP1A	5.25	836	1.13
2C26A	.75	837	2.25
2C40	.90	838	3.75
2C44	1.50	841	1.20
2Y3G	1.38	843	.75
2X2/879	.90	845W	3.75
3AP1	3.00	865	1.50
3BP1	3.00	872A/872	2.25
3C24/24G	.75	874	1.95
3CP1	3.00	884	.75
3EP1	3.00	922	.68
3E29	3.00	923	.45
3P7	3.00	931A	1.80
3GP1	3.00	954	.75
5AP1	4.50	955	.75
5BP1	3.38	956	.75
5BP4	3.38	957	.75
5CP1	3.38	958A	.75
5CP1A	6.00	959	.75
5LP1	9.00	1617	.75
6AK5	.90	1616	3.00
6D4	.45	1619	.75
7BP7	5.25	1624	.90
9JP1	2.25	1625	.53
10Y	.75	1626	.60
12DP7	6.00	1629	.27
12GP7	11.25	1641	.90
OC3/VR105	.75	1665/2050	.95
OD3/VR150	1.13	2051	.33
211	3.75	7193	.45
304TL	.75	8005	3.15
316A	1.13	9001	1.05
559	1.13	9002	.90
801A/801	9.00	9003	1.05
803	.95	9004	.90
807	1.50	9006	.68

**MALLORY VIBRPACK**  
  
 Vibrator Power Supply. Efficient, Dependable. 12 volt DC Input. Output: 220-250 volts at 60 ma. Exceptional Buy! Size: 5 1/2 x 2 1/2 x 6" H. No. S-460. Special...  
**\$6.95**

**ARMY NAVY PHONES**  
 - Great Buy -  
  
 Brand New, Guaranteed Army-Navy Phones. 8000 ohms. Rubber covered throughout. Ear Cushions, Cord, PL-54 Plug. Adj. band. No. S-481. Hurry!  
**99¢**

**Cornell-Dubilier Xmitting Capacitor**  
**2 Mfd - 1,000VDC**  
 New, oil-filled, Exceptional Quality 4 1/2" L. x 1 1/2" dia. No. S-473. Special...  
**49¢**

**BUY OVER \$75 WORTH OF EQUIPMENT Take ONE YEAR to PAY 20% Down—Pay Monthly**

**NEW YORK** Offices & Warehouse 242 W. 55th St., N.Y. 19

**NEWARK** ELECTRIC COMPANY, INC.

**CHICAGO** 323 W. Madison St. Chicago 6, Ill.

New York City Stores: 115-17 W. 45th St. & 212 Fulton St.

**NOW Economically**  
**FOR YOUR SILENT PROJECTOR**  
**\$59.95**  
 Convert your 16mm silent projector to sound (regardless of make) with Apex sound head & radiofilm adapter. Guaranteed excellent performance. Write today for free information.  
 APEX VIDED • 12200 J Branford St. • Roscoe, Calif.

**BEAM ROTATORS**  
 Plenty husky for any beam a ham can dream up! Navy SO-1 radar type. Beautifully built mechanically and electrically. Instantaneously reversing. No overswing. Brand new complete with 110 volt 60 cycle power supply. Write for details. f.o.b. Tuckahoe, N. Y.  
**\$89.00**

**TELEVISION RECEIVER—\$1.00**  
 Complete instructions for building your own television receiver. 16 pages—11" x 17" of pictures, pictorial diagrams, clarified schematics. 17" x 22" complete schematic diagram & chassis layout. Also booklet of alignment instructions, voltage & resistance tables and trouble-shooting hints.—All for \$1.00.  
 CERTIFIED TELEVISION LABORATORIES  
 5507-13th Ave., Brooklyn 19, N. Y.

**1 K.W. MOTOR GENERATORS**  
 Ideal for D.C. power district use, marine radio, or radar, etc. 115 volts D.C. input at 14 amps. 120 volts A.C. output at 10.4 amps. 60 cycles single phase. 1000 watts continuous duty. 3600 rpm. Centrifugal starter. Fully covered splashproof. Built to Navy specifications by the Allis Chalmers Co. Brand new. f.o.b. Tuckahoe, N. Y.  
 230 volt input machines, same specifications also available. Price... f.o.b. Tuckahoe, N. Y.  
**\$125.00**  
**ELECTRONICRAFT, Inc.**  
 Tuckahoe 3-C-04 • 5 Waverly Place • Tuckahoe, N. Y.

# BUILD YOUR OWN

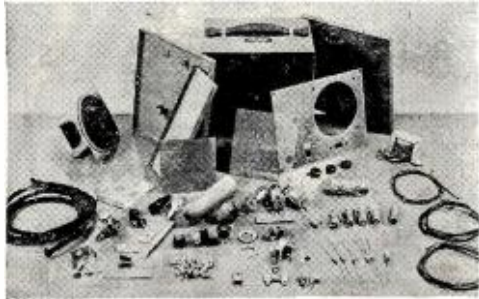

## Signal Tracer

Complete Kit of  
High Quality Parts.  
Detailed Instructions.  
Operation Handbook.  
**\$17.95** Complete

Here's a fine professional test instrument you can assemble for yourself! It's a battery operated signal tracer you can use anywhere. All components are of same high quality used in the finished units which are in use by thousands of service men throughout the country. Parts are packaged and labeled. The assembly instructions are complete. Operation of the finished unit is excellent. If your local parts jobber does not have this STAB-KIT in stock write us. If you'd rather have a finished instrument they are available at \$29.95. AC operated kits also available at \$29.95 or

completed AC instruments at \$44.95. You'll not only be proud to own one of these fine instruments but it will make real money for you by speeding up your service work. Order your kit today.

### NEW! SPECOCOILS

For you who want to build FM tuners or Television sets SPECOCOIL IF transformers enable miniaturization with correct band pass characteristics. Small, tuned from top, short leads to related components. New electronic principle. Circuit supplied free. Ask your jobber or write for catalog. List \$5.95 each.

**speco**

**SPECIAL PRODUCTS COMPANY**  
9115 Brookville Road, Silver Spring, Md.

# MAGNETIC RECORDERS



**MODEL BK-401 SOUNDMIRROR\***  
\*Trade Mark Reg. U.S. Pat. Off.

THIS TAPE RECORDER-REPRODUCER is a completely self contained unit, having its own amplifier, speaker, and crystal microphone. One half-hour recording time on reel of magnetic tape which is erasable, reusable, and spliceable. For 110 v.-60 cycle. Price ..... \$229.50

BK-914-1 Recording tape on reel, for Soundmirror ..... \$ 2.50

MODEL BK-501 Mail-A-Voice\* \$59.00

With self contained mike, amplifier, and carrying case. Ready to record and playback. For 110 v.-60 cycles. Prices F.O.B. Cleveland; 25% Deposit on C.O.D. orders.

WRITE FOR OUR FREE CATALOG  
Of Magnetic Recorders and Accessories  
**ACME ELECTRONICS CO.**

6523 Euclid Ave. Cleveland 3, Ohio

# WAR SURPLUS!

All merchandise is the product of nationally known manufacturers under government contract—no "off" brands. This merchandise is all BRAND NEW, UNUSED!

- Oscilloscope, BC-1268, 5" C-R tube, contains 24 octal tubes, \$27.50
- Frequency Meter, 70-150 mc, battery operated, with calibration ..... \$17.50
- .1 mfd, 200 vdc paper condenser, Micamold 345-21 ..... 5c
- In lots of 50, each ..... 4c
- .5 mfd, 200 vdc paper condenser, Micamold. In lots of 50, each ..... 6c
- 4 mfd, 500 vdc, paper condenser, excellent for replacing electrolytic filters, will give superior service ..... 58c
- 8 mfd, 450 vdc, electrolytic, popular inverted cap, nut mounting, Cornell Dubilier KR-508 ..... 32c
- Antenna, MN-56, 3/4" dia. x 37 1/2" long copper plated steel tubing with mounting bushing. Suitable for dipoles, verticals, whips, beam elements, etc. Easily cut to length ..... 19c
- Microphone, T-24, carbon, hand type, American Microphone Co., for mobile rigs, etc. \$1.95
- 0-1 ma DC Meter, 3/4" round, Weston 301... \$4.25
- Pilot Lamp, 1" dia. Jewel, enclosed type, for S-6, 115v bulb, Dialco No. 9387, any color Jewel. (Specify) ..... 43c
- Pilot Lamp, jeweled enclosed type, for bayonet base bulb, any color Jewel. (Specify color), 10-10-10 mfd, 4 sect, electrolytic, all 400 vdc, Mallory FP can type ..... 79c
- Volume Control-Pot, 60,000 ohms, Clarostat... 29c
- Speakers, large variety at low prices. Write for details.
- Tubes large stock receiving, Xmitting, Cathode-ray, etc.
- Formers, power, audio, chokes, etc. Write for details.

## Price RADIO Laboratories

2816 Hemlock Ave., Baltimore 14, Md.

F.O.B. our warehouse. Minimum order \$2.00. We also ship C.O.D., 10% with order.

for the asking. Address requests to General Cement Mfg. Co., 919 Taylor Ave., Rockford, Illinois or see your GC distributor.

### LIMITING AMPLIFIER

The Transmitter Division of General Electric Company's Electronics Department has prepared a new 12-page booklet describing the company's Type BA-5-A limiting amplifier.

The new publication, complete with schematic drawings and diagrams, lists the operational and constructional features of the amplifier, a unit designed to increase the average program level of broadcasting and recording systems without danger of any audio peak exceeding a predetermined maximum value.

A copy of this booklet, EBR-99, will be forwarded to those making their request of the General Electric Company, Transmitter Division, Electronics Park, Syracuse, New York.

### ENGINEERING DATA BOOK

The Superior Electric Company of Bristol, Connecticut is now releasing a 12-page bulletin on voltage control which will be of interest to designers and engineers.

Bulletin #547 features the latest developments in "Powerstat" variable transformers and "Stabiline" automatic voltage regulators. The material is presented in concise and easy-to-read form, Ratings, detail drawings, photographs, performance, and engineering data are included in the bulletin.

Copies of Bulletin #547 may be secured by writing The Superior Electric Company, 211 Church Street, Bristol, Connecticut.

-30-

### Within the Industry

(Continued from page 30)

ments, and other factors pointing the way to greater efficiency, increased production, lower cost, and improved service in the induction and dielectric heating field.

**ELECTROVOX CO., INC.** has recently acquired a new and larger plant at 66 Franklin Street, East Orange, New Jersey.

General offices of the company will continue to be located at 31 Fulton Street, Newark, New Jersey until next year, at which time the offices will occupy space in the new building.

Branch offices in Chicago and Los Angeles will continue at their present locations.

**ELECTRONIC LABORATORIES, INC.** has recently acquired a plant in Harbor Springs, Michigan, for the manufacture of wood cabinets for the company's line of home receivers.

Logs are being cut on a 2000 acre property with all steps in the manufacture of these cabinets, from the felling of the timber to cabinet finish-

**RADIO NEWS**

ing, being performed by the Wood Products Division of the company.

**P. R. MALLORY & CO., INC.** has announced the removal of their New York Office to 41 East 42nd Street, Suite 1215.

The company, manufacturers of electrical and electronic components, has headquarters and main plants in Indianapolis, Indiana and branch plants in North Tarrytown, New York and Tipton, Indiana.

**JAMES R. DONAHUE** was elected President of *Arcturus Radio & Television Corporation*, a newly formed associate company of *Standard Arcturus Corporation of New Jersey*.



This new associate company will manufacture television receivers in the popularly priced field. Mr. Donahue, who has spent his entire business career in the radio and electronic field, was formerly Sales Manager of the parent company.

Announcement was also made of the appointment of John V. Rice, formerly associated with *National Union Radio Corporation*, to serve as Sales Manager of the Tube Division of *Standard Arcturus*.

**MELVILLE RADIO INSTITUTE** has recently moved to new offices in the Melville Building, 15 West 46th Street, New York.

The Institute was formerly housed in quarters at 45 West 45th Street but the necessity for increased office space dictated the move to the new location.

**AIR KING PRODUCTS COMPANY** has recently acquired an additional plant at 170 53rd Street, Brooklyn, New York, for the straight line manufacture of radio receivers.

The new plant has 110,000 square feet of space and occupies a whole city block. The unit is air conditioned and lighted with fluorescent fixtures throughout. Belt gravity conveyors will be used to speed the larger components to the production line.

In addition to production facilities, the building contains offices, showrooms, and conference rooms.

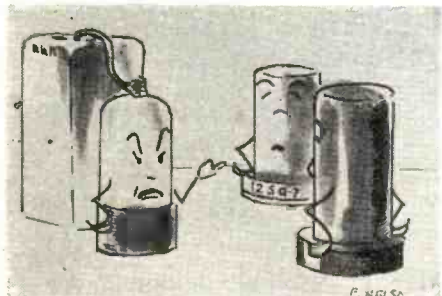

"Boy! Has he gone High Hat, since that last serviceman called him a Duo-Diode, High-Mu Triode!"

September, 1947

**your basic 3R's for correct current control**

**Ward Leonard RELAYS**

**Ward Leonard RESISTORS**

**Ward Leonard RHEOSTATS**



**RELAYS**—provide convenient circuit control, protection, and greater operating efficiency . . . help reduce length of connecting leads. Amateur Relays available from stock: Antenna Change-Over, Antenna Grounding, Keying, Band Switching, RF Break-In, Safety, Overload, Underload, Latch-In, Remote Control, Sensitive, Time Delay. Also Industrial and General-Purpose Relays.

**RESISTORS**—exclusive features of VITROHM wire-wound resistors insure that extra performance needed in critical circuits. Fixed type in 8 stock sizes from 5 to 200 watts. Adjustable type in 7 stock sizes from 10 to 200 watts. Wide range of resistance values. Stripohm, Discohm, and Plaque types also available.

**RHEOSTATS**—for fixed or variable close control. Protected by tough, acid resistant, crazeless vitreous enamel. Sizes: 25, 50, 100, and 150 watts, in wide range of resistances.

Authorized Distributors Everywhere  
**WARD LEONARD ELECTRIC COMPANY**  
 Radio and Electronic Distributor Division  
 53-N West Jackson Blvd., Chicago 4, U. S. A.



**SEND FOR FREE CATALOGS**  
 Write for Amateur Relay Catalog No. D-111, and for Resistor-Rheostat Catalog No. D-2.

**WARD LEONARD**  
**RELAYS • RESISTORS • RHEOSTATS**  
 Electric control devices since 1892

**LEARN TELEVISION ELECTRONICS RADIO**

Modern Completely Equipped Laboratories

DAY AND EVENING CLASSES  
 G.I. Approved—Veterans Receive Subsistence

ENROLL NOW!  
**ELECTRONICS INSTITUTE, INC.**  
 21 Henry, Detroit 1, Mich.

Special To **SERVICE DEALERS**

**4** **JOB CARDS** also 4-in-1

with **COLOR OVERLAY**

BUSINESS CARDS  
 STATEMENTS  
 NOTE HEADS  
 ENVELOPES

IN MATCHING ELECTRONIC DESIGN

SAMPLES ON REQUEST **RADIO PRESS** MORGANTOWN WEST VIRGINIA

# "TELEVISION SPECIALISTS"

## Design Data & Parts

• **NEW TELEVISION COIL KIT 510**—Build a 10" or 15" television receiver. • Complete kit of permeability tuned video IF, RF, and Sound Coils for high quality television receiver designs. Contains all necessary coils for 3 stages 4mc. wide video, 2 stages sound, discriminator, peaking, oscillator, and RF. Complete instructions included. Priced at Only.....\$9.95

**TELEVISION COIL KIT 500A**—Including 10 matched coils for low cost 7" television receiver design described in booklet. Only.....\$4.95

### "Design and Construction of a Modern 5 or 7" Television Receiver"

New 2nd Edition

More Pages, Greater Detail, Drawings, Photographs, Designed for Good Performance, Simplicity, Economy, For Experimenters, Servicemen... any technicians that prefer to build their own.

### "Design and Construction of a Visual Alignment Sweep Signal Generator"

Build a Television Sweep Generator, inexpensive, simple... yet professional in performance. A "must" for servicemen... for alignment of Television Receivers.

Included with each booklet is an 11 x 17" working diagram.

### We Carry a Complete Line of Television Parts for the Experimenter!

R.F. & I.F. Coils C.R. Tubes  
H.V. & L.V. Transformers Punched Chassis  
Complete line of Resistors, Condensers, Special CR Tube Sockets, etc.

SEND FOR OUR LATEST PARTS LIST



P. O. Box No. 52, Kew Gardens 15, N. Y.

- Enclosed is \$\_\_\_\_\_ (check or money order).  
Quantity \_\_\_\_\_
- \_\_\_\_\_ Television Receiver Bklet.....\$1.75 ea.
  - \_\_\_\_\_ Sweep Signal Generator Bklet....\$1.75 ea.
  - \_\_\_\_\_ Television Receiver Coil Kit 500A.\$4.95 ea.
  - \_\_\_\_\_ Permeability Tuned Coil Kit 510..\$9.95 ea.

Name \_\_\_\_\_  
Address \_\_\_\_\_  
City \_\_\_\_\_ Zone \_\_\_\_\_ State \_\_\_\_\_  
Order Direct or Through Your Dealer

**CORRESPONDENCE COURSES IN RADIO and ELECTRICAL ENGINEERING**

**ELECTRICAL ENGINEERING** Get good grasp of wide electrical field. Prepare yourself at Low Cost, for secure future. Modern course. So simplified anyone can understand quickly.

**RADIO ENGINEERING** Extra fine course in radio public address, photo-electric work. Trains you to be super-service man, real vacuum-tube technician. Serviceman needed badly. Diploma on completion. Many graduates earning big pay.

**WRITE** Send postcard for Free Copies of \$25 Either School catalog, full details, all 45 Courses about deferred payment plan, experimental kits, etc. Lincoln Engineering School, Box 931-R104, Lincoln 2, Neb.

**SERVICEMAN SPECIALS**

- 2-inch PM speaker ..... \$1.19
- 3-inch PM ..... 1.39
- 4-inch PM—Ainico 5 ..... 1.39
- 5-inch PM—1 oz. Ainico 5 ..... 1.49
- 6-inch PM—1½ oz. Ainico 5 ..... 1.79

**2-TUBE AC-DC PHONO OSCILLATOR KIT**  
Complete with tubes, parts, and full instructions. \$4.49

ABOVE KIT ASSEMBLED AND TESTED ..... \$5.59  
EXPERIMENTAL COIL ASSORTMENT ..... 1.25

**REMER RADIO**  
5904 S. Princeton Chicago 21, Ill.

## LOW-IMPEDANCE LOOPS

By HARRY R. HYDER

**M**OST broadcast sets use loops of the "high impedance" type; that is, a loop which contains all of the antenna inductance. While loops of this type are economical and adequate for small sets, they have some disadvantages. First, since the loop has a high Q, slight changes in its position relative to the chassis or other metallic objects make large changes in its inductance, making good tracking difficult to maintain. Thus, placing a loop set next to a radiator might upset its tracking seriously. Also, the high voltage across the loop, which is in close proximity to the set, causes undesirable coupling to other parts of the set, resulting in regeneration and instability. This is why some sets have an aluminum baffle between the loop and the chassis.

A much better scheme, particularly for a console set, is to use a "low impedance" loop. This is a loop of large physical dimensions but which has very low inductance, usually about 10 microhenries, or 5% of the required antenna inductance. Since it is but a small fraction of the antenna inductance, capacitance and inductance variations will have little effect on the tuned antenna circuit as a whole. Also, since the voltage across it is low, coupling to other parts of the circuit will be low. There are two methods of coupling the low-impedance loop to the grid of the first stage. The first method is to use a low-impedance, primary-tuned secondary r.f. transformer; but this is a special coil and they are not currently available. A far simpler scheme, which is just as effective, is to place a loading coil in series with the loop (Fig. 1) and feed it directly to the grid of the tube. The only requirement of the loading coil is that it have enough inductance to make up the difference between the required inductance and the inductance of the loop, and have a reasonable Q. One can be made from a standard "Universal Adjustable" replacement antenna coil. These have iron slugs, permitting the inductance to be varied over a range of about 20%. Several standard types were measured and found to average about 125 in Q. The best one had a progressive-universal

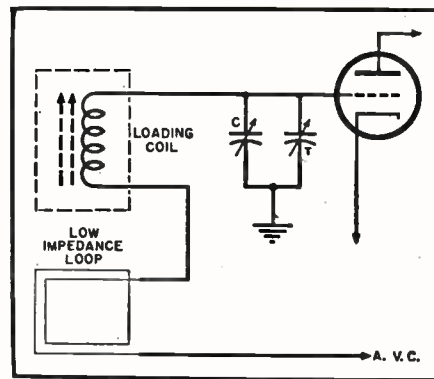

Fig. 1

wound Litz wire secondary and had a Q of 150 at 1 mc. The primary was removed from the form and it was wired as shown in the diagram. The slug makes adjustment of inductance for tracking very simple and precise. This is the procedure; with the loop and loading coil wired as shown, tune in a weak station near 600 kc. and adjust the slug for maximum volume. Then tune in a weak signal near 1400 kc. and adjust the antenna trimmer on the tuning condenser for maximum volume. Repeat these two adjustments in the same order, and the set is "tracked." The weaker the signals used, the more accurate will be the adjustments.

In actual measurements on one set, the sensitivity with the low-impedance loop was greater than with a high-impedance loop having an operating Q of 100. In addition, noise, instability, and lopsided selectivity, all due to regeneration, were completely eliminated. Also, the tracking "stayed put."

The loading coil was mounted in its shield can on the chassis. The low impedance loop consisted of 2 turns of No. 16 hook-up wire, spaced 2 inches between turns and stapled to the inside of the console. Its exact dimensions are unimportant, but it should have as large an area as possible, for maximum signal pickup.

—30—

### The 829-B and 832-A

(Continued from page 60)

former. Column 3 are the values obtained by using an 832-A tube in place of the 829-B.

Because of the results obtained in

the experiment, it is believed that many amateurs will find uses for these two tubes in audio amplifiers. A very compact transmitter could be built by using an 829-B in the final r.f. amplifier with 90 watts input and modulating it with another 829-B with 500 volts on the plate.

—30—

Table 1. Operating characteristics of the 829-B and 832-A tubes at audio frequencies.

	829-B	829-B	832-A
Plate Volts.....	500 volts	315 volts	315 volts
Screen Volts.....	225 volts	225 volts	250 volts
Plate Current.....	200 ma.	150 ma.	108 ma.
Screen Current.....	25 ma.	26 ma.	12 ma.
Cathode Voltage.....	19.5 volts	16 volts	20 volts
Cathode Resistor.....	100 ohms	100 ohms	200 ohms
Undistorted Output.....	43 watts	20 watts	10 watts
A.F. Voltage for Undistorted Output.....	16 volts	10 volts	16 volts
Maximum Output.....	65 watts	29 watts	18.5 watts
A.F. Voltage for Maximum Output.....	22 volts	16 volts	25 volts
Plate Impedance.....	10,000 ohms plate-to-plate in all cases.		

# Technical BOOKS

**"THE FUTURE OF TELEVISION"**  
by Orrin E. Dunlap, Jr. Published by Harper & Brothers, New York. 190 pages. Price \$3.00.

When the author published his "The Outlook for Television" in 1932, the book covered past developments in the television field. This companion book, while outlining some of the great achievements in the field, goes beyond the present for a good look at the future of the medium.

In spite of the nebulosness of the future of television, this book is definitely not in the "crystal ball" category. The author, who is on the executive staff of *Radio Corporation of America* and was, for almost twenty years, radio editor of *The New York Times*, is in a strategic position which allows him to survey both the pros and cons, the acceptance or non-acceptance of the public, competition with movies and other entertainment media, and the type of programming concept which will provide commercialization of television.

While the book takes the technical side of television performance for granted, the author has raised many pertinent and important problems which the prospective station owner, program director, staff, and the public must take into consideration in the production and reception of this medium.

A valuable appendix which lists important dates in the development of television and video programming, and a list of American television stations, by channel, complete this projection into the future of the video art.

**"TELEVISION TECHNIQUES"** by Hoyland Bettinger. Published by Harper & Brothers, New York. 229 pages. Price \$5.00.

Since many of the new television stations being constructed in the country will demand complete versatility of its employees, this book on television techniques should find wide acceptance among those involved with the technical aspects of the transmission as well as those whose work deals with the programming and planning of video entertainment.

The author, who is a consultant on television programming and production, was formerly Program Manager of the *General Electric* station, WRGB, in which position he had wide experience with the various experimental video techniques. This book, based on the author's knowledge of the problems confronting a TV station staff, is a completely practical handbook.

The text material has been lavishly illustrated and the reader should experience no difficulty in visualizing the problem and its solution. The author has covered television equipment in a

September, 1947

## PEERLESS PACKS Value PUNCH



### APPROVED FM TUNER

RESONANT LINES TUNED FRONT END\*  
• NO VARIABLE • NO IRON CORE SLUGS • NO SLIDES • STABLE • NON-MICROPHONIC

The outstanding FM Tuner of the year at a fabulously low price. The Approved is a high quality, superb tuner with 8 tubes: 6AG5 R.F. Amplifier; 6J6 Oscillator, Mixer, Detector; 2-6SH7 I.F. Amplifiers; 6SN7 Limiter; 6AL5 Discriminator; 7Y4 Rectifier; 6U5 Indicator (Tuning Eye).

For 88-108 mc. reception, with intermediate frequency of 10.7 mc. (iron core tuned, ceramic insulation). The bandwidth is 150 kc.

Output impedance is 500,000 ohms and the Output voltage is app. 2 volts. Sensitivity is 10 microvolts and hum level is 70 db. below average output. Tuning ratio: 16 to 1. Has tuning control and volume control with "on/off" switch.

Quality materials are used throughout, such as phosphor bronze contact springs and tuned brass lines, both with .0005 inch silver overlay. Contact arms are lucite bars. For 117 volt, 60 cycle operation.

Complete with tubes and built-in power supply.

\* Pats. Pend.

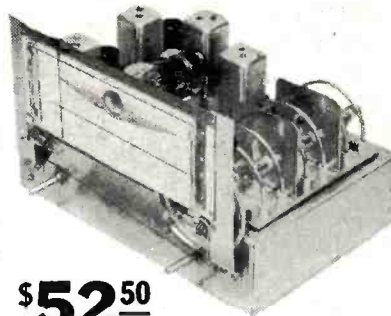

**\$52.50**  
NET  
Less Cabinet

PEERLESS—LOW PRICE

**MATCHING CABINET**  
Hand-rubbed walnut veneer... **\$6.95**

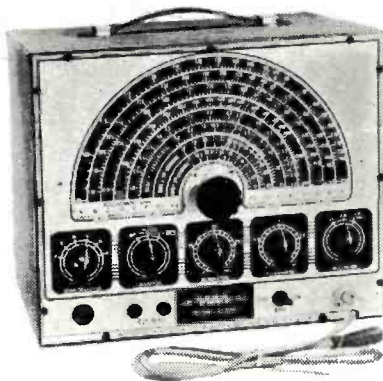

### APPROVED SIGNAL GENERATOR

Compare this superior signal generator with any on the market today at any price. Convince yourself that the Approved is tops! Look at these outstanding features:

The Approved gives you complete coverage in 8 bands from 100 kc. to 75 mcs. There is a large calibrated face with a multicolor, no-glare frequency dial. Four tubes: 6SN7 RF Oscillator; 6SH7 AF Oscillator and Modulator; 6SH7 Cathode Follower Output Stage; 6X5 Rectifier.

There is a 3-step RF Attenuator, but RF-AM attenuation is continuously variable. Because of the cathode follower tube, however, attenuator settings have no effect on frequency. Harmonic output is negligible. The RF Oscillator is ultra stable and has two terminals. Internal or External modulation percentage is continuously variable and ranges from 0 to 100%.

Only silver ceramic and air trimmers are used and the Variable Condenser is Hammarlund's special low drift "invar metal," with ceramic insulation throughout.

There is a pilot light indicator. Set is designed for 105 to 120 volt, 50-60 cycle operation. Comes enclosed in heavy 16-gauge steel cabinet with battleship grey, crackle finish. Includes Amphenol Co-axial connecting cable, ground cable, operating instructions, circuit diagram and guarantee. Size: 8" x 10" x 12". Net wt. 16½ lbs.

**\$39.50**  
NET

PEERLESS—LOW PRICE

### NEW!!! APPROVED RADIATION LOOP AND ALIGNMENT WAND

Provides loose coupling between any generator and receiver. Checks loop-oscillator tracking, increases efficiency of receivers, helps to eliminate squeals due to misalignment or mistracking and enables the service engineer to make gain measurements.

**\$9.95**  
NET

All prices F.O.B. Jamaica, New York. Include postage. Write Dept. RN3.



**RADIO DISTRIBUTORS, INC.**

92-32 Merrick Rd., Jamaica 3, New York

Branch: 71 Murray St., New York 7, N.Y.

## GET THIS NEW RADIO RULE

NEEDED BY ALL RADIO STUDENTS, ENGINEERS, DRAFTSMEN, TECHNICIANS, HAMS

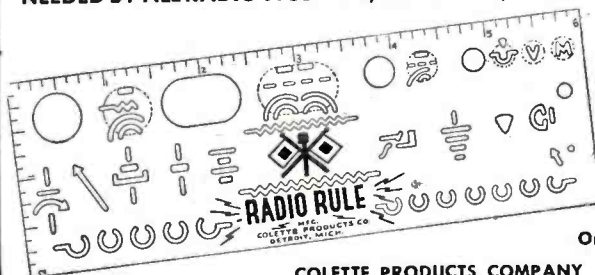

This sensational new Radio Rule was developed by a Radio Engineer for simpler, more accurate work. It has proven so successful that it is now "a necessity" in many schools and universities in the United States.

Made from clear, laminated plastic. Money back guarantee

ORDER TODAY

Only \$2.00 Postpaid or 3 for \$5.00

COLETTE PRODUCTS COMPANY

8653 GRAND RIVER

DETROIT 4, MICHIGAN

**FREE BOOK**  
SHOWS  
**SHORT CUT**  
TO  
**CODE SPEED**

ENDORSED  
BY CHAMPIONS

or Amateur  
of  
Commercial  
Radio

Qualify at home, in spare time, by easy, simplified system. You can learn code or gain greater speed and skill in sending and receiving by the same system that has made code champions and radio telegraph experts. FREE BOOK OF FACTS explains Course. It's absolutely free. Rush your name for it today.

**CANDLER SYSTEM CO.**  
Dept. 2-K, P. O. Box 928 Denver, Colo.

# PICK YOUR SPOTS!



*... Your PR Jobber has them in Stock*

Move on spot frequencies with PR Precision CRYSTALS. PR has made it easy to select the spots you want—for all bands. This summer hundreds of PR Jobbers were supplied with new VISUAL DISPLAY CASES, stocked with all frequencies available to amateurs ... and kept up to date! This means you can walk into your favorite jobber's store and get PRs for the EXACT FREQUENCIES (INTEGRAL KILOCYCLE) YOU WANT WITHIN AMATEUR BANDS AT NO EXTRA COST ... NO PREMIUM ... NO "PLUS OR MINUS" THE SPOT YOU WANT. If you buy your radio gear at a distance ... your jobber can supply PRs at exact frequencies by return mail. Get set ... go PR and KNOW WHERE YOU ARE! — Petersen Radio Company, Inc., 2800 W. Broadway, Council Bluffs, Iowa. (Telephone 2760)

10 Meters—PR Type Z-5 ..... \$5.00  
20 Meters—PR Type Z-3 ..... 3.50  
40 and 80 Meters—PR Type Z-2 ..... 2.85



non-technical manner, explained some of the problems inherent in the medium, and then discussed pictorial composition and continuity, video techniques, audio techniques, television writing, directing and producing, the production of a play, motion pictures and film integration, and finally, television lighting.

For those looking forward to a career in telecasting, this book should provide a thorough and complete understanding of the techniques involved in producing a "bang-up" show.

"TELEVISION," (Volumes III and IV) edited by A. N. Goldsmith, A. F. Van Dyck, R. S. Burnap, E. T. Dickey and G. M. K. Baker. Published by Radio Corporation of America. Price \$2.50 each. Paper edition, \$1.50 each.

These two volumes, the first to appear since the war, cover television advancements in the period 1938-1941 (Volume III) and 1942-1946 (Volume IV). These books are a compilation of technical papers written by RCA staff members on television and associated equipment and techniques.

Volume III is divided into three main sections covering pickup, transmission, reception, general topics, and summaries of articles of interest. Volume IV covers pickup, transmission, reception, color television, military television, general topics, and summaries of articles dealing with special phases of television.

The material, in general, is technical in nature and should be of particular interest to engineers working in the field. Problems involved in television sound transmission, transient response, light valves, projection optics, wide-band amplifiers, local oscillator radiations, etc., are discussed at some length. Mathematics are used freely throughout the text providing a solid technical background for the solution of the problems under discussion.

Representing as they do, the combined efforts of RCA's technical staff, these books should find wide acceptance among television engineers and those concerned with the commercial transmission of video signals.



# AMSCO SPECIAL

## SERVICE KIT

Kit includes assortment of:

100 Resistors, 1/2 and 1-watt.	Wire Wound Resistors—10 & 25 watt.
50 Condensers, paper, mica, electrolytic & can.	25 Connectors, Plugs, Ties.
10 Switches, Toggle, Gang & Rotary.	10 Jacks (Phone) & Tip.
100 ft. Spaghetti, various sizes.	12 Padder Condensers.
12 Knobs, round and bar.	12 Terminal Boards.
2 lbs. Hookup wire.	25 Ceramic Insulators.
20 Fuses.	2 Panel Lights (1 neon).
6 Volume Controls.	1 Screw Driver.
10 Tube Sockets.	1 Tube Puller.
1 lb. Hardware (screws, nuts, lugs, etc.).	2 Allen Wrenches.
	2 Panel Fuse Holders.
	4 Binding Post Strips.
	and many other valuable items.

Your Cost **\$9.95** Complete

FREE—"Experimenter's Kit" "1 Pr. Headphones" or "Lip Mike" with first 500 orders.

Write for our catalog.

**AMERICAN SALES CO.**

1811 W. 47th St.

Chicago 9, Ill.



## TELEVISION MAGNETIC DEFLECTION YOKES

Cat. No. DY-1S:—For 55" tubes such as 10BP4, etc. Horiz. Inductance—5 mh. Vert. Ind.—19 mh. .... **\$9.60**

Cat. No. DY-5S:—Identical to DY-1S except Horiz. Ind.—8 mh. Vert. Ind.—50 mh. **\$9.60**

Cat. No. DY-2L:—For 40" tubes such as 12AP4, 5TP4, etc. Horiz. Ind.—5 mh. Vert. Ind.—22 mh. .... **\$10.50**

A complete line of TELETRON Yoke Matching Transformers, Focus Coils, and Blocking Oscillator Transformers also available.

Write for latest catalog. The TELETRON line now available at many leading jobbers.

**THE TELETRON CO.**  
1988 East 59th Street  
CLEVELAND 3, OHIO

## RELIANCE SPECIALS

Selsyn differential motors, 115V. A.C., 60 cycle ..... **\$1.75**  
Dynamotor, input 27V @ 1.4 A; output 255V @ .06 A ..... **1.35**  
Assorted iron core slugs ..... 23 for **1.00**  
Bathtub condenser, .25 mfd, 400V ..... **8c**

### ELECTROLYTIC CONDENSERS

75 mfd., 25V	15c	1000 mfd., 15V	35c
50 mfd., 50V	10c	1000 mfd., 25V	40c
40 mfd., 25V	10c	225 mfd., 15V	10c
20 mfd., 200V	15c	100 mfd., 150V	20c
10 mfd., 100V	10c	90 mfd., 450V	\$1.40

### CERAMIC CONDENSERS

All 500 Volts

3.44 mmf	56 mmf	82 mmf	<b>6c each</b>
4.7 mmf	62 mmf	150 mmf	
50.0 mmf	68 mmf	220 mmf	

F.O.B. Philadelphia, Pa. Minimum Order \$3.00  
**RELIANCE MERCHANDISING CO.**  
23rd and Arch Sts., Philadelphia 3, Pa.

## PRACTICAL TECHNICAL TRAINING FOR YOU

Specialize in Electronics, Radio, Electricity, Refrigeration, Heating and Air Conditioning, or Welding. Prepare in one year for position as Technician, or in two additional years secure your B.S. Degree in Electrical Engineering with major in Machinery or Electronics.

Write for booklet "Career Building"

**MILWAUKEE SCHOOL OF ENGINEERING**  
"A Technical Institute"

RM-847 N. Broadway and E. State, Milwaukee, Wis.

RADIO NEWS

## International Short-Wave

(Continued from page 116)

English announcements at 1500. (Pearce)

**Macao**—CR8AA, 9.254, is heard in Australia at 0600 with music, chimes, then news in Portuguese; QRM bad. (Sanderson) Heard poorly lately in New Zealand, news at 0650; Macao is verifying old reports (as far as 2-3 years back) with nice card. (Cushen) According to *Radio Australia*, uses 200 watts, and is scheduled 0430-0930; QRA is Post Office Building, Macao, Portuguese China. (Beck)

**Malaya**—A letter received by "The Broadcaster," Perth, from the British Far Eastern Broadcasting Service, Singapore, stated: "You will perhaps be interested to know that there are two entirely separate broadcasting authorities in Singapore. One is 'Radio Malaya,' which is a Colonial Government Department serving both Singapore Colony and the Malayan Union; the other is the British Far Eastern Broadcasting Service, which is a Foreign Office station serving non-British territories throughout the Far East and relaying the Eastern, Far Eastern and Overseas Services of the BBC. The frequencies in use for this Service are 15.300, 15.275, 11.735, and 6.770—from 0330 to 1200 on the two former frequencies and from 0325 to 1200 (EST) on the latter two frequencies." The 15.300 outlet is heard in Australia with news at 0415. (Sanderson) Heard in Britain with news at 1145, signing off with "God Save the King" at 1200, saying back at 0030. (Brownson)

*Radio Malaya* uses 620 kcs. and 4.825 on s.w., and relays over Radio Kuala Lumpur, 6.045; broadcasts in English, Malay, Chinese, Tamil. (Cushen)

**Radio Kuala Lumpur**, 6.045, is scheduled 0530-1030, except Saturday when runs to 1130. (NZDXC) Has news at 0600. (Sanderson) This is relayed from Singapore; carries news from own studios 0800. (Cushen)

**New Guinea**—Jungle Network, Biak, has been heard in California around 0450 to about 0635 on 7.198 (approx.); heard closing with "Gut Abend, Gut Nacht and Happy Land-ing." Plays American popular recordings. (Dilg)

**Northern Rhodesia**—ZQP, Lusaka, uses 3.914, 7.220 (actually appears to be as high as 7.285), and 9.705; latter with 2.5 kw., others 500 watts; daily official schedule is 1030-1200 for Africans, with English announcements; Sunday schedule is English program at 0400-0530, news at 0400. (Laubscher) Heard irregularly on West Coast, coming on at 1030 with drums. (Dilg, Baxter) It is possible by this time that ZQP will have changed schedule, to commence by 1000 or perhaps even as early as 0930.

**Norway**—LKJ, 9.54, Oslo, is heard in Australia at 1645 with news in Norwegian and music; LKQ, 11.73,



## WRL Globe Trotter Xmitter Kits

Giving 'round the world performance for amateurs 'round the world.

Hams everywhere say it's the hottest transmitter kit on the market. You will, too, once you've used it. It's a 40 watt input kit including all parts, chassis, panel and streamlined cabinet. Write for export prices. Cat. No. 70-300 less tubes ..... \$69.95  
Cat. No. 70-312 same as above, ..... 79.50  
wired ..... 79.50  
1 set coils, meter tubes, extra..... 17.15

## NO RED TAPE—WE FINANCE OUR OWN PAPER. USE LEO'S EASY PAY PLAN

LIBERAL TRADE-INS

Item	Cash Price	Down Payment
Halicrafters 338	\$ 47.50	\$ 9.50
Halicrafters 340A	89.50	19.90
Halicrafters 3P44	99.50	19.90
Halicrafters 5X42	275.00	55.00
Halicrafters HT-9	350.00	70.00
RME VH-F-152	86.60	17.32
RME-84	98.70	19.74
RME-45	198.70	39.74
Hammarlund HQ 129X	181.40	32.28
Hammarlund 5PC400X	334.05	66.81
National NC46	97.50	19.50
National 1-10A	67.50	13.50
National NC173	179.50	35.90
National NC240DT or NC240DR	225.00	45.00
National HRO-STAL or HRO-5RA	274.35	54.87
Pierson KP-81	367.65	73.53
Con-Set Converters	39.95	7.99
Collins 70E-8	40.00	8.00
Bud VFO-21	52.50	10.50
Weissner Signal Shifter	95.50	19.90
Abbott TR-4B Special	45.00	9.00
New Micro-Match Unit	29.50	5.90
Millen R-Per	24.75	4.95
BB-27 10 meter converter F.B. 348	27.50	5.50
Sonar Mobile MB-811 transmitter	72.45	14.49
MB-811 with power supply	81.45	16.29
WRL exciter unit wired	23.95	4.79
Millen 90800 exciter	42.50	8.50
Sonar XE-10 transmitter	87.45	17.49
Workshop 28 megacycle beam	39.50	7.90
3 element		
Workshop 8 element 28 megacycle beam	100.00	20.00
Workshop 20 meter beam		
3 element	120.00	24.00
Gordon Rotary Beam	225.00	45.00
Direct-O-Beam	117.00	23.40
New Beach ECO	32.50	7.50
4 Mid 1500 Volt DC Condenser	\$1.29	
0-500 D.C. Mills G.E. 2 1/2"		
Round Meter	2.95	
0-1 D.C. Mills—3 1/2" Round Meter	3.95	



## SENSATIONAL NEWS! TWO WEEK DELIVERY!

### SPEAKER REPAIR PRICE LIST

2"-3"-4"	\$1.20	10"	\$2.20
5"	1.30	12"	2.40
6"-4"x6"	1.40	15"	3.30
7"	1.70	5"x7"	1.90
8"-6"x9"	2.00		

Above prices do not include replacement of field coil.

Write for FREE Parts Buying Guide

## Globe Trotter Xmitter Kit

REALLY WORKS 'EM

Read what Herb Barnes, WIOTO, Says about this powerful, low cost kit

Leo (W0GFQ)  
World Radio Labs.  
Council Bluffs, Iowa

June 28, 1947

Hi Leo:

I've been meaning to drop you a line for quite some time now. I ran across your full page ad in the latest "QST" and it reminded me to do it.

Since I got my "Globe Trotter" last fall I've been having myself quite a time! Despite the fact that I'm a bed patient here in this hospital, and I work the 10 Meter Band only, here is a quick list of how the "Globe Trotter" and I have been doing the last 7 months:  
Over 650 FB QSO's! (nearly 100% at that!)  
Worked all U.S. Districts.  
Worked 37 of the States (don't worry, I'll get the rest!)  
Many swell contacts outside the U.S.; including the Hawaiian Islands; Europe; Mexico and Porto Rico!

Thought you might like to have the enclosed photo and QSL. Yep! That Mike I'm grabbing, came from you, too!

Me?? Well, I got banged up in the Navy in 1945, and I've been in hospitals ever since. I figured that ham radio would have to be the thing that would keep me from talking to myself. Your "Globe Trotter" seemed to fill the bill—so I got one, got a ticket, and got on the air! Been having myself a swell time ever since! The little rig sure delivers the goods!

Oh, yeah, Leo. I expect to get out of this place some day, and when I do, I'm going to want a rig with a little more power. Your new 250 watt rig sounds good. If it works out as well as the "Globe Trotter" in relation to its power, it will be something! So, will you please send me the dope on the new rig??

Well, Leo, that seems to be about all on this end, so I'll say '73' to you and

Adios and good luck, from (WIOTO)

Herb Barnes  
Sassaquin Hospital  
New Bedford, Mass

## LEO'S New 250 Watt XMITTER KIT

6 meters through 8. Phone—C.W. A compact, versatile unit to sell for about \$350, completely wired. Place your order now for first delivery.

FREE

**World Radio Laboratories**  
Department R-9  
Council Bluffs, Iowa

Send latest Free Flyer XMITTER

Send more data on the Globe Trotter

Send more data on

Name .....

Address .....

City .....

Call letters .....

Zone .....

State .....

# U.S.R.S.

**U. S. RADIO SUPPLY**  
5116 HARPER AVENUE  
CHICAGO 15, ILLINOIS  
DEPT. NE

# ELECTRICAL TRAINING

Intensive 52 weeks' residence course in fundamentals of industrial electrical engineering, including radio, electronics. Prepares for technicians, engineering aides. Approved for veteran training. 54th year. Catalog.

**BLISS ELECTRICAL SCHOOL**  
7698 Takoma Ave.  
Washington 12, D. C.

**FREE CATALOG**  
BIG G. & E. CATALOG OF RADIO, REFRIGERATION and ELECTRICAL PARTS, at today's lowest prices. Hundreds of new-est items in stock, immediate shipment. Send for your copy today.

**G. & E. EQUIPMENT SUPPLY CO.**  
400 N. Sangamon Street  
CHICAGO 22, ILLINOIS

for Hams - Experimenters -  
Industrial Users

## SLIP-RING ROTATOR



Will allow complete rotation of up to three stacked beam antennas, feeding each one individually through low-impedance lines. Usable wherever continuous rotation of up to four contacts is required.

- ★ 4 silver-plated slip-rings
- ★ 4 double-pronged silver contacts
- ★ high quality insulation, strong construction
- ★ easily mounted

Overall dimensions when assembled: 2" diam. 5 1/2" long.

POSTPAID IN U.S.A. **\$2.00**

Cut your Parts Bills  
in **HALF!**



For Money-Saving Values, send in your request for our GREAT BARGAIN BULLETIN.

- ★ BARGAINS GALORE
- ★ SURPLUS
- ★ STANDARD LINES

Place your name on our regular mailing list—fill in and return this coupon:

MERIT RADIO SUPPLY CO.  
471 Merrick Road,  
Lynbrook, N. Y.

Name.....  
Address.....  
City.....  
Amateur Call.....  
Experimenter.....  
Commercial User.....

**MERIT RADIO SUPPLY CO.**  
471 Merrick Road  
LYNBROOK, N. Y.

heard at 0145 with news in German and musical program, 10 notes on piano as interval. (Sanderson)

LKV, 15.170, Tromsø, heard in Britain from 1100 in parallel with other outlets; has news in Norwegian at 1600; no *English*; power 10 kw. according to airmail QSL.

Panama—Schedule of HP5H, 6.122, Panama City, is now 0630-000. (Beck)

Paraguay—ZPA-5, 11.948, Encarnacion, logged through terrific CWQRM from 1755 to sign-off at 1840; news in Spanish at 1830; signal fluctuated considerably. (Kary)

Philippines—KZRH, 9.640, Manila, is heard with fair to good level in the East early mornings; news 0530. Miss Sanderson, Australia, reports program details at 0415. Cushen, New Zealand, says is in clear there now 0000-0400, since BBC removed GVZ from Pacific Service.

Poland—Warsaw, 6.11, during summer has had news at 1450 instead of 1550 as was the case in winter.

Siam—Bangkok, 6.125 (or 5.990, alternating), is heard to 0630 and again to sign-off at 0915. (NZDXC) News is scheduled for 0615.

Sierra Leone—Freeton, 8.125, reported heard Sundays only, beginning 1530. (Harrison) May be using a 19-m. frequency also; I understand this station wants reception reports.

Surinam—PZR, 11.332, Paramaribo, "Avros, Paramaribo," is being widely heard, late afternoon and evenings. Announces in Dutch and plays many American popular recordings.

Sweden—An order has been placed with a British radio concern for two 100-kw. transmitters for the new s.w. station at Horby, at a cost of 1.9 million kroner; these stations are expected to be ready for operation in two or three years.

Switzerland—Regularly scheduled transmissions from the *United Nations Radio*, Geneva, should be on the air shortly; has been conducting experimental transmissions for some months now. Reports should be addressed to Robert Nivelles, in Charge of Radio, Information Centre, European Office of the United Nations, Geneva, Switzerland.

Berne's HER7, 17.784, opens at 0955 with usual chimes; man announces (in *English*) at 1000 as operating on 15.305 and 17.784; woman then begins Swiss home news in *English*; 1100-1159 French is used; signs off then with march. (Kary)

Turkey—Cavad Memduh Alta, director, Radio Branch, Turkish Press Department, Ankara, advises Paul Kary that TAQ, 15.195, normally does not carry *English*, but it is used at times for relaying American correspondents to U.S. networks; has been so heard by Kary at 0800-0815; Ankara verified his reception of TAQ.

U.S.S.R.—Best heard lately in Moscow's North American beam, 0745-0815, mornings, and 1820-1950, evenings, are 17.839 and 15.170. Other morning frequencies include 11.75, 15.11, 15.23, 21.55. In the evening,

## HAM RECEIVER \$12.95

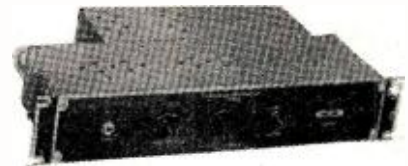

WAR SURPLUS CW-3

Save on the war surplus CW-3. Crystal controlled superhet with 6 tubes, R.F. sensitivity control, audio gain control, noise suppressor, single stage amplifier, oscillator-mixer, single stage amplifier, a second detector and voltage amplifier, and audio output stage. Brand new in original cartons, with set of 3.5 to 6.1 meg coils and extra set of tubes. Your cost \$12.95.

10% Cash with Orders



509 ARCH ST. PHILADELPHIA, PA.

### SENSITIVE RELAYS

Sigma 4AH SPDT, 2000- $\omega$ , 4-ma in, 1.5 ma. out, shielded 5-prong plug-in. #R28.....	\$0.95
Same but 2500- $\omega$ . #R29.....	.95
Clare SPDT, 3500- $\omega$ , 6-ma. #R30.....	.79
Guardian SPST Norm Open, 40- $\omega$ , 6-Volts. #R31.....	.49
Edison Thermal Time Delay, SPST Norm Open, 110-v, a-c or d-c, 45 sec start, 10 amp contacts. #R32.....	1.39
Allen Bradley Solenoid, SPST, Norm Open, 200- $\omega$ , 24-v, 50-amp contacts. #R33.....	.79

### CHOKES

Raytheon, 25-H, 30-ma, 850- $\omega$ , 2 1/2 x 2 1/2 x 2 1/2 4000-v insul. #T32.....	\$0.69
General Trans, 11-H, 40-ma, 350- $\omega$ , 2" diam x 2 1/2. #T33.....	.59
Westinghouse, 4-H, 90-ma, 300- $\omega$ , 2" dia x 3". #T34.....	.59
G.E., 325-T, 5500- $\omega$ , plate chk, 1 1/2 x 2 1/2 x 1 1/2 h. #T35.....	.59
Potter, 25H, 30 ma, 400- $\omega$ Center Tpd, 2" dia x 4". #T36.....	.95

### TRANSFORMERS

Output, PP 2A3 CIs A or PP 6L6 CIs AB2 to 1.5, 3, 5, 8, 15; UTC P.A. Series. #T37.....	\$2.95
Cls B Intrigue; Driver Plate to PP grids upright shielded type. #T38.....	1.59
Audio, 4-1, 2 1/2 x 2 1/2 x 3 1/2 Ferranti. #T39.....	.75
Mike or line to Grid Ferranti 2 1/2 x 2 1/2 x 2 1/2. #T40.....	.75

Write for free info on VTVM and other kits from \$9.95 up. Hundreds of other bargains in radio and electronic parts and kits.

**UNIVERSAL GENERAL CORP**  
365 CANAL STREET, NEW YORK CITY  
Walker 5-9642

## BRAND NEW NAVY SURPLUS HI-FI PUSH-PULL AUDIO OUTPUT TRANSFORMER

Made for E. H. Scott's Navy Model REE entertainment receiver. Imp: pri 4400  $\sim$  ct; sec's 4, 60 ct, 200, 300, 600  $\sim$ . Fully cased. 5 lbs. Matches push-pull 6L6's, 25L6's, 50L6's. Tested at 18 watts power output into 4  $\sim$  load, O.K. Excellent transient response; with 1,000 cps square wave input at 20 watts, input and output waveforms look exactly alike on scope. Can also be used for remote speakers, 600  $\sim$  winding to line, 4  $\sim$  to voice coil. 60  $\sim$  winding used to provide inverse feedback voltage. With each order will include schematic of the REE's power supply and audio section which is flat ( $\pm$  2db) 70-10,000 cps. (The 70 cps figure is not due to the transformer, which is flat down to 20 cps.) Tell your friends about this ad. Quantity limited. Order immediately!

Only \$1.89 each!

Please remit with order. Shipping wt. 6 lbs. for 1, 11 lbs. for 2, etc. Include reasonable amount for parcel post, will refund excess.

**THE GOODHEART CO.**

2616 N. Spaulding Ave. Chicago 47, Ill.



paralleling are 11.89, 15.23, and others, irregularly.

Komomolsk, Khabarovsk Territory (Siberia) has recently been heard in British Columbia on 9.565 at 1545, with news in Russian at 1600; clock heard striking, followed by station announcement; "Gavoritt Khabarovsk" (or "Talking Khabarovsk"). (Verigin) RV64, also Siberia, heard back on summer frequency of 8.820 where has strong signal in British Columbia, but distortion is as bad as ever. (Park)

### Last Minute Tips

Direct from Carl Etienne, HHCN, Port-au-Prince, Haiti, comes word that HHCN, Station de Radiodiffusion, began operations July 15 on 5.660 with daily schedule of 1700-2100, power 100 watts. Announcements are made in French, Spanish, and English. "We will verify all reception reports," says Mr. Etienne, who gives "correct" address as Station HHCN, Avenue Christophe No. 55, Port-au-Prince, Haiti, W. I. Additional information given by Mr. Etienne is:

"The latest and most prominent news in broadcasting in Haiti is that the Chamber of Deputies just approved a law introduced by the Executive and upon which broadcasting over 5 kw. will be a State Monopoly. Except in Port-au-Prince, the Capital city, where four s.w. stations operate (HH2S, 5.945; HH3W, 10.105; HHCM, 6.160; HHCN, 5.660), only Cap-Haitien has one, HHCP, working in the 40-meter band—totaling less than 2 kw. There are also three long-wave stations in Port-au-Prince. In all Haiti there are about 3000 radio receivers. Haiti has an area of about 29,536 square miles and is bounded on the east by the Dominican Republic. The population is about 3,500,000 people. Port-au-Prince has a population of about 250,000. Haiti is an agricultural country. Principal crops are coffee, bananas, corn, rice, sugar, cotton, cacao, and sisal. There are very few industrial plants."

From A. Cross, of the Trinidad Broadcasting Company, Ltd., Broadcasting House, Port-of-Spain, Trinidad, B.W.I., comes this word: "Just now we are off the air due to a breakdown of the modulation transformer and we await replacements from the States due August 15. Our station is due to open *officially* on August 31 if there is no further delay on this replacement transformer." (Ferguson) Watch for this station with call of VP4RD on 9.635 around 0600 and on 6.085 around 0635 for tests.

We have just received a flash from a reliable source that a new outlet of the Spanish-speaking countries is in the making, with transmitting equipment to be located on Fernando Po Island, off the West Coast of Africa. Our informant reports: "Boasting a power of 200,000 watts, the antenna will be a 4-beam unit, beaming programs to Europe, North America, South America, and the Far East. Programming will be in all languages.

September, 1947

# TERMINAL IS YOUR BEST BET for Everything in Television!

**TELEKITS**, manufactured by Electro-Technical Industries, were designed by Television Training Institute—America's foremost television specialists. Instructions furnished with each kit are complete in every detail—schematics, pictorial wiring diagrams, photographs and step-by-step instructions made easy by top-flight television experts!

**IN STOCK FOR IMMEDIATE DELIVERY!  
NO WAITING! SAME DAY SHIPMENT!**

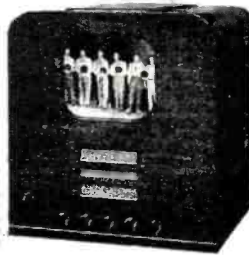

You get the same detailed instructions followed successfully by thousands of students in the leading television schools who include these kits in their regular television training courses!  
**It's fun learning television by building your own — and you save PLENTY at Terminal!**

### PERFECT PERFORMANCE GUARANTEED

Providing instructions are followed correctly! FREE guarantee service available coast-to-coast! Telekit Service Labs in all principal cities!

### 7" Electro-Tech TELEKIT

New advanced television receiving circuit uses only five control knobs for perfect picture and high fidelity F.M. sound. Comes complete with high quality parts (famous brand names!) pre-tuned I.F. coils, punched chassis, wire, hardware and easy-to-follow instructions. Three fixed-tuned bands. Tubes required: 1—4J4, 1—5U4G, 1—2X2/879, 1—6V6, 1—XXFM, 6—6SN7, 5—6AC7/1852, results assured! For operation on 105-125 volts, 60 cycles, AC.

#7 TELEKIT, complete, but less tubes and cabinet .....

**77<sup>50</sup>**

Complete kit of matched tubes, including RCA 7GP4 7" picture tube..

**39<sup>95</sup>**

Cabinet for above kit, walnut finish..

**22<sup>50</sup>**

Front Panel only [not required if cabinet is ordered] .....

**7<sup>00</sup>**

### 10" Electro-Tech TELEKIT

The 10" Telekit incorporates the new TTI interlock circuit for horizontal and vertical sync control. Features include 5 bands, electromagnetic scanning and focusing, pre-tuned I.F. coils, 9500 volt power supply for 10" tube, two separate low voltage power supplies, high fidelity F.M. sound. Only five control knobs used. Tubes required: 1—4J4, 1—XXFM, 1—6V6, 1—6AC7/1852, 4—6AG5, 5—6SN7, 1—6B6G or 807, 1—5Y4G, 1—183GT/8016, 2—5U4G, 1—10BP4. Complete with all parts, punched chassis, wire, hardware and easy-to-follow instructions. For operation on 105-125 volts, 60 cycles, AC.

#10 TELEKIT, complete, but less tubes and cabinet .....

**124<sup>50</sup>**

Complete kit of matched tubes, including RCA 10BP4 10" Bright Picture tube .....

**65<sup>35</sup>**

Cabinet for above kit, walnut finish..

**29<sup>50</sup>**

## RCA TELEVISION COMPONENTS — IN STOCK!

For television engineers, experimenters and servicemen, Terminal maintains a complete, up-to-the-minute stock of television parts! Of course, we have Everything in Radio!

Width control, type 201R1 .....	.76
Projection size control, type 201R2 .....	1.29
Horiz. Linearity control, type 201R3 .....	.82
I.F. & Video coil kit, type 204X1 .....	19.40
Filament choke, type 204L1 .....	.17
Horiz. sync. discriminator, type 208T9 .....	2.79
Deflection yoke (direct view), 201D1 .....	8.08
Deflection yoke (projection), 201D2 .....	8.76
Yoke mounting hood, type 201X1 .....	1.62
Focus coil, type 202D1 .....	5.34
Ion trap magnet, type 203D1 .....	3.82
Horiz. output transformer, 204T1 .....	13.52
Horiz. output transformer, 204T3 .....	8.56
Horiz. output transformer, 211T1 .....	9.90

### TELEVISION TUBES

RCA 5BP4 .....	27.50
RCA 7DP4 .....	27.00
DuMont 7EP4 .....	23.25
RCA 7GP4 .....	24.25
RCA 5TP4 .....	67.50
RCA 9AP4 .....	62.50
RCA 10BP4 .....	49.50
Rauland 10FP4 .....	42.20
RCA 12AP4 .....	75.00
DuMont 20BP4 .....	275.00

Horiz. output transformer, 211T2 .....	13.38
Vertical output transformer, 204T2 .....	5.29
Horiz. bl.-osc. transformer, 208T1 .....	3.53
Vertical bl.-osc. transformer, 208T2 .....	3.35
Horiz. bl.-osc. transformer, 208T3 .....	2.67

### RCA Bright Picture Antennas for Clear All-Channel Reception

Dipole kit, type 224 .....	5.88
Dipole/reflector kit, 225 .....	8.82
Universal mtg. brackets for above kits, type 227, per pair .....	4.41
RCA Bright Picture Transmission line, per 100 ft. .....	2.79



**WARRANTY** — No change in our policy. Every item we sell is fully guaranteed, regardless of its low price.

If unable to visit our store, send us your mail orders with 25% deposit. Remit in full all orders under \$5.00. Prices are F.O.B. New York.

## TERMINAL RADIO CORP.

85 CORTLANDT STREET • NEW YORK 7, N. Y.

Phone: WOrth 2-4415

Cable Address: TERMRADIO

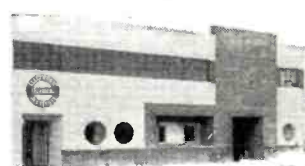

**BE SECURE in a Well Paid Profession.**  
Classes Starting in September. Investigate Our Courses Now.

## Learn RADIO-ELECTRONICS

APPROVED FOR TRAINING UNDER GI BILL

Big opportunity now available for well trained men. Learn the magic of Television, Frequency Modulation, Transmitter and Receiver Theory. Instruction with Sound Motion Pictures. Start a spare time business while learning.

WITHOUT OBLIGATION SEND FOR FREE 1947-1948 YEAR BOOK

Name..... Address.....  
City..... State.....

**ELECTRONIC TECHNICAL INSTITUTE**  
771 Venice Blvd., RN-9, Los Angeles 15, Calif., RICHMOND 9573

I am interested in:  
 AMATEUR RADIO COMMUNICATIONS  
 Television  
 Radio Servicing & General Electronics  
 Home Training  
 Amateur Radio Correspondence Course



ALL CLASS ROOMS HAVE NEW AND LATEST TEST AND LABORATORY EQUIPMENT AVAILABLE FOR STUDENTS' USE

**ATTENTION: PROSPECTORS-EXPLORERS  
FIND HIDDEN TREASURES!**

Do you seek hidden treasures or rare metallic ores? If so, construct a U.S. Army Type of Metallic Mine Detector from these U.S. Army Mine Detector Amplifiers that we are offering at a ridiculously low price. Complete Amplifier (as illustrated) (less tubes and batteries) with Battery case and cables. Cables, headphone cord and jack (no phones). Complete Army wiring diagram. U.S. Army DETECTOR SET Amplifier Type AN/PRS-1, as described. . . . . Only **\$2.95**

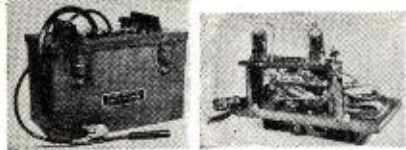

No C.O.D.'s. Eveready 45 volt batteries #482. \$1.65 ea., 6 volt A. 73c. 2-1N5 tubes. 95c ea. U.S. SIGNAL CORPS 5 METER SHORT WAVE XMTRS.

(72.2Mc) XMTRS and TUBE only less mike, batteries and antenna. One 1 1/2 volt dry cell and 67 1/2 volts of B operates it. Just attach di-pole, key or mike, connect the batteries and it's ready to use. Signal Corps spec. wired with silvered wire, mica condensers, and precision resistors. Highly stable circuit with Lo-Loss silvered inductance. (Adjustable padder) Schematic supplied. Converts easily to walkie-talkie and Ham bands. **\$2.95**

Only No C.O.D.'s

**FEDERAL SELENIUM RECTIFIERS**

Lots of 12. . . . . 75c  
Single Lots . . . . . 80c

BRAND NEW WESTON SENSITIVE RELAYS  
MICRO-AMMETERS MODEL 705

(2 1/2-0-2 1/2 2-0-2 range)  
Cost Uncle Sam \$45.00. Our price \$10.00 with A.C. Rectifier.

GENUINE SIGNAL CORPS FEATHER-WEIGHT HEADPHONES WITH CORD AND PLUG 2000 OHMS-8000 OHMS IMPEDANCE . . . . . **\$1.00**

**NEWARK SURPLUS MATERIALS CO.**  
324 Plane Street Dept. N. Newark 1, N. J.

**Jobbers! This New Deluxe Line of  
Volume Controls**



Meets YOUR Requirements!

INDIVIDUALLY BOXED

This new deluxe line of volume controls is suitable for general replacement, and is expressly designed for jobbers. All types and ohmage.

**POTENTIOMETERS**

Specially Designed for TELEVISION

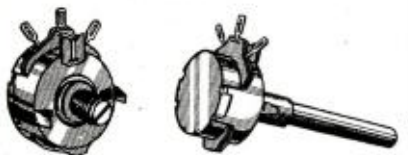

All Types and Ohmage

**AC-DC RESISTANCE CORDS**

Complete Line—All Sizes and Ohmage

Standard discounts to Jobbers Write for literature!

**AMERICAN VOLUME CONTROL CORP.**  
115 Liberty Street  
New York 6, N.Y.

Daytime operation will be in the 20-30-m. vicinity, shifting to about 50 meters for night operations. The station identification is as yet unknown, but it is expected to be on the air by the autumn of 1948. Sponsoring the station is Compania de Radiodifusion Intercontinental, well-known in Spanish broadcasting circles."

Vatican—During the summer, HVJ, Radio Vatican, has been audible some days on 15.095 during the 0900 news period; at times is buried by Montreal's 15.090 outlet. Announces 9.660 in dual, and that 9.660 and (about) 5.971 are used for a further (English) period 1315-1330 daily. During the winter the morning news from HVJ will be heard one hour later, 1000.

The 9.660 frequency is heard in Britain signing on at 1245 with a program in German; English at 1315, as scheduled, announcing (about) 5.971 in dual. (Pearce)

\* \* \*

The National Catholic Welfare Conference, Washington, D.C., has been given permission to reprint the story on Vatican Station HVJ (June ISW Department). A dispatch commenting on the article was released by NCWC to the Catholic press, also.

KZPI, Manila, has been using 9.695 instead of 9.710 for some time now; signal seems improved, may have increased power. (Dilg) Heard in New Zealand at 0445, stating that all reports will be verified.

Beira still appears to be on 7.155 although in verifying gave frequency as 7.255; the QSL card they send is white with dark red and green stripe (national colors, probably), corner to corner, diagonally. Data on card is in black; actual verie portion is in Portuguese; it is suggested that collectors specify the QSL card or may get only letter-verie; it would be well to enclose IRC. (Laubscher) Mr. Laubscher was informed—from QRA of CR7IB, Emissora do Aero Clube da Beira, P.O. Box 3, Beira, Mocambique—that this station has "made appeals to listeners to inform us on the reception of our stations, for we now wish to know for certain how far our stations can be heard, for future transmissions." It was further stated that this request was made after receipt of several reports from ISW monitor Sidney Pearce in England that the station was being heard well there.

Hongkong's ZBW has had an improved signal lately on West Coast; appears lower in frequency, around 9.510, where is in clear of Perth's VLW7, 9.520. (Dilg) I have been hearing a station on this channel around 0630 with Chinese that is possibly Hongkong. Miss Sanderson, Australia, reports ZBW at 0445 with BBC relay and music.

Kary, Pennsylvania, reports that on occasion, XGOY's 11.913 outlet (scheduled to close at 0530) has been heard recently as late as 0645; location Chungking.

A "new" Indonesian has been logged

**PITCO LINE FILTERS**



• 5 Amp. 110-220 Volts. A.C. or D.C.  
• 10 Amp. 110-220 Volts. A.C. or D.C.

**Highest Quality . . . Dependable Performance**

Exhaustive tests and actual operating performance have definitely proven the superiority of the Pitco Line Filter over other designs. This dependable unit presents a solution to the problem of serious radio interference from power lines, motors, and appliances . . . provides inductance as well as capacitance, thereby assuring thorough filtering action.

The Pitco Line Filter plugs into the electrical outlet and can be connected at the receptacle of the filter with either the radio set or interfering device. Wherever installed, you'll find this sturdy, compact filter is unsurpassed for high quality and outstanding performance.

See the Pitco Line Filter at your local distributor today. He has both the 5 Amp. and 10 Amp. sizes ready for immediate delivery.

FOR COMPLETE DETAILS, SEE YOUR DISTRIBUTOR OR WRITE DIRECT.

**Pittsburgh Coil Co., Carnegie, Pa.**

Coils • Test Leads • Line Filters • Indoor Aerials

**BONAFIDE VALUES**



**SHURE T17B**  
Push Button Carbon Mike  
**\$7.98**  
With Cord and Plug Value \$12.00



**SHURE CRYSTAL MIKE**  
**\$6.95**  
With Stand, Base, and 7 Ft. Cable Value \$18.50

- Detroit Record Changer . . . . . \$14.69
- Webster 56 Automatic Stop . . . . . 25.95
- Seeburg 2 Post Changer . . . . . 23.97
- McGuire 2 Post Changer on Base, Automatic Stop . . . . . 14.95
- A-C Motor & Astatic L-70 Pick-up . . . . . 4.75
- 5" PM Speaker (Alnico) . . . . . 1.39
- #3" Heavy Slug Speaker—Nylon Cone . . . . . 1.98
- #2" Heavy Slug Speaker or Mike Comb . . . . . 1.49
- 1/2 Meg. Vol. Cont. & Sw.—Lots of 6 . . . . . .49
- Federal Selenium Rect.—100 Mill— . . . . . .69
- 100 IRC Resistors Assorted Sizes & Watts . . . . . 1.79

25% DEPOSIT. BAL. C.O.D. PLUS CHARGES WRITE FOR LATEST CATALOG

**BONAFIDE RADIO CO.**

89 1/2 Cortlandt St., Dept. A, N. Y. 7, N. Y.



**Amazing! POCKET OR PURSE SIZE NEW RADIO**  
WORLD'S SMALLEST RADIO KNOWN!  
Wt. only 4 lb. Beautiful Silver Black plastic case. Has Inductive Slide Tuner—WA Crystal Diode—NO TUBES, BATTERIES OR ELECTRIC "PLUG IN" NEEDED! Should last for years!  
**GUARANTEED TO PLAY**  
NEW 1948 MODEL  
on local stations if complete instructions sent are followed. Use it at home, in bed, in many offices, hotels, cabins—most anywhere! HUNDREDS OF SATISFIED CUSTOMERS ALL OVER THE WORLD!  
SEND ONLY \$1.00 (Cash, M.O. Check) and pay postman \$2.99 plus delivery. Complete as shown—ready to play with self contained personal phone. WONDERFUL GIFTS FOR CHILDREN! Order now at this low bargain price—Prompt shipment on orders sent now—today! Be the first to get YOUR Pocket Radio! (All foreign orders \$5.00 U. S. cash with order.)  
Pa-Kette Radio Co., Inc. Dept. RN-9 Kew-Forest, N.Y.



**TRUCK FOR APPLIANCES**  
Rolls like baby buggy on 4 big (Dual) 8" rubber tires; resilient, quiet, durable; Chrysler Oilite bearings. Easily handles refrigerators, and all appliances up to 1000 lbs., 54" ht.; 24" nose; 13" web strap. Also handles crates, boxes, bags, etc. \$31.95 f.o.b. Over 10,000 Handee trucks sold by mail. Send back express collect if not satisfied. Order Monday—get Friday, from  
**HANDEES CO., Dept. RN-9, Bloomington, Ill.**

**LCETI**

**RADIO NEWS**

on about 6.600 with an *English* period, 0530-0630. (Dilg)

*Radio Sofia*, Bulgaria, is sending out a new QSL depicting a map of Bulgaria. Still has news at 1530 on 9.350 and closes at 1540; asks for reports to *Radio Sofia*, Anglo-American Service, Sofia, Bulgaria. (Pearce)

A Chinese station heard for some time on about 7.100 with call sounding like XGAF or XGOF, now seems to have a dual outlet on about 11.675; at 0800 now gives some news (in *English*), "read by an American who is in a hurry; he says it is the U. S. Radio Service in Los Angeles with United Press releases." Chinese and western type music alternate at times; once at 0700 carried an oration (in Chinese), same program as on XTPA, 11.65, Canton, and XORA, 11.725, Shanghai. (Dilg)

A French-speaking station has been picked up in California, mornings, on about 9.470; heard with *English* at 0715, ending with "Good night, everybody," followed by talk in French. (Dilg) May be a Hanoi outlet.

CE-1180, *Radio Sociedad Nacional de Agricultura*, Casilla 40-D, Santiago de Chile, verified a report sent in Spanish with QSL in *English*. (Bachman)

In a more recent DX broadcast, *Radio Australia* gave "revised" schedule of ZQP, 9.705, Lusaka, Northern Rhodesia, as 1030-1130 on Sundays, 1030-1200 on weekdays.

Tananarive, Madagascar, 9.695, heard on West Coast signing off at 1245, S4, signal. (Nankervis)

\* \* \*

#### Acknowledgement

Many thanks for the fine reports coming in. They should be mailed to reach your SW editor at 948 Stewartstown Road, Morgantown, West Virginia, U. S. A., by the sixth of any month. Monitor cards for 1947-48 are being sent out to all active reporters, and new monitors will be welcome from any place in the world. . . K.R.B.

#### CARDBOARD SPACER

A **CARDBOARD** spacer may be cut with an opening to permit forcing over the coil form.

This cardboard has the corners rounded so that the coil shield will just slip over the spacer when in place.

This keeps the shield in line and away from coil windings and terminals. H.L.



September, 1947

**ATTENTION DISTRIBUTORS • MANUFACTURERS!!**

# SENSATIONAL VALUES ON W.A.A. RADIO and ELECTRONIC EQUIPMENT

**PRICED  
for  
QUICK  
SALE**

**COMPLETE INVENTORY  
of  
ELECTRONIC EQUIPMENT  
and  
COMPONENT PARTS**

.....  
**WRITE TODAY FOR CATALOG!!**  
.....

## AUTOMATIC RADIO MFG. Co., Inc.

Agents For

**WAR ASSETS ADMINISTRATION**

30 WASHINGTON STREET

BRIGHTON, MASSACHUSETTS

**ATTENTION—RADIO SET BUILDERS!**

• Special Values •

**ALL NEW NATIONALLY KNOWN BRANDS**

G.E. 12" P.M. Spkr. Alnico 5 magnet, ideal for FM-AM and P.A., less transf. . . . ea. \$9.80  
Phono Motors—110v. A.C. 78 R.P.M. Rim Drive, complete for 10" or 12" Records . . . ea. 2.95  
Shure P87B or P94B Phono Pickup, or Astatic L70 or L71 Phono Pickup . . . ea. 2.45  
**ALNICO MAGNET SPEAKERS**  
5" P.M. . . . ea. \$1.59 6" P.M. . . . ea. \$2.30  
8" P.M. . . . ea. 3.85 12" P.M. . . . ea. 6.95  
2000 Ohm Headset Army type #HS-16-A . . . ea. 1.85  
8000 Ohm Headset Army type #HS-23 with adj. band, rubber ear covers . . . ea. 1.95  
100 asstd. insulated resistors . . . kit 2.00

**FREE—SEND FOR OUR FREE PRICE LIST TODAY!**

**ELECTROLYTIC CONDENSERS** (name brands)

8x8 mfd. 475 v., 4 prong plug-in 1 1/2" dia. x 4 1/2" L. . . . ea. .65  
16 mfd. 450 v. cabd. tubular 7/8" dia. x 2 1/2" L. . . . ea. .60  
40x40x20—150 v., 25 v., 25 v., FP Type 1 1/2" x 2 1/2" L. . . . ea. .65  
40x40 mfd.—150 v., 25 v., FP Type 1 1/2" dia. x 2 1/2" L. . . . ea. .60  
50x30 mfd.—at 150 v. each, cubd. tube 1 1/2" dia. x 2 1/2" L. . . . ea. .55  
80 mfd. 150 v., cabd. tube 7/8" dia. x 2 1/2" L. . . . ea. .55  
6 volt 4 prong non-syn. vibrators . . . ea. 1.25  
2 volt 7 prong syn. vibr. replacement for G.E. portable sets, LB300 & LB300X . . . ea. 1.85

**MAIL ORDERS FILLED! IMMEDIATE SHIPMENT!**

**UNUSUAL VALUES—**  
Signal Type Telegraph Hand Key . . . ea. .49  
Weston Type 476 A.C. Voltmeter, 0-130 v. . . ea. 4.95  
Pin Straightener for ALL Miniature Tubes . . . ea. 1.25  
G.E. Full Wave Selenium Rectifier, 50 ma., 250 v. A.C. . . . ea. .90  
Leach DPDT 110 v. A.C. Relay . . . ea. 2.25  
1 meg. Vol. Cont. with Switch . . . ea. .48  
2 meg. Vol. Cont. with Switch . . . ea. .48  
500M ohm Vol. Cont. with Switch . . . ea. .48  
25 asstd. popular sizes volume controls without switches . . . lot 3.50

**20% Deposit on All Orders Please Add Sufficient Postage**

**VERY SPECIAL OFFER!**  
FM FOLDED-DIPOLE ANTENNA FOR USE ON NEW FM BANDS. HIGH GAIN—300 OHM IMPEDANCE, each **75c**  
Special—10 for \$6.50

**ORDER NOW—QUANTITIES LIMITED!**

**METRO RADIONIC CO.**  
79 FOURTH AVE. NEW YORK 3, N. Y.

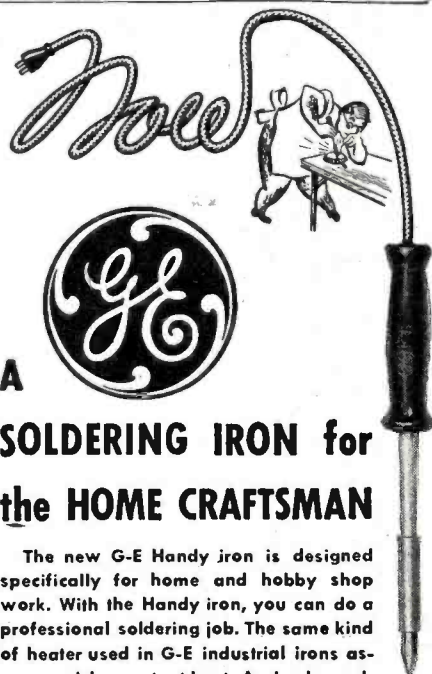

The new G-E Handy iron is designed specifically for home and hobby shop work. With the Handy iron, you can do a professional soldering job. The same kind of heater used in G-E industrial irons assures quick, constant heat. And a brazed-on tip flows the heat to your work faster. Built for a wide variety of home soldering jobs, the Handy iron is a tool you'll use often. Only \$3.95. Ask to see it at your dealer's. Or write to Dept. D667-3K, Apparatus Dept., General Electric Company, Schenectady 5, N. Y.

**FREE: A "how to solder" manual with every iron** 687-3K

**GENERAL ELECTRIC**

179

# SELENIUM RECTIFIERS

FOR ALL APPLICATIONS

## HALF WAVE TYPES

Input	Output	Current	Price
From 0-18 V.A.C.	From 0-14 V.D.C.	3 AMP.	\$2.25
0-18 V.A.C.	0-14 V.D.C.	5 AMP.	2.95
0-18 V.A.C.	0-14 V.D.C.	10 AMP.	4.95
0-18 V.A.C.	0-14 V.D.C.	15 AMP.	6.95
0-18 V.A.C.	0-14 V.D.C.	20 AMP.	8.95
0-18 V.A.C.	0-14 V.D.C.	25 AMP.	10.95

Input	Output	Current	Price
From 0-36 V.A.C.	From 0-28 V.D.C.	3 AMP.	\$2.95
0-36 V.A.C.	0-28 V.D.C.	5 AMP.	4.95
0-36 V.A.C.	0-28 V.D.C.	10 AMP.	7.95
0-36 V.A.C.	0-28 V.D.C.	15 AMP.	10.95
0-36 V.A.C.	0-28 V.D.C.	20 AMP.	13.95
0-36 V.A.C.	0-28 V.D.C.	25 AMP.	16.95

## FULL WAVE BRIDGE TYPES

Input	Output	Current	Price
From 0-18 V.A.C.	From 0-14 V.D.C.	5 AMP.	\$4.95
0-18 V.A.C.	0-14 V.D.C.	10 AMP.	7.95
0-18 V.A.C.	0-14 V.D.C.	15 AMP.	10.95
0-18 V.A.C.	0-14 V.D.C.	20 AMP.	13.95
0-18 V.A.C.	0-14 V.D.C.	25 AMP.	16.95
0-18 V.A.C.	0-14 V.D.C.	30 AMP.	19.95

Input	Output	Current	Price
From 0-36 V.A.C.	From 0-28 V.D.C.	5 AMP.	\$7.95
0-36 V.A.C.	0-28 V.D.C.	10 AMP.	13.95
0-36 V.A.C.	0-28 V.D.C.	15 AMP.	19.95
0-36 V.A.C.	0-28 V.D.C.	20 AMP.	25.95

It would be impossible to give a complete listing of all our rectifier types. Our engineering staff is at your service to help you work out the application of selenium rectifiers to your specific problems. Write us for quotations or further information.

Send check or money order  
25% Deposit required on all C.O.D.s.

**OPAD GREEN COMPANY**  
191 GREENWICH STREET  
NEW YORK 7, N.Y.

**RCA Institutes, Inc.**  
Offer thorough training courses in all technical phases of Radio and Television  
WEEKLY RATES: DAYS—EVENINGS  
VETERANS: RCA institutes is approved under G. I. Bill of Rights  
For Free Catalog write Dept. RN-47  
RCA INSTITUTES, Inc.  
A Service of Radio Corporation of America  
75 Varick St., New York 13, N. Y.

**FLASH-O-TEST**  
CONTINUITY TESTER AND FLASHLIGHT, COMBINED  
NEW! Nothing like it on the market.  
USE: As probelight and testing continuity, shorts, open circuits, etc.  
EQUIPPED WITH: Two batteries and bulb. Plastic case. Long leads with clip and prod.  
\$2 POSTPAID. Immediate Delivery  
STERLING ELECTRONIC CO.  
BOWLING GREEN, KENTUCKY

**20 STEPS TO PERFECT AMPLIFICATION**  
1948 AMPLIFIER BOOKLET  
by A.C. Shoney  
SEND 3c STAMP FOR POSTAGE  
**AMPLIFIER CORP. of AMERICA**  
398-2 Broadway New York 13, N. Y.

# NEW RECEIVERS for Fall Market



## PORTABLE RADIO

Arc Radio Corporation of Brooklyn is currently in production on a new small sized portable receiver known as "Porty No. 601."

This receiver which weighs only 72 ounces and measures 7½" x 9½" x 3" is bound in leatherette in different styles and colors. An adjustable match-



ing strap for shoulder or hand carrying makes this unit particularly adaptable for travelling.

Fingertip control of volume and station selectors plus a 4" PM speaker are special features of this receiver. Although designed as an "individual" receiver the unit provides sufficient volume for group listening.

Arc Radio Corporation of Brooklyn, New York will supply further information on "Porty No. 601" upon request.

## COMBINATION UNIT

Electronic Laboratories, Inc. of Indianapolis have recently added a new



10-tube console radio-phonograph to their line of home receivers.

This new unit, which is available in

mahogany, walnut, or blonde finishes, incorporates two speakers and two separate amplifiers for individual tone control. An automatic intermixed 10 or 12 inch record changer is used and storage space for 10 albums or 120 single records is provided.

Additional features of this new receiver include push-pull output, dual speaker system, superheterodyne circuit, a.v.c., and the company's new vario-tuner. A built-in antenna is also provided. Standard models are for operation on 105-120 volt, 50-60 cycle a.c. while special d.c. models to operate on 105 to 120 volts will be available at a slightly higher cost.

Electronic Laboratories, Inc., Indianapolis, Indiana will supply additional details on request.

## TABLE MODEL

In response to consumer demand for a low-priced radio, Garod Radio Corporation has introduced the "Ensign," an a.c.-d.c. table model receiver.

Designated as the Model 5A1, this table model utilizes four multi-purpose tubes plus a rectifier. A built-in loop

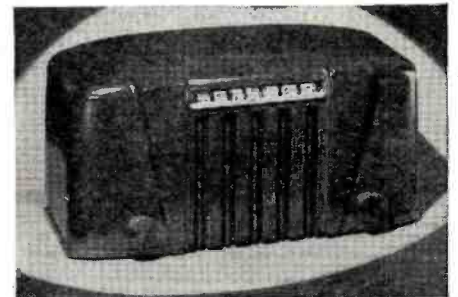

antenna and slide-rule dial with full standard broadcast calibration from 540 to 1650 kc. plus the newly developed Garod Alnico speaker, are added features of this radio.

This model is available in either walnut or ivory plastic. Garod Radio Corporation, 70 Washington Street, Brooklyn 1, New York will supply complete information on request.

## "SCOTTIE CONVERTIBLE"

Currently being released to dealers, the new 1948 Remler "Scottie Convertible" incorporates several unique features.

Designed to meet the demand for a moderately priced radio-phonograph, this unit measures 6¾" x 7" x 10". The phonograph features a constant-speed, worm-gear drive and both turntable and motor are mounted in rubber to eliminate vibration. Either 10 or 12 inch records may be played. Three

watts output in both phonograph and radio insure adequate volume for most applications. A single knob controls the volume for both radio and phonograph.

The phonograph shuts off automatically when the lid is lowered,



while the radio can be used with the phonograph section either open or closed.

The Convertible is available in either ivory and ebony or in an all-ivory deluxe model which is equipped with a silent tone arm. A zippered carrying case is available for easy portability.

Further information will be supplied by Remler Company, Ltd., 2101 Bryant Street, San Francisco 10, California.

#### DIRECT VIEW TV UNIT

General Electric Company recently introduced their new direct view television receiver to the trade.

This unit which includes both AM and FM radio and an automatic record player in addition to television reception has been designated as the Model 802.

The receiver uses a 10 inch cathode-ray picture tube and incorporates a separate circuit for each of the 13 television broadcast channels which can be selected by merely turning a rotary switch to the desired channel.

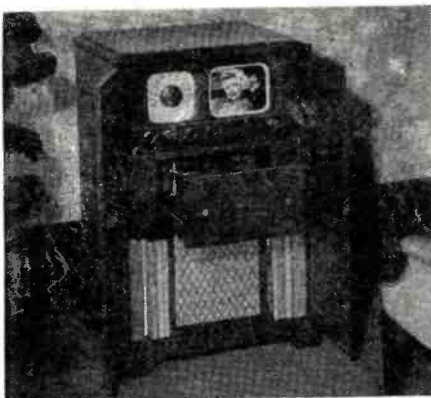

The automatic clarifier, used in this receiver, provides sharp, clear pictures, reduces interference materially and virtually eliminates fuzzy picture edges, according to reports from the company.

General Electric Company's Receiver Division, Bridgeport, Conn. will provide full details on the Model 802 upon request.

-30-

September, 1947

# Every Radio Serviceman Needs This FREE

## AC-DC BALLAST TUBE MANUAL

68 PAGES

To get YOUR FREE COPY of this indispensable manual (value \$1.50) merely mail in to JFD Factory 12 flaps from JFD Radio Dial Belt envelopes; include 10¢ in postage to cover mailing cost. (Buy your JFD Dial Belts and Belt Kits from your nearest parts jobber.)

JFD's new 68-page Ballast Manual is a treasury of information for Radio Servicemen and Dealers — AND IT'S FREE! It lists more than 3000 radio ballasts — ACDC Ballasts for Fluorescent lights and electrical appliances — 220 volt to 110 volt Stepdown Ballasts.

Be sure to include 12 flaps from JFD Radio Dial Belt Envelopes with your request for your copy of this valuable booklet.

Send 12 Envelope Flaps to:

**J.F.D. MANUFACTURING CO. INC.**

4109-4123 FORT HAMILTON PARKWAY, BROOKLYN 19, N. Y.

### AVAILABLE NOW FROM STOCK

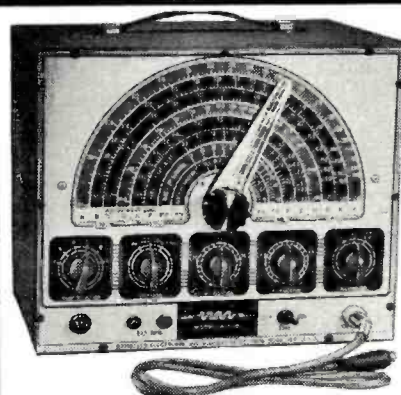

#### SIGNAL GENERATOR

Range from 100 kc. to 75 mc. Multicolor dial has eight scales in color for easy reading. Large plastic pointer assures fine frequency tuning. Handsome gray crackle finish metal case is ruggedly built for absolute stability. **\$34.95**

B2880—While they last...

Write for New Free Price Bulletin



731 West Washington Boulevard  
DEPT. N CHICAGO 6, ILLINOIS

### NEW 10 INCH TELEVISION

With Electro-Magnetic Scanning and Focusing



A Television Kit we can recommend with complete confidence that YOU will be thoroughly satisfied with the results—because we have had several of these kits assembled and tested by young men of average radio experience.

The new TTI interlock circuit for horizontal and vertical synchronizing control holds the picture steady, even at low signal strength and at noisy locations. Three separate power supplies (including the 10,000 volt supply for the ten inch picture tube) effectively prevents interaction between circuits. Sound channel is true F.M. without distortion. Pre-tuned I.F. Coils make alignment a simple matter. Switching arrangements for five bands are included. Uses 18 tubes. In stock for immediate delivery. Complete set of tubes...\$64.50. Cabinet...\$29.50

#### "RIG FAST" FDR-3 TV ANTENNA

An All Aluminum, fully assembled Folded Dipole with Reflector Antenna that is ready for service in a few minutes. Uses 300 ohm transmission line. **\$11.40**

AMPHENOL Twinex 300 ohm, per ft. **3¢**

**W H O L E S A L E**  
**RADIO PARTS CO., Inc.**  
311 W. Baltimore St.  
**BALTIMORE I, MD.**

# TRANSVISION

## TELEVISION KIT Basic Components

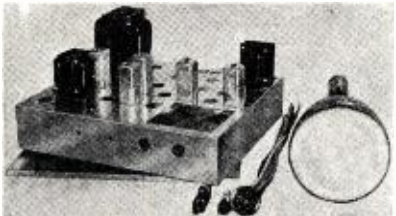

Transvision now offers the following basic components for use in building your own high quality television receiver:

- (1) Transvision Television Chassis. Heavy duty, completely punched. Net \$7.95
- (2) Transvision R.F. Unit. Completely wired and factory tuned for 3 channels, with provision for extra channels. Net \$22.90
- (3) Transvision Coil Kit (FM sound). Net \$10.75
- (4) Transvision Low Voltage Transformer with four secondary windings. Net \$9.95
- (5) Transvision High Voltage Transformer. Net \$6.30
- (6) Transvision Filter Choke. 20 henrys, 30 MA, 2000 volt insulation. Net \$1.48
- (7) Transvision Filter Choke. 10 henrys, 175 MA, 2000 volt insulation. Net \$3.50
- (8) Transvision Front Panel for 7" Cathode Ray Tube. Net \$2.95
- (9) Transvision Cabinet. Rubbed wood furniture finish. Completely drilled. Net \$29.95
- (10) Lectrovision Type 7EP4-7" Cathode Ray Tube. Net \$23.00
- (11) Transvision Complete Manual of Instructions. Net \$1.25

See your local distributor, or for further information write to:

**TRANSVISION, INC.** Dept. R.N.  
385 North Ave., New Rochelle, N. Y.

## Get a new UNGAR ELECTRIC SOLDERING IRON

# FREE

... and assemble your own  
**MAGI-KLIPS**

RADIO & ELECTRONIC EXPERIMENTER'S KIT



This is the same MAGI-KLIPS Kit—complete with all parts—that we sell ready assembled for \$29.75.

In knocked-down form with full instructions for assembly, it is now available at the new low price **\$19.75**... complete with an Ungar Electric Soldering Iron—the ideal iron for wiring your unassembled MAGI-KLIPS Kit.

Remember, you build 18 different experiments with your MAGI-KLIPS Kit. You actually teach yourself radio and electronics and have a lot of fun at the same time.

RADIO RECEIVER, HOME BROADCASTER, PHOTOELECTRIC RELAY, CODE PRACTICE OSCILLATOR, SIGNAL TRACER, REMOTE CONTROL RELAY, Phonograph Transmitter, Inter-communication Amplifier, Code Transmitter, Radio Frequency Oscillator, Telephone Line Amplifier, Electronic Switch, Phonograph Amplifier, Temperature Control Relay, Contact Detector, Electronic Metronome, Interval Timer (one-shot), Interval Timer (repeating).

Send for your copy of FREE booklet, "Electronics Made Easy."

**DEER & TAYLOR COMPANY**  
Dept. N 1340 Milvia St. Berkeley 9, Calif.

# Classified

Rate 20c per word. Minimum 10 words.

## RADIO ENGINEERING

RADIO Engineering Broadcasting, Aviation and Police Radio, Servicing, Marine Operating and Electronics taught thoroughly. Expenses low. Write for catalog. Valparaiso Technical Institute, Dept. N, Valparaiso, Ind.

## FOR SALE

CIRCUIT diagrams conversion instructions BC-453, BC-454, BC-455. AN/ARC5 190-9100 kilocycle receivers. Professional drawings. All for \$1.00. C. Reber, 47 West 58th, Kansas City, Mo.

MOTORS! Brand new, pre-war, 110V, 1P.H., A.C. Bargain! Send \$1.00. Alko Labs, 333 E. 95th St., New York City 28, N. Y.

NEW and used Hallicrafters, National, Hammarlund, Collins, RME, Pierson, Millen, Temco, Supreme and all other receivers, transmitters, parts. Lowest prices. World's best terms financed by me. Reconditioned receivers: S38 \$35.00, S20R \$59.00, S40 \$69.00, SX42 \$199.00, RME-69 \$79.00, RME45 \$99.00, SX24, SX25, SX16, SX17, SX28, SX28A, HQ129X, SPC400X, SPC400SX, HRO, NC240D, NC173, others. Terms available. Shipped on approval. Send \$5.00. Pay rest C.O.D. Write: Henry Radio, Butler, Mo.

INTER-COM cable, two pair (Army Spiral-Four), stranded copper, rubber covered, reinforced steel braid; 1320 feet per steel reel; ideal any type electronic wiring. Ames Supply Company, 3956 Pennsylvania Avenue, Northwest, Washington, D. C.

CHANGERS Intermix V.M. \$15.95, 2 for \$29.95. Service Radio, 1312 W. Atkinson, Milwaukee, Wis.

CHASSES; aluminum; built to order. 17x13x3; \$2.50. Other sizes, other prices. Send specifications for quotations and folder. John Heim, 713 W. Third St., Williamsport, Pa.

F. M. WALKIE Talkie (B.C.1000A) with 18 tubes, 2 antennas, hand set and ear phones, 42 to 48 Mc. Easily converted to 6 meters. Shipping wt. 62 lbs. Price, \$29.50. S.C.R. 610 (B.C. 659J) Portable F.M. Transmitter and Receiver, 14 tubes, antenna, built in loud speaker, 120 Crystals, etc. With vibrator and battery supply for 6, 12, 24 volt D.C. Frequency range 27 to 39 Mc. Shipping wt. 127 lbs. Price \$59.50. Used, sold as are, F.O.B. A&N Supply Company, Richmond, Va.

WIRE recorder magazine. Limited quantity, made for Army, and Air Corps. New, includes 10,000 feet stainless steel wire, spools, level-wind, brake control, automatic switches, elapsed time indicator, etc. in a fully assembled, dust-proof unit. Price \$45.00. McCoy Sales Co., P.O. Box 335, Berea, Ohio.

LOWEST Prices. Radio Tubes, parts. Bargain lists 3c. Potter, 1314 McGee, Kansas City 6, Mo.

SELENIUM Rectifiers, full wave, 1/2 ampere, \$1.85; 1 ampere, \$2.50. Half wave 5 amperes, \$4.50; 2.2 amperes, \$2.25; 1.5 ampere, \$1.85. Bulletin. Bursma Radio, Route 5, Grand Rapids, Mich.

FREE wholesale bulletin. Tubes, parts. Bargain prices. Henshaw Radio Supply, 3313 Delavan, Kansas City, Kansas.

RADIO Tubes—Dealers, order your needs—be surprised at prices. Address Radio Tubes, Box 108, Elizabeth City, N. C.

WRITE Dept. RN18 for our free wholesale list of Radio parts & accessories. R. C. Radio Parts & Distributing Co., 731 Central Ave., Kansas City 6, Kansas.

NEW bulk tubes 39c each: 1R5, 1R5, 1T4, 1A3, 1L4, 3A4, 3S4, 2Y2, 5Y3gt, 6AL5, 6SL7, 6SD7, 7E5, 12H6, 12A6, 12SLigt, 80, 31, 35W4, 12J5gt, 89. Sylvania 14A7, 14Q7, 14B6, 14J7, 35Y4, 50A5, 0Z4, 69c each. Henshaw Radio Supply, 3313 Delavan, Kansas City, Kansas.

REAL Buy! New PM dynamotors. Guaranteed output without overheating, 240V. 100MA. with 6.3v. input. Many already powering ARC5 and SCR522 conversions. Designed 12/24v. input, 500v. output. Factory sealed. \$4.50 F.O.B. 12 lbs. E. H. Pallme, 375 Oak Pl., Mineola, N. Y.

KILOWATT Amateur PA kit, Kilowatt CW, 750 watts phone, with tube and set of B&W coils for any band 10 to 80 meters, \$49.50. Kilowatt phone, CW or linear amplifier kit, complete \$69.50. Power supply kit for kilowatt phone, \$69.50. High Power Equipment Co., 75 Garfield St., Cambridge, Mass.

QUARTZ crystal blanks, unmounted crystals, electrodes, and holders for crystal manufacturers and amateurs from a large factory in Brazil, where the best Quartz Crystal is mined. Ask for Bulletin 1-47, address Radio Cristais Do Brasil Ltda., P.O. Box 1965, Rio de Janeiro, Brazil.

BARGAINS! Meters, all brand new and guaranteed: G.E. 0-50 mil., 2 1/2" rd., \$2.65; Cramer elapsed time, 3 1/2" rd., \$3.95; W.E. 0-80 mil., 3 1/2" rd., \$2.65; W.E. D.B. —4 to +8, 3 1/2" rd., \$4.95; Marion Inst., 0-1 K.V., 2 1/2" rd., \$2.65; Triplett 0-150 mil., 2 1/2" sq., \$2.95; Westghese, 0-800 mil., 3 1/2" rd., \$3.35; Sangamo Weston 0-1, 2 mil., 2 1/2" rd., \$2.65; J.B.T. 46-64 cycles freq. meter, \$3.95. Relays, brand new, all 110 V. 60 cy. coils: Dunco DPST, 6A, \$1.35; Dunco DPDT, 6A, \$1.65; Leach DPST 6A, \$1.25; Advance DPST, 10A, \$1.45. Capacitors: 8mfd. 2000 V., \$2.95. Transformers: Kenyon 2.5 V., 10 A. H.V. ins., \$3.95; Scope trans., \$4.95. Tubes: 807, \$8.85; 810, \$3.45, 814, \$3.95. Beam Antenna Cable 9 cond. #16 heavy duty rubber covered, 20c per ft. Panoramic Adaptors type AN/APA-10 for use with AN/ARR-7 and AN/ARR-5 receivers. 110 V. 60 cycle operation, \$97.50. Synchro Generators, Diehl, size 5, brand new in original containers, 110 V. 60 cy. plus 5 1/2" plastic compass card giving points of compass and 360° points. Per pair, \$13.75. Ideal for beam antenna systems. Electronicraft, Inc., 5 Waverly Place, Tuckahoe 7, New York. Phone Tuckahoe 3-0044.

WIRE recorder magazine. Made for Army. New, unused, 10,000 feet stainless steel wire, spools, level wind, automatic switches, etc. \$37. Al Ho-zempa, 709 Main St., Kingston, Pa.

LOCAL Tuning Control Knobs for SCR 274-N "Command" series receivers. Order 3 for \$1.00, get special tool kit free. Prospect Radio, 310 Prospect, Council Bluffs, Iowa.

RADIO tubes below list price, modern and old-type. Free list. Belltone Radio, 167-04 III Ave., Jamaica, N. Y.

## WANTED

TELETYPEWRITERS used or new, parts, accessories. Box 447, % Radio News, 185 N. Wabash Ave., Chicago 1, Ill.

TRC7 RADIO Equipments, RT-53 Receiver-Transmitters, AS-12 Antennas, Box 448, % Radio News, 185 N. Wabash Ave., Chicago 1, Ill.

WESTERN Electric Carrier Telephone or Telegraph Filters, equalizers, repeating coils, etc. Also CF1 and CF2 carrier equipment and parts. Box 450, % Radio News, 185 N. Wabash Ave., Chicago 1, Illinois.

W E or Kuthe Type 394A Grid Controlled Rectifiers. Box 451, % Radio News, 185 N. Wabash Ave., Chicago 1, Illinois.

## CORRESPONDENCE COURSES

USED correspondence courses and educational books bought, sold, rented. Catalog free. Educational Exchange, Henagar, Ala.

CORRESPONDENCE Courses and self-instruction books, slightly used. Sold. Rented. Exchanged. All subjects. Satisfaction guaranteed. Cash paid for used courses. Complete information and 100-page illustrated bargain catalog FREE! Write Nelson Company, Dept. 59, Chicago 5, Ill.

USED Correspondence Courses and Educational Books sold or rented. Inexpensive. Money-back guarantee. Write for Free Catalog listing 4000 bargains. — (Courses Bought.) — Lee Mountain, Pisgah, Ala.

AMATEUR radio licenses. Complete code and theory preparation for passing amateur radio examinations. Home study courses. American Radio Institute, 101 West 63rd Street, New York City 23.

## SITUATIONS WANTED

ANNOUNCER. Veteran trained by CBS men in oldest broadcasting school in country. Will try anything. Photo and disc. M. Sandberg, 1032 N. Wells, Chicago 10, Illinois.

## HELP WANTED

WANTED Servicemen also Service Organizations for television sets in all television cities from New York to Los Angeles. Experienced. Apply in writing describing experience in full. United States Television Mfg. Corp., 3 West 61st Street, New York 23, N. Y.

WRITE: RRR (Employment Bureau), Box 413, Philadelphia, for registration application.

INSTRUCTORS in Radio-Electronics and Television. Prefer former Navy Radio Technician Instructors with Teacher Training. Must be willing to locate in Detroit, Mich. Write to Box 452, % Radio News, 185 N. Wabash Ave., Chicago 1, Ill.

## PATENT ATTORNEYS

PATENTS—U.S. and Foreign Patents Secured. Trade-marks and Copyrights registered. Searches made to determine Patentability and Validity. Patent, Trade-mark and Unfair Competition Causes. Lancaster, Allwine & Rommel, Registered Patent Attorneys, Suite 414, 815 15th St., N.W., Washington 5, D. C.

MISCELLANEOUS

RADIO workers and experimenters will get many helpful new ideas from Practical Wireless, Britain's leading radio monthly. This journal contains details of latest British radio and television developments, fully explained by experts. Constructional details of all types of radio receivers are a feature. Important circuits are described and analyzed with explanatory diagrams and drawings. Other features include comprehensive blueprint service, free advice bureau, Trade news, and valuable help on every kind of radio problem. Indispensable to the practical radio man who wants to keep ahead. Annual Subscription \$2.00 from Subscription Dept. PW 3, Tower House, Southampton Street, Strand, London, W.C.2, England.

T-23/ARC-5 TRANSMITTER dope and diagrams. Many pages for \$1.00. Radio WIGBY, South Lincoln, Mass.

ELECTRIC meter laboratory Electrical instruments, tube checkers, and analysers repaired, checked and calibrated. Prompt and reliable service guaranteed. Hazelton Instrument Co., 140 Liberty St., New York 6, N. Y. Tel. Barclay 7-4239.

ELECTRICAL Instruments. All makes and models repaired. Correspondence invited. Haledon Elect. Instrument Co., 319 Belmont Ave (Haledon), Paterson 2, N. J.

WHOLESALE Radio Service at reasonable rates, quick service, no job too big. Write for full information. Elkins Radio, Elkins, W. Va.

PHONOGRAPH records cheap. Catalogue sent free. Paramount, ND-313 E. Market, Wilkes-Barre, Pa.

RADIOMEN, servicemen, beginners. Make more money, easily. \$250 weekly possible. We show you. Information free. Merit, 216-32R 132nd Ave., Springfield Gardens 13, New York, N. Y.

25 YEARS experience radio repairing at your fingertips. I've repaired 45,000 radios and have perfected system you can follow step by step. My methods are far simpler than any course published. Requires no calculations. Total price \$1.00 postpaid or C.O.D. Moneyback guaranteed. Ross Radio Company, 14615-C Grand River, Detroit 27, Mich.

**A MUST book for  
amateur and serviceman  
TWO-WAY RADIO  
BY SAMUEL FREEDMAN  
506 Pages of Facts  
Mechanics—Equipment—Application  
Actual Installations**

An excellent book for planners and users of two-way radio communication. Gives concrete answers to practical questions: How is it used? How is it installed? How is it maintained and repaired? Gives components and operation of mobile and fixed stations. Gives construction and equipment details, in accurate, complete and usable form.

\$5.00 Direct From The Publisher.  
**Ziff-Davis Publishing Company**  
185 North Wabash Ave., Chicago 1, Ill.

**COMMERCIAL RADIO INSTITUTE**

A RADIO TRAINING CENTER FOR 27 YEARS  
Resident Courses Only • Broadcast, Service, Aeronautical, Television, U.H.F., Preparatory Course. Frequency Modulation, Radar and Marine telegraphy classes forming for Fall Term Oct. 1. Entrance examination Sept. 15.

Literature upon request. Veteran training  
Dept. A, 38 West Biddle St., Baltimore 1, Maryland

September, 1947

**V.F.O. Exciter**  
(Continued from page 51)

ing since the VR150 and additional dropping resistors and bypasses following the filter proper deliver pure d.c. The filament transformer for the HY615 is a separate job of 3 amp. rating and it feeds no other tubes. The other power supply is a simple one using a 250 mil. transformer with a suitable filament winding for the 6L6 and the 1852 (6AC7) stage. A single input choke and a 4  $\mu$ d., 600 v. oil-filled filter is sufficient for these stages. The two line chokes and the four line bypasses shown in the rear center of the under-chassis are a very necessary and effective means of keeping the r.f. where it belongs. These, plus good bypassing and r.f. chokes in all critical places in the unit, good grounding, and over-all shielding will insure trouble-free performance.

The exciter delivers a beautiful clear note down to and including 10 meters. Stability is excellent. Tests made with a local monitoring station showed no sign of hum, r.f. feedback, or instability on ten meters.

All in all, the ability to pick any spot, in any of the four bands from 10 to 80 meters, with ease and speed made the time and effort expended on building this exciter well worthwhile.

-30-

**A BETTER CLICK FILTER**

By J. D. GALLAGHER, W5HZB

SINCE key click filters are used to reduce the interference caused by sparking at the contacts of the key or bug, it is best to place such filters as close to the source of interference as possible—usually at the key or bug terminals. Another very good method of reducing this type of interference is shown in the accompanying diagram.

First remove the wires connecting the dash and dot contacts to the ungrounded terminal. Connect one r.f. choke from the dash contact to the "hot" terminal, then another r.f. choke from the dot contact to the "hot" terminal as shown in the diagram. Make these leads as short as possible. Place a 50 ohm resistor on the "hot" terminal and in series with it place a .02  $\mu$ d. condenser to the grounded terminal of the bug.

This is not a new method of removing interference caused by sparks at contacts, but it is a good one. Some high speed teletypewriters use a similar arrangement to reduce interference in nearby receivers.

-30-

Wiring diagram for key click filter.

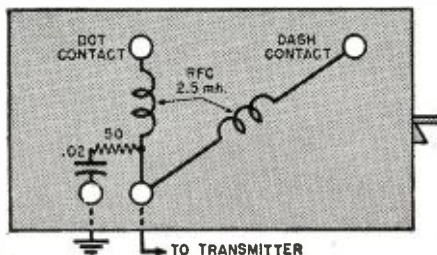

**RADIO-ELECTRONIC  
SCOOPS  
from  
MID-AMERICA**

**Order by Mail While  
Limited Quantities Last!**

Listed here are a few of the hundreds and hundreds of radio and electronic bargains Mid-America has to offer right now! Order direct from this ad for quick delivery, and ask for Mid-America's great, new catalog that lists many other big buys just like these!

**COMPLETE PHONO AMPLIFIER KIT**—wired amplifier with tubes 35W4, 12AT6 and 50B5, on-off switch, volume control and output transformer; 115-volt AC or DC operation. Astatic pick-up arm with L72-A crystal for 10" and 12" records. 78-rpm rim-drive motor and turntable. 3 1/2" PM speaker... **\$11.95**

Wired amplifier only, complete with tubes... **\$4.95**

**SCOOP! BC-654 TRANSMITTER-RECEIVER**—slightly used but in good condition. Complete with full set of tubes and spares, less power supply... **\$12.50**

**SCR-518 ABSOLUTE ALTIMETER**—complete equipment with tubes, power supply, scope indicator, etc... **\$49.50**

**MARKER BEACON RECEIVER BC-1023-A**, with tubes (6SQ7, 6U6GT, 6SC7, 12SH7). 12-14 VDC input... **\$4.45**

**POWER SUPPLY — BATTERY CHARGER**. 13-14 VDC at 10-13 amps from 115 V, 60 Cy input. Used as low voltage supply or to charge two 6-volt batteries in series. AC cord and battery cord set with clips... **\$29.50**

**INDICATOR AMPLIFIER**—15 tubes (3-6SL7, 3-VR-105, 7-6SN7, 1-5Y3, 1-8016). Chassis loaded with valuable parts. Has compact high speed motor and blower (22-30 VAC)... **\$19.95**

**SPARE PARTS CHEST**—53 popular tubes, hundreds of resistors and condensers, transformers and chokes, wired amplifier with 115 V, 60 Cy power supply, plugs, switches, connectors, cables, hardware, sockets, etc. Hardwood cabinet 30 1/2 x 30 1/2 x 32 1/2 with storage compartments and five 20" drawers makes work-base... **\$49.50**

**ORDER NOW!** Send 25% deposit with orders. We ship fastest possible way C. O. D. for balance and shipping charges. Send orders to Mid-America's store address. Address orders to Desk E-97.

**FREE CATALOG**

Rush your name and address for Mid-America's great new catalog that lists thousands of items at prices that defy competition. Get your name on our mailing list for monthly bulletins that keep you up-to-date on the latest bargains in top-quality radio parts, and electronic equipment. Address requests to Desk E-97.

**MID-AMERICA CO. Inc.**

STORE 2412 S. MICHIGAN AVE. CHICAGO 16, ILL. WAREHOUSE 2307 S. ARCHER AVE. CHICAGO 16, ILL.

# FREE

## RADOLEK

### RADIO & ELECTRONIC PARTS BUYING GUIDE

Up-to-the-Minute  
Buying  
Information

- Radio Repair Parts
  - Sound Systems ● Tools
  - Kits ● Phono Equipment
  - Tubes ● Test Instruments
  - Experimenters' Supplies
- REGULAR SUPPLEMENTS  
KEEP YOU POSTED**

Catalog sent immediately upon request. Price and Data Supplements, issued regularly, assure you of up-to-the-minute information—give exact and current data you need for profitable buying. Send the coupon today for this helpful buying service.

**BIG VALUES, LARGE STOCKS,  
FAST, DEPENDABLE SERVICE.**

## FREE...SEND TODAY

RADOLEK CO. Dept. B130  
601 W. Randolph St., Chicago 6, Ill.  
Please send your Free Profit Guide Catalog and regular Supplements.

Name .....

Address .....

City ..... Zone ..... State .....

## SAVE AT RADOLEK



**REVOLUTIONARY NEW INSTRUMENT  
FOR COMPLETE RECEIVER TESTING!**

Clippard Instrument Laboratory

# Signalette

**MULTI-FREQUENCY GENERATOR**

Generates R.F., I.F. and AUDIO Frequencies. 2500 cycles to over 20 megacycles, using new electronic multivibrator radar principle. Completely self-contained—fits coat pocket or tool chest. Just plug into A.C. or D.C. line and check receiver sensitivity, audio gain, R.F. and I.F. alignment, auto radio aerial peaking, shielding, breaks in wires, surge by stage signal tracing, tube testing by direct comparison, etc., etc. Sturdy construction, handsome appearance! See at your dealers or write for details.

**PRICE \$9.95**  
AT DEALER OR F.O.B. CINCINNATI

**CLIPPLARD INSTRUMENT LABORATORY, INC.**  
1125 Bank Street  
Cincinnati 14, Ohio

## INDEX OF ADVERTISERS September, 1947

Advertiser	Page	Advertiser	Page
Abell Distributing Company, The	154	General Electric	179
Acme Electronics	170	General Electric Company	31
Alliance Mfg. Co.	2nd Cover	General Electronic Distributing Co.	19
Allied Radio Corp.	9, 77	General Industries, The	98
Almo Radio Company	176	General Test Equipment	160
American Merchandise Mart, Inc.	152	Goodheart, R. E.	153, 176
American Phenolic Corp.	131	Greenlee Tool Co.	100
American Radio Institute	160	Greenwich Sales Co.	104
American Radio Supply Co.	139		
American Sales Company	174	Haldorson Company, The	142
American Surplus Products Co.	146	Hallcrafters Company, The	5
American Television Labs., Inc.	109	Hallmark Electronics Corp.	154
American Television & Radio Co.	151	Hammarlund Mfg. Co., Inc., The	29, 104
American Volume Control Corp.	178	Handeas Company	178
Amperex Electronics Corp.	16	Hanlan Company	165
Amplifier Corp. of America	154, 163, 180	Harvey Radio Company, Inc.	28
Apex Video	169	Heath Company, The	88, 89
Arrow Sales, Inc.	84, 85	Henry Radio Stores	161
Ashe, Walter, Radio Co.	105	Hershel Radio Company	126
Audel Publisher	120	Highbridge Radio-Television & Appliance Co.	140
Automatic Radio Mfg. Co., Inc.	179	Hi-Par Products Co.	167
		Hollywood Sound Institute	138
Baltimore Technical Institute	138		
Beacon Television, Inc.	112	Instructograph Company	144
Bell Telephone Laboratories	13	International Resistance Company	101
Best Vibrator Company	162, 185		
Bliss Electrical School	176	Jensen Manufacturing Co.	26
Boland & Boyce, Inc., Publisher	69	J. F. D. Manufacturing Co.	181
Bonafide Radio Co.	178	Joseph, Irving	129
Brach, L.S., Manufacturing Company	153		
Brooks Radio Distributing	157	Klein, Manuel	136
Brush Development Co.	127		
Bud Radio, Inc.	20	Lafayette Radio	104, 159
Buffalo Radio Supply	86, 87	Lake Radio Sales Co.	124
Burlington Instrument Company	132	Leeds Radio Co.	112
Burnell & Company	107	Leotone Radio Co.	78
Burstein-Applebee Co.	145	Lincoln Engineering School	172
Buyers Syndicate	159	Lyell Hardware	162
C-B Mfg.	134	Maquire Industries, Inc.	15
Candler System Co.	174	Mallory & Co., Inc., P. R.	71, 3rd Cover
Cannon Electric Development Co.	90	Maritime Switchboard	164
Capital Radio Engineering Institute	24	Martin School of Radio Arts, Don.	124, 159
Centralab, Division of Globe-Union	10/11	Maspeth Telephone & Radio Corp.	155
Certified Television Lab.	169	Melville Radio Institute	119
Chicago Industrial Instrument Company	98	Merit Coil & Transformer Corp.	18
Chicago Transformer, Division of Essex Wire	33	Merit Radio Supply Co.	176
Chief Electronics	116	Metropolitan Electronic & Instruments Co.	35, 131
Christy Supply Company	112	Metro Radionic Co.	179
Cleveland Institute of Radio Electronics	97	Mid-America Co., Inc.	183
Clippard Instrument Laboratory	184	Miles Reproducer Co., Inc.	116
Coastwise Electronics Co., Inc.	128	Milwaukee School of Engineering	174
Collette Products	173	Moss Electronic Distributing Co.	147
Collins Audio Products Co.	166	Munger Co., Rex L.	146
Columbia Wire & Supply Co.	136	Murray Hill Books, Inc.	30, 76, 134
Commercial Radio Institute	183	McConnell's Sound Equipment	158
Communications Equipment Co.	103	McGee Radio Company	82, 83, 141
Concord Radio Corporation	135	McGraw-Hill Book Company	158
Cornell Dublier Electric Corp.	27	McMurdo Silver Company, Inc.	80
Coyne Electrical School	34		
Coyne Electric School	122	National Company, Inc.	25
Crabtree's Wholesale Radio	121	National Engineering Service	162
Crescent Industries, Inc.	143	National Radio Institute	3
Croname, Inc.	186	National Schools	21
Crystal Devices Co.	162	Newark Electric Co., Inc.	169
		Newark Surplus Materials Co.	178
D & H Distributing Co.	96	Niagara Radio Supply Corp.	99
Davega Stores	12	Northeastern Engineering, Inc.	151
Deer & Taylor Company	182		
DeForest's Training, Inc.	17	Offenbach & Reimus Co.	133
Dow Radio Supply Co.	154	Olson Radio Warehouse	125
		Onan & Sons, D. W.	70
Eastern Electronics Sales	134	Opad & Green Company	180
Eggert Radio Institute	116		
Electro-Impulse Labs.	136	Pa-Kette Radio	178
Electro-Technical Industries	130	Par Metal Products Corp.	142
Electronic Controls Co.	142	Peerless Radio Distributors, Inc.	173
Electronic Distributors	152	Petersen Radio Company	174
Electronic Instrument Company, Inc.	118	Pittsburgh Coil Company	178
Electronic Supplies	160	Potter Radio Company	100
Electronic Technical Institute	177	Precision Apparatus	160
Electroncraft, Inc.	169	Price Radio Laboratories	170
Electronics Institute, Inc.	171	Progressive Electronics Co.	132
Embry Riddle School of Aviation	152	Pyramid Electric Company	38
Espey Mfg. Co., Inc.	116, 163		
Esse Radio Company	74, 75	Quad Electrical Supply	110
Fahnestock Electric Company, Inc.	113	R. C. Radio Parts & Distributing Co.	116
Fair Radio Sales	160	RCA Institutes	180
Federated Purchaser, Inc.	92	R-L Electronic Corp.	181
Feiler Engineering Co.	131	R & M Radio Company	94, 95
Fletcher Radio	162	Radio Corporation of America	6
		Radio Craftsman, Inc.	156
G & G Genuine Majestic Radio Parts Service	125		
G & E Equipment Supply Co.	176		
General Cement Manufacturing Co.	132		



Advertiser	Page
Radio Electric Service Co	138
Radio Equipment Company	106
Radio Ham Shack, Inc.	91
Radio Kits Company	124
Radio Maintenance Magazine	102
Radio Mart, Inc.	117
Radio Parts Company	149
Radio Press	171
Radio Shack, Inc., of Chicago, The	167
Radio Supply & Engineering Co., Inc.	111
Radiolab Publishing & Supply Co., Inc.	128
Radionic Equipment Co.	165
Radolek Company, The	100, 184
Rador Company	116
Ray-lectron Company	185
Raytone Electronic Company	134
Reed Mfg. Co.	154
Reliance Merchandising Co.	174
Remer Radio	172
Rider Publisher, Inc., John F.	32
Risco Electronics Wholesale Distributors	166

Sams & Company Inc., Howard W.	14
Scenic Radio	163
Schott, Walter Co.	144
Shur Antenna Mount, Inc.	118
Simpson Mfg. Co., Inc., Mark	155
Special Products Co.	170
Sprague Products Company	93
Sprayberry Academy of Radio	7
Stahl, Inc., Michael	114
Standard Electronics Distributing Co., Inc.	165
Standard Radio & Electronic Products	119, 159
Standard Transformer Corp.	23
Sterling Electronic Company	144, 180
Stromberg-Carlson	72
Suburban Radio Company	139
Sun Radio of Washington, D. C.	36
Supreme Instruments Corp.	148
Supreme Publications	37
Sutton's Wholesale Electronics, Bill	160
Sylvania Electric Products, Inc.	4th Cover

TAB	81
Technical Radio Parts	118
Telectron Company, The	174
Telectronics Service & Supply	168
Television Assembly Co.	147
Telex, Inc.	22
Terminal Radio Corp.	177
TIK	128
Tradio, Inc.	110
Transvision, Inc.	8, 137, 182
Tri-State College	163

U.S. Radio Supply	175
Ungar Electric Tools, Inc.	166
Universal General Corp.	176
Universal Mart Assoc. Corp.	158
Universal Recording Corp.	162
University Loudspeakers, Inc.	110

Valparaiso Technical Institute	160
Van Norman Radio Supply Co.	159
Variety Electric Company	108
Vision Research	172

W & H Sales Co.	152
Walmar Distributing Co.	138
Ward Leonard	171
War Assets Administration	115
Ward Products Corp.	79
Warren Distributors	157
Weller Mfg. Co.	106
Wells Sales, Inc.	73
Western Radio Communications Institute	161
Wholesale Radio Parts Co., Inc.	181
World Radio Laboratories, Inc.	175
Wright, Inc.	161

Zack Radio Supply	150
-------------------	-----

**10" 15" BLUEPRINTER** PRINT COPIES OF SCRIPT, SCHEDULES, ALL DIAGRAMS, AND ENGINEERING DATA. GET EXACT CORRECT COMPLETE DATA AS ORIGINAL. EASY TO MAKE PRINTS. COPIES DIRECT FROM WRITTEN, PRINTED-A-TYPED TRACINGS OR NEGATIVES. IDEAL FOR SHOP ORDERS, RECEIPT LETTERHEADS, STATEMENTS, ETC. BLUE LINE FEATURE INCLUDED. COPIES COST 2¢ PER COPY. RUSH ORDER NOW! **BEST VIBRATOR CO.** BOX 5602, CLEVELAND, 1, OHIO

## Spot Radio News

(Continued from page 20)

\$39,637,427. "During the first four months of 1947 alone," the Commerce analyst points out, "exports totaled \$31,175,055—more than five times as much as in the corresponding period of 1946 and equalling 85 per-cent of the total for the entire year 1946. If exports should continue at the same rate for the remaining eight months, the year's sale abroad would reach the amazing total of \$93,566,000. Although this figure is not expected to be achieved, a record volume of more than \$60,000,000 is practically certain."

**MR. DONNELLY REPORTS** that Latin America has tripled its prewar imports and "continues to be our best export market." Of our total receiver exports last year, 84 per-cent were picked up by eleven markets—Brazil, Mexico, China, Cuba, Union of South Africa, Canada, Colombia, Venezuela, Chile, Argentine, the Philippines. . . . Only two clouds are on the current horizon, Mr. Donnelly believes. One is the falling off of dollar credit in many foreign countries. The other is the threat of competition. Toughest competitors to watch in the immediate future—England and Holland.

**RADAR** (airborne division) got a tremendous boost the other day when Navy ordered 100 sets for transport use. The contract is worth a million dollars. It was signed with the *Houston Corporation*, Los Angeles. Specs for the new radar were worked out by Army, Navy, and American Airlines. They have been more than a year in the making. The units are light—about 150 pounds—so that they will do no serious damage to a plane's payload. They will be mounted in the plane's nose, giving the pilot a 220-degree view of what's ahead, or under the fuselage, giving a complete 360-degree radar "map." A five-inch scope will be mounted in both the pilot's and co-pilot's positions. Some of the sets will have 12-inch scopes in the radioman's compartment for navigating long water hops. The sets will pick up land a hundred miles ahead. When used with radar beacons, bearing and distances may be determined up to 225 miles. The *Houston* contract signed by the Navy is the first of its kind.

-30-

## Photo Credits

Pages	Credit
39, 43, 44, 45, 46, 140	Walter Steinhard, Staff Photographer
47	Smith & Applegate
54, 55, 60, 122	Radio Corporation of America
62	Black Box Studios
64, 120, 126	Western Electric Company
66, 67	University Loudspeakers, Inc.
68	Radio SEAC
92	U. S. Marine Corps
108	Arthur E. Haug, Staff Photographer

## Buy Our Coil Kit and BUILD YOUR OWN HIGH QUALITY 7 IN. TELEVISION SET

for approximately **\$125<sup>00</sup>**

### THE HOME CONSTRUCTOR

who wishes to build a television set able to receive 6 channels with FM sound, now has an unparalleled opportunity to use the best the market affords, at this **LOW TOTAL COST**, which **INCLUDES** purchase price of our

Complete

## TELEVISION COIL KIT

plus detailed Construction Manual

for 20 tube, 7 inch Picture Tube Television Set, for

Only **\$23<sup>50</sup>**

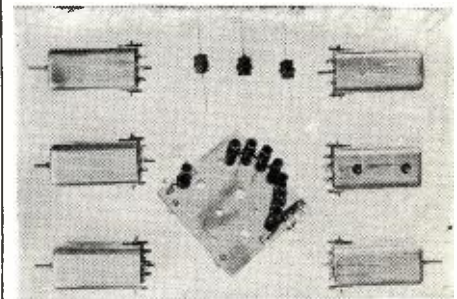

### LOOK AT THESE FEATURES!

- Video IF Bandwidth of 4.25 MC that can operate ANY size picture tube with maximum resolution.
- Five stages Video IF, permeability tuned with sound and adjacent channel rejection traps, in shielded cans.
- 6 Channel RF Tuner, permeability tuned, mounted on switch assembly plate.
- FM Sound Discriminator for TRUE FM.
- Can provide Video Operation for 10, 12, 15 or 20-inch picture tube upon further construction.
- Video Peaking Chokes to maintain bandwidth.
- Detailed Construction Manual & Parts List with every kit.
- Continued Service Bulletins.

### SATISFIED CUSTOMERS WRITE

- "Excellent bandwidth with good 'trap rejection'"
- "Thoroughly pleased and satisfied with your coil kit."
- "This manual most complete description of television receiver I have ever seen."



ORDER DIRECT OR THRU LOCAL DEALER

### TERMS

Shipped Parcel Post prepaid on receipt of check or money order. Or P.P. Collect on receipt of 25% deposit with order, balance COD.

Manual Only, \$1.00 plus 12c postage. Television parts, Deflection Components, CR Tubes in stock. Send for free listing to Dept. J.

**RAY-LECTRON CO.**  
706 Tenth Avenue  
BELMAR, N. J.

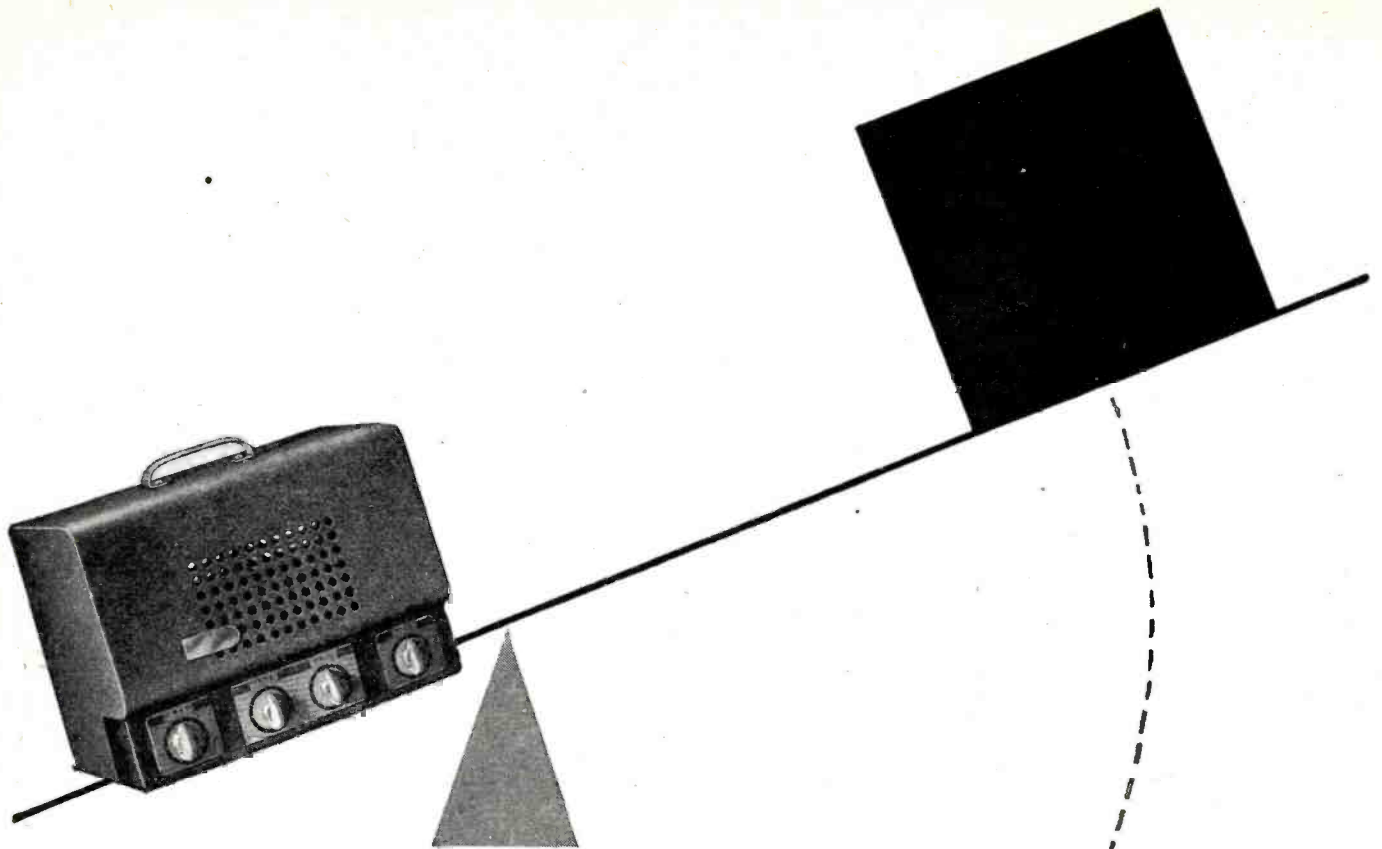

**APPEARANCE HAS WEIGHT** with most of us.  
 You can load the scales in your favor by utilizing  
 the extra buy-appeal of Croname's new CQ cases.

## CRONAME

INCORPORATED

3701 RAVENSWOOD AVE.  
 CHICAGO 13, ILLINOIS

You may send me literature on the new CQ cases.

My Name \_\_\_\_\_

Firm \_\_\_\_\_

Position \_\_\_\_\_

Address \_\_\_\_\_

City \_\_\_\_\_ Zone \_\_\_\_\_ State \_\_\_\_\_

✓ Please Check ✓

<input type="checkbox"/> Amateur	<input type="checkbox"/> Distributor	<input type="checkbox"/> Manufacturer
<input type="checkbox"/> Consulting Engineer	<input type="checkbox"/> Experimenter	<input type="checkbox"/> Service Dealer
<input type="checkbox"/> Custom Builder	<input type="checkbox"/> Industrial Designer	_____



**...sold by conveniently located distributors  
who are willing and able to help you**

There are 1700 electronic items in the Mallory catalog—vibrators—capacitors—controls—all Approved Precision Products—that have that “extra something” it takes to make a winner: **PREMIUM QUALITY!** Fifteen years of performance have proved that Mallory quality gives longer life, better accuracy, greater dependability to every job you do.

That’s why more Mallory-made vibrators are in use today than all other makes combined... why Mallory capacitors enjoy a nationwide recognition for superiority... why Mallory controls are preferred for closer tolerances and extra dependability by service engineers everywhere.

Remember that Mallory offers you Approved Precision Products in *complete* lines—lines available through conveniently located distributors who have the ability and desire to serve you well—with *premium quality* products at no extra cost.

**YOU EXPECT MORE AND GET MORE FROM MALLORY**

**P. R. MALLORY & CO. Inc.**  
**MALLORY**

VIBRATORS... VIBRAPACKS\*... CAPACITORS... VOLUME  
CONTROLS... SWITCHES... RESISTORS... FILTERS  
... RECTIFIERS... POWER SUPPLIES.

\*Reg. U. S. Pat. Off.

**APPROVED PRECISION PRODUCTS**

**P. R. MALLORY & CO., Inc., INDIANAPOLIS 6, INDIANA**



## Why the *Lock-In* Tube is at home in FM

### ULTRA-HIGH FREQUENCIES... HANDLED WITH EASE

The Sylvania Lock-In is *the* tube specifically engineered to more than satisfy the requirements of Frequency Modulation—handles ultra-high frequencies with ease! Some reasons for this electrical superiority are: short, direct connections... fewer welded joints—less loss; getter located on top... shorts eliminated by separation of getter material from elements.

### STAYS PUT IN SOCKET... MECHANICALLY RUGGED

Specially designed "lock-in" locating lug on each tube keeps it in place—assuring firm socket contact. Improved tube mount keeps elements ruggedly supported on all sides. There are few welded joints and *no* soldered joints—the elements can't warp or weave.

### COMPACT... MADE TO FIT SMALL SPACES

This famous Sylvania product is ideal for use in modern sets, where the tendency has been toward more compact units—has reduced overall height and weight. Has no top cap connection... overhead wires are eliminated! See *Sylvania Distributors* or write *Radio Tube Division, Emporium, Pa.*

# SYLVANIA ELECTRIC



### SYLVANIA'S LOCK-IN TUBE...

... the radio tube whose electrical and mechanical superiority makes it the ideal choice for FM and television, equipment in the air, on the road, marine radar.

MAKERS OF RADIO TUBES; CATHODE RAY TUBES; ELECTRONIC DEVICES; FLUORESCENT LAMPS, FIXTURES, WIRING DEVICES; ELECTRIC LIGHT BULBS